

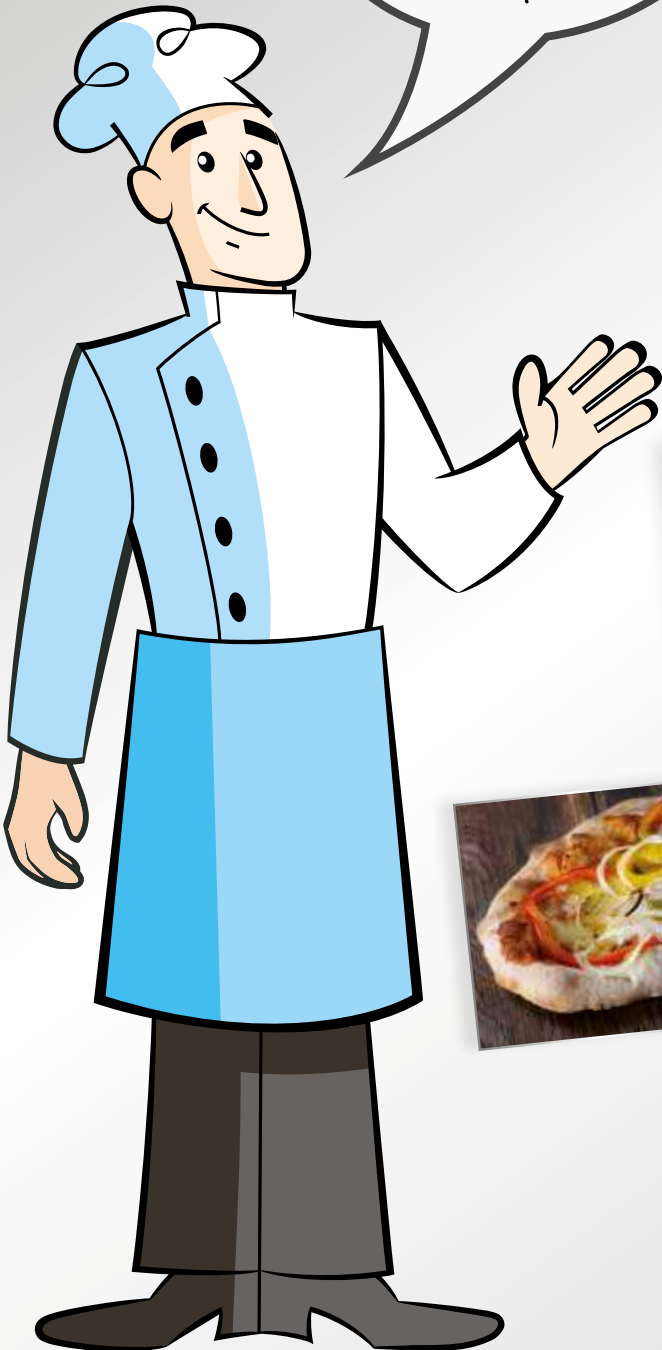

Product catalogue

The dynamic
Preparation
specialist
for more than
70 years





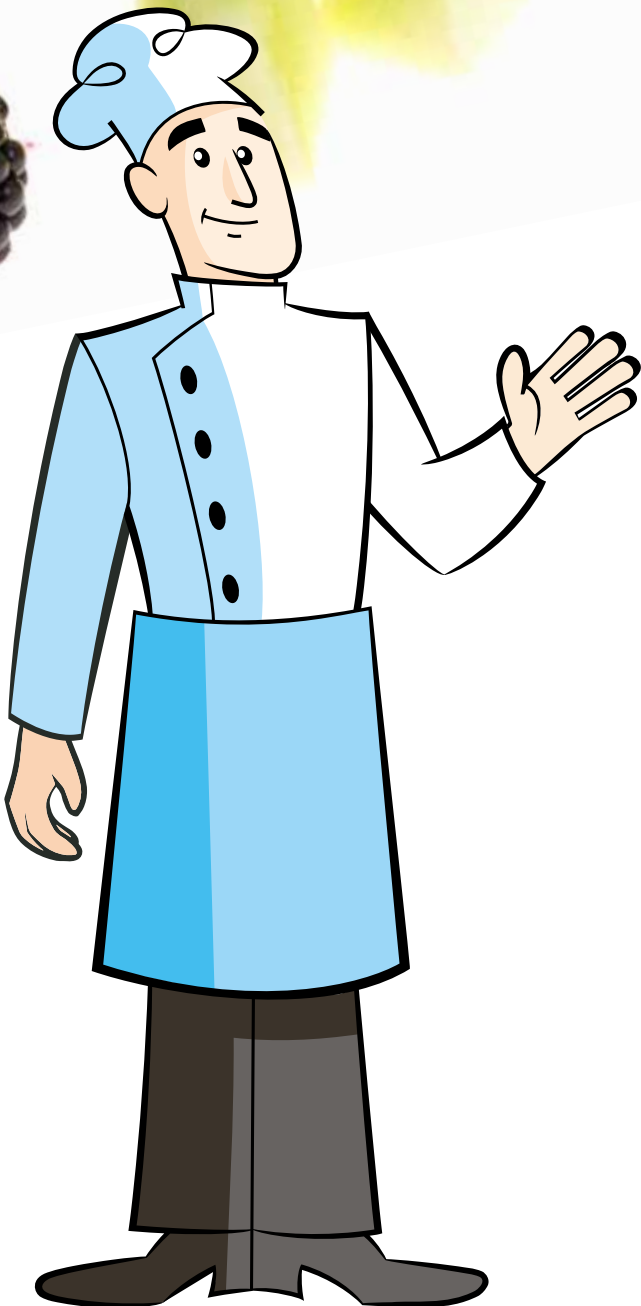

Reinforcing its main goal of staying on top of food safety, Dito Sama selects, for parts in contact with food, materials that prevent chemical migration of potentially harmful substances. In line with this policy, **Dito Sama does not use Bisphenol A (BPA)** in all plastic components of its Food Preparation products that come into direct contact.





- Combined Cutter & Vegetable Slicers page 6

- Vegetable Slicers page 10

- Food Processors page 24

- Stick Blenders and Turbo Liquidisers page 30

- Planetary Mixers page 36

- Bakery, Pastry and Pizza page 44

- [Vegetable Peelers](#) page 48

- [Vegetable Washers and Spin Dryers](#) page 52

- [Complementary Products for your Kitchen](#) page 54

- [Dough Sheeters](#) page 56

- [Food slicers, Meat mincers and Vacuum packers](#) page 58





■ Combined Cutter & Vegetable Slicers Multigreen

2 functions in 1 machine! Prepare a variety of fresh cut vegetables as well as your condiments and sauces.



Easy to use,
On/Off buttons



2,5 lt stainless
steel bowl
Transparent lid



All parts in contact with food are
100% dishwasher safe



Long vegetable
hopper
(Ø 52mm)



- **End Users:** Fast food / Delicatessen / Small Caterers / Restaurants
- **From 10 to 200 covers**



Cutter Function:

- chopping herbs and condiments, blending sauces, mincing meat / fish
- Capacity: **up to 1 kg** (e.g. mayonnaise)

Vegetable slicer function:

- fresh-cut vegetables for sandwiches and small salads
- Capacity: **up to 250 kg/h**







- Easy to move and space saving
- **Asynchronous industrial motor** for long life and silent operation
- **Speed 1500 rpm**
- **Versatile** and easy to change from a cutter to a vegetable slicer
- **Perfect balance** and design of the smooth blade rotor guarantee a **rapid** and **constant mixing**
- Opening on top of the lid allowing to add liquids and ingredients while processing
- **Wide load hopper** for better productivity
- Integrated **long vegetable hopper** to slice zucchini, carrots, cucumbers, etc.
- Continuous feeding model
- **High discharge zone** permits the use of GN containers up to 175 mm
- All parts in contact with food are **100% dishwasher safe**



Multigreen

Speed	Phases	Power	rpm
1 speed	1 ph	370 W	1500
External dimensions (WxDxH) 216x347x412mm			

Stainless steel disc Ø 175 mm	Model	Dimensions (mm)
	Grating disc RD2 RD3 RD4 RD7	2 3 4 7
	Shredding disc ED2 ED4	2 4
	Slicing disc TD2 TD3 TD5 TD7	2 3 5 7
	Disc with corrugated blades WD2	2





■ Combined Cutter & Vegetable Slicers TRK

3 in 1 ! With TRK, there are no limits to creative cooking.

Three functions: vegetable slicer, food processor, emulsifier. Three sizes: 4.5, 5.5 and 7 litres. Variable speed from 300 to 880 rpm (slicer) and up to 3,700 rpm (cutter).



Round, stainless steel hopper (215 cm²)



Flat waterproof control panel (IP55)



Long vegetable hopper (Ø 55,5mm)



Transparent lid with scraper for better consistency

Switch safely and easily from cutter/emulsifier to veg prep function, thanks to the Incky system and the automatic speed limitation device



- **End Users:** Restaurants / Public Sector / Caterers / Nurseries / Residential Homes
- **From 50 to 400 covers**
Up to **800 covers for catering service**



Cutter function:

- Coarse and fine chopping, emulsifying, kneading and mincing
- **Capacity** (e.g. mayonnaise):
TRK45: up to **2 kg**
TRK55: up to **2,5 kg**
TRK70: up to **3,5 kg**

Vegetable slicer function:

- Wide range of cuts of fruits and vegetables for cold or hot preparations
- **Capacity:** up to **550 kg/h** (depending on the cut)



- **Easy to change from a cutter to a vegetable slicer**
- **Transparent lid** equipped with scraper and central hole to add ingredients
- **Asynchronous industrial motor** for long life and silent operation
- Maximum speed up to **3700 rpm** (cutter function)
- Stainless steel bowl with high chimney to **increase** the real liquid **capacity**, with round corners and ergonomic handle
- **Dedicated rotors** with **smooth** or **microtoothed** blades as well as specific for **emulsions**
- **Large** and **long** vegetable **hoppers** integrated in the same design
- Incl System: inclined motor base by 20° for better ejection of vegetables
- **Wide range** of **stainless steel discs** (205mm diameter) for more than 80 different cuts
- All parts in contact with food are **100% dishwasher safe** (vegetable and cutter attachments, rotors and discs)



Incl System inclined base 20°



TRK45 Combined Cutter & Vegetable Slicer 4,5 lt

Speed	Phases	Power	rpm
Variable	1 ph	1000 W	from 300 to 3700
External dimensions (WxDxH) Vegetable slicer 252x485x505mm Cutter 252x410x490mm			

TRK55 Combined Cutter & Vegetable Slicer 5,5 lt

Speed	Phases	Power	rpm
Variable	1 ph	1300 W	from 300 to 3700
External dimensions (WxDxH) Vegetable slicer 252x485x505mm Cutter 252x410x490mm			

TRK70 Combined Cutter & Vegetable Slicer 7 lt

Speed	Phases	Power	rpm
Variable	1 ph	1500 W	from 300 to 3700
External dimensions (WxDxH) Vegetable slicer 252x485x505mm Cutter 252x410x530mm			





■ Vegetable Slicers Minigreen

The ideal solution for the fast preparation of fresh-cut vegetables,
saving time and money.



Wide load hopper



Long vegetable
hopper (Ø 52mm)



Ergonomic handle

STABILITY

4 rubber feet



- **End Users:** Fast Food / Bistrot / Small Caterers / Restaurants
- Up to **200 covers**



- **Main use:** slicing, grating, shredding and cut fresh vegetables for sandwiches and small salads
- Capacity: up to **200 kg/h**







- Easy to move and space saving
- **Speed 1000 rpm**
- **Asynchronous industrial motor** for long life and silent operation
- **Wide load hopper** for better productivity
- Integrated **long vegetable hopper** to slice zucchini, carrots, cucumbers, etc.
- Continuous feeding model
- **Ergonomic handle**, easy to use, easy to clean



- **High discharge zone** permits the use of GN containers up to 175 mm
- All parts in contact with food are **100% dishwasher safe**

Vegetable slicer Minigreen

Speed	Phases	Power	rpm
1 speed	1 ph	250 W	1000
External dimensions (WxDxH) 216x347x412mm			

Stainless steel disc Ø 175 mm	Model	Dimensions (mm)
	Grating disc	RD2 2 RD3 3 RD4 4 RD7 7
	Shredding disc	ED2 2 ED4 4
	Slicing disc	TD2 2 TD3 3 TD5 5 TD7 7
	Disc with corrugated blades	WD2 2





■ Vegetable Slicers TRS

Increased productivity, outstanding performance, superior quality and a sturdy design. Meets all your needs for preparing fruit and vegetables.



Round stainless-steel hopper (215 cm²)



Long vegetable hopper (Ø 55,5mm)

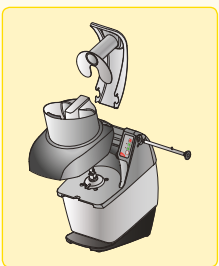

Easily dismantlable



Flat, waterproof control panel (IP55)



"Pulse" function for a precise cut



Stainless steel discs

100% dw safe: cutting chamber, stainless steel lever and hopper and all stainless steel discs and grids



- **End Users:** Restaurants / Small and Medium Size Catering Facilities / Caterers
- **100 to 400 covers** for table service
- Up to **800 covers** for catering service



- **Main use:** slicing, grating, wavy cuts, cutting into juliennes, french fries or dicing all kind of fruits and vegetables.
Capacity: up to **500 kg/h**



Grate



Chips



Corrugated slices



Cubes



- **Asynchronous industrial motor** for long life and silent operation
- **Ergonomic, easy to lift lever:** minimal pressure is required to process vegetables (for right or left hand use)



- **Maximum cleanability** due to the ergonomic design with rounded shapes.
- All parts in contact with food are **100% dishwasher safe**

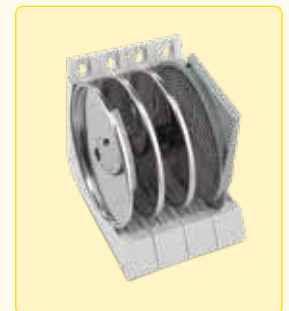
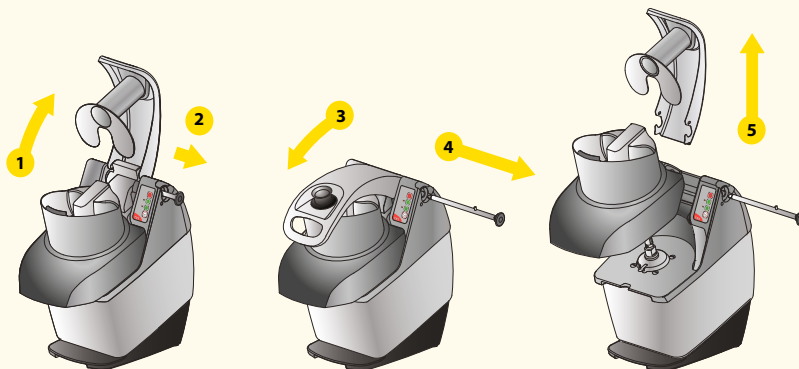

Stainless steel discs with holder included standard for a better organization in your kitchen

- **Wide range of stainless steel discs** (205mm diameter) for more than 80 different cuts
- **Inclined motor base** for better ejection of vegetables
- Easy access to the cutting chamber so the discs and ejector can be easily removed
- High discharge area for **deep GN containers** (up to 20 cm)

Vegetable slicer TRS

Speed	Phases	Power	rpm
1 speed	1 ph	370 W	340
	1 ph	500 W	340
	3 ph	500 W	340
2 speeds	3 ph	750 W	340 / 680
Variable	1 ph	500 W	140 - 750

External dimensions (WxDxH) 252x485x505mm



High discharge area for deep GN containers



■ Vegetable Slicers TR210

With its automatic hopper, the TR210 cuts large quantities of fruit and vegetables. Optional hoppers provide the flexibility to tailor the machine to meet different requirements.



Stainless steel manual hopper (optional)



Stainless steel long vegetable hopper (optional)



Incluy System
20° angled base
(for use with manual hopper)



Guaranteed ergonomics and flexibility with the new stainless steel trolley



- **End Users:** Small and medium catering facilities.
- **100 - 800 settings** for table service.
- **Up to 1000 settings** for catering service.



- **Main use:** slicing, grating, wavy cuts, cutting into juliennes, french fries or dicing all kind of fruits and vegetables.
Capacity: up to **2100 kg/h** (full speed and full load)



- **Asynchronous industrial motor** for long life and intensive use
- Model equipped with automatic hopper for high productivity especially for grating, slicing or dicing
- Removable cutting chamber : no food in contact with the motor base
- Continuous feeding model
- Table top or freestanding models, thanks to the ergonomic mobile trolley
- **100 % dishwasher safe:** cutting chamber, stainless steel lever, hoppers and discs



more info on discs at page 18

- **Wide range of stainless steel discs** (205mm diameter) for more than 80 different cuts
- **Unique and exclusive “S” shaped blades (patent pending)**
- Improved efficiency and versatility for slicing
- Superior slicing for precision cutting of hard and soft vegetables



Vegetable slicer TR210

Speed	Phases	Power	rpm
1 speed	1 ph	500 W	340
2 speeds	3 ph	750 W	340 / 680
Variable	1 ph	500 W	140 - 750
External dimensions (WxDxH) 252x485x505mm			



Slicing discs for

■ TRS/TR210 ■ TRK

Unique and exclusive “S” shaped blades for greater efficiency and versatility in slicing.
Stainless steel discs for maximum hygiene. 100% dishwasher safe.

Graters - 2 mm to 9 mm



2 mm

3 mm

4 mm

7 mm*

9 mm*

for breadcrumbs / potatoes

for parmesan / chocolate

* 7 and 9 mm discs are suitable to grate mozzarella and semi-dry cheese



Shredders - 2 mm to 10 mm



2x2 mm

3x3 mm

4x4 mm

6x6 mm

8x8 mm

10x10 mm

2x8 mm

2x10 mm



Slicers - 0.6 mm to 13 mm



0.6 mm

1 mm

2 mm

3 mm

4 mm

5 mm

6 mm

8 mm

10 mm

12 mm

13 mm



Wavy slicers - 2 mm to 10 mm



2 mm

3 mm

6 mm

8 mm

10 mm



Dicing grids* - 5x5 mm to 20x20 mm

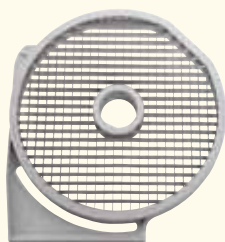

5x5 mm

8x8 mm

10x10x10 mm

12x12x12 mm

13x20x20 mm



Grids for chips* - 6, 8 and 10 mm



6x6 mm

8x8 mm

10x10 mm



* to be combined with **Slicers** and **Wavy slicers**



■ Vegetable Slicers TR260

Equipped with a wide range of accessories, the TR260 will be your partner for the success of your largest culinary events



Flat and waterproof control panel (IP55)



Automatic feed hopper (optional).
Up to 6 kg of vegetables



Stainless steel mobile stand.
Disc rack (optional)



- **End Users:** Public Sector / Small Food Industries / Central Kitchens
- **400 to 600 covers** for table service
Up to **2000 covers** for catering service



- **Main use:** slicing, grating and cutting all kind of fruits and vegetables
- Capacity: up to **2500 kg/h** (with automatic hopper)
- Capacity: approx. **700 kg/h** (with lever hopper)



- **High productivity** guaranteed with 300 mm diameter discs
- Automatic hopper for **continuous operation** and productivity
- **Asynchronous industrial motor** for long life and silent operation
- User friendly **waterproof control** panel with **pulse function** and speed selector (only on 2 speed models) for **precise slicing**
- **Maximum versatility.** Combine motor base with a variety of optional accessories to suit your needs



Lever operated hopper



Long vegetable accessory for lever operated hopper



Long vegetables hopper with 3 tubes (Ø 50 to 70mm)



Cabbage hopper to cut an entire cabbage (max. Ø 250 mm). To be combined with cabbage discs



Wide selection of discs (Ø 300 mm)



Stainless steel trolley for 2/1 GN containers

Vegetable slicer TR260

Speed	Phases	Power	rpm
1 speed	1 ph	1500 W	330
2 speeds	3 ph	2000 W	330-660

External dimensions (WxDxH) 750x380x460mm





■ Potato Chipper RC14

High output potato chipper for use in large catering kitchens and specialized chip production.



Stainless steel mobile stand (optional accessory)



Chipping block (optional accessory)



Automatic hopper with a capacity up to 1.500 kg/h (25 kg/min.)



French fries cutting block (optional accessory)

The RC14 is designed for intensive use and ensures a high level of safety to the operator.



- **End Users:** Central kitchens, specialized chip production and theme restaurants



- **Main use:** slicing and french fries cuts
- Capacity: up to **1500 kg/h**



- **Asynchronous industrial motor** for long life and silent operation
- Specific table top machine for potatoes with automatic hopper
- Compact and easy to clean
- Chipping or french fries cutting blocks available in different sizes
- Easy access to the cutting chamber to insert the cutting block
- Hopper, cutting block and rotor easily removable for cleaning (see picture on the right)



French fries

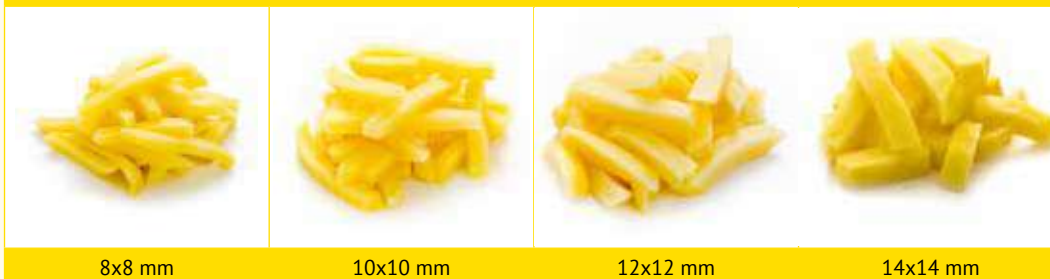

Chipping



Shape and cutting consistency granted by the Dito Sama special rotor which directs properly potatoes towards the cutting block.



■ Food Processors K25 / K35

The right choice for chopping, mixing or emulsifying.
Easy to use and heavy duty multi-purpose cutter
for small and medium size kitchens



- **End Users:** Restaurants / Small Catering Facilities
- **From 10 to 50 covers**



- Compact and versatile for professional use
- **2,5 lt stainless steel bowl**
- **Transparent lid with opening**
- **1 speed: 1500 rpm**



- **Main use:** chopping herbs and condiments, blending sauces, mincing meat / fish
- Capacity: up to **1 kg** (e.g. mayonnaise)



- **End Users:** Restaurants / Small and Medium Size Catering Facilities / Caterers
- **From 10 to 50 covers**



- **Main use:** chopping herbs and condiments, blending sauces, mincing meat / fish
- Easy to use
- **Safety:** the rotor stops immediately if the lid is opened



- **3,5 lt** stainless steel bowl
- 2 speeds : **1500** and **3000 rpm**
- Capacity: up to **1,8 kg** (e.g. mayonnaise)



K35



Transparent lid K35



Stainless steel bowl



- **No need to stop the machine during operation.** Ingredients may be added through a funnel shaped opening incorporated in the lid
- All parts in contact with food can be **easily disassembled** without tools and are **100% dishwasher safe**
- **Asynchronous industrial motor** for long life and silent operation
- Rotor and bowl design ensure **consistent mixing every time**
- **Operator safety guaranteed.** A magnetic control system stops the machine immediately if the cover is opened

K25 2,5 lt capacity

Model	Speed	Phases	Power	rpm
K25	1 speed	1 ph	370 W	1500

External dimensions (WxDxH) 216x297x371mm

K35 3,5 lt capacity

Model	Speed	Phases	Power	rpm
K35	1 speed	1 ph	500 W	1500
K35	2 speeds	3 ph	500 W	1500-3000

External dimensions (WxDxH) 247x407x303mm





■ Food Processors K45 / K55 / K70

Dito Sama's high-power food processors are built to last and can chop, mince, grind and blend any preparation required by your recipes.



**2 in 1 machine, thanks to the scraper:
consistent results in a matter of seconds.**



- **End Users:** Restaurants / Catering Facilities / Caterers / Nurseries and Residential Homes
- From **50 to 150 covers**



- **Main use:** Coarse and fine chopping, emulsifying, kneading and mincing



- **Stainless steel bowl: 4,5 / 5,5 / 7 lt**
- Capacity (e.g. mayonnaise):
K45: up to **2 kg**
K55: up to **2,5 kg**
K70: up to **3,5 kg**
- Speed: **from 300 to 3700 rpm** (see models)
- **Asynchronous industrial motor** for long life and silent operation
- Transparent and **dismountable lid attached to the body**
- **Delivered with scraper/emulsifier**
- **Dedicated rotors** with smooth or microtoothed blades as well as specific for emulsions
- All parts in contact with food can be **easily disassembled** without tools and are **100% dishwasher safe**



Holder for rotor included

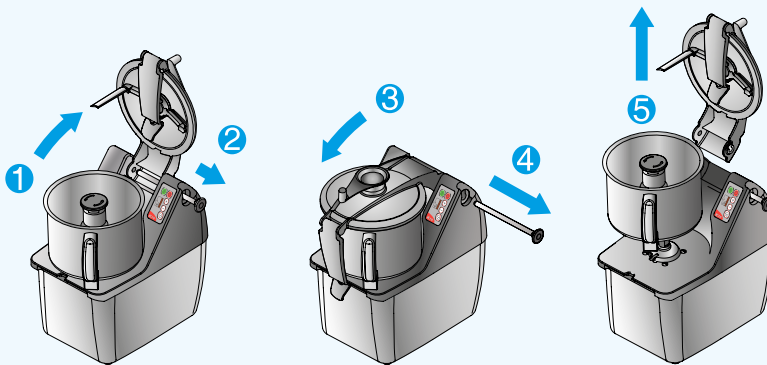

K45 4,5 lt capacity

Speed	Phases	Power	rpm
1 speed	1 ph	750 W	1500
2 speeds	3 ph	900 W	1500/3000
Variable	1 ph	1000 W	300 - 3700

External dimensions (WxDxH) **252x410x490mm**

K55 5,5 lt capacity

Speed	Phases	Power	rpm
2 speeds	3 ph	1000 W	1500/3000
Variable	1 ph	1300 W	300 - 3700

External dimensions (WxDxH) **252x410x490mm**

K70 7 lt capacity

Speed	Phases	Power	rpm
2 speeds	3 ph	1200 W	1500/3000
Variable	1 ph	1500 W	300 - 3700

External dimensions (WxDxH) **252x410x530mm**



Ground meat



Vegetable purees



■ Food Processors K120S / K180S

Mix and mince quickly and easily, while preserving the texture and flavour of your ingredients



Stainless steel bowl with leak-proof spout



Safety double lock system



K180S



Flat and waterproof control panel (IP55)



Exclusive angled-blade design ensures consistent, optimal mixing results



- **End Users:** Restaurants / Caterers / Delicatessen
- **From 100 to 300 covers**



- **Main use:** Coarse and fine chopping, emulsifying, kneading and mincing



- **17,5 lt capacity** stainless steel bowl
- 2 speeds: **1500 and 3000 rpm** (K180S)
- Variable speed available: **from 300 to 3000 rpm** (KE180S)
- Capacity: up to **8 kg** (e.g. mayonnaise)



- **End Users:** Restaurants / Caterers / Delicatessen / Catering Facilities
- From **100 to 200 covers**



- **Main use:** Coarse and fine chopping, emulsifying, kneading and mincing



- **11,5 lt capacity** stainless steel bowls
- 2 speeds: **1500 and 3000 rpm** (K120S)
- Variable speed available: **from 300 to 3500 rpm** (KE120S)
- Capacity: up to **6 kg** (e.g. mayonnaise)

Features for all models:

- “Pulse” function for a coarse chopping of large pieces (on 2 speed models)
- Rotor and bowl design ensure **consistent mixing**
- **Asynchronous industrial motor** for long life and silent operation
- Transparent lid, bowl, scraper and rotor can be **easily removed without tools** and are **100% dishwasher safe**
- **Bowl scraper for consistent results**
- **3 devices to ensure operator safety** (K/KE 120S/180S):
 - 1 hinge sensor when handle is lifted
 - 1 bowl presence sensor
 - 1 cover presence sensor



K120S



Bowl scraper

K120S/KE120S 11,5 lt capacity

Model	Speed	Phases	Power	rpm
K120S	2 speeds	3 ph	2200 W	1500/3000
KE120S	variable	1 ph	2200 W	300 to 3500
External dimensions (WxDxH) 416x680x517mm				

K180S/KE180S 17,5 lt capacity

Model	Speed	Phases	Power	rpm
K180S	2 speeds	3 ph	3600 W	1500/3000
KE180S	variable	3 ph	3000 W	300 to 3000
External dimensions (WxDxH) 416x680x603mm				



Rotors ■ K ■ TRK

Choose the perfect cutting blade for your preparation



Smooth rotor blade



Microtoothed rotor blade



Smooth emulsifier blade



Microtoothed emulsifier blade



Ground meat



Almonds



Asparagus



Hummus



Chocolate

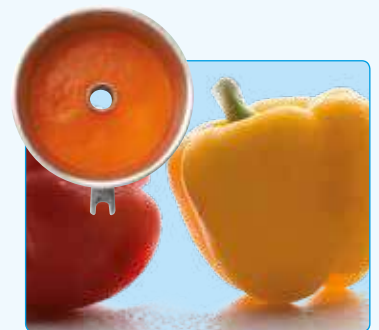

Peppers



Tomato sauce



Mixed herbs

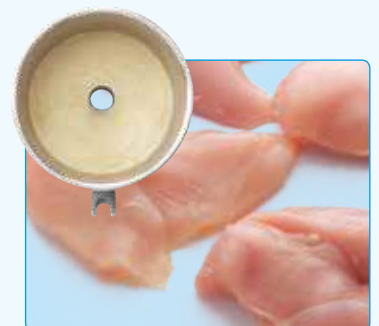

Chicken

Texture-modified food ■ K ■ TRK

High-speed, integrated bowl scraper and exclusive blade design. These three features help turn your food processor into an emulsifier that allows you to modify the texture of food while preserving its nutritional content and taste. The only limit is your imagination!



Pasta



Poultry



Microtoothed
emulsifier blade
K45/55/70



Fish



Sausage



Microtoothed
emulsifier blade
K120S



Cakes



Salmon



Microtoothed
emulsifier blade
K180S



Stick blenders Bermixer PRO

Wide range from 350 W to 750 W. The Dito Sama Bermixer PRO makes it quick and easy to prepare soups, purees, sauces and creams, and whip egg whites

less than
4 kg



Dismountable **without tools** and **dishwasher safe**

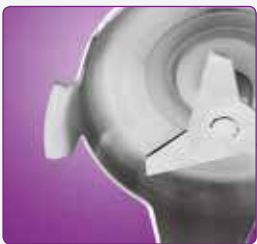

Durability guaranteed thanks to the easily removable blade that can be sharpened or replaced

up to
10 000 rpm



Smart Speed Control
SSC
System



9 speed levels automatic power adjustment



Safe handling thanks to the heat protected grip



- **End Users:** Restaurants / Catering Facilities
- **50 to 300 covers**



- **Main use:** soups, purees, sauces, creams



- Light and easy to use stick blender
- **Smart Speed Control:** autoregulation of the power to ensure a longer life and reduced vibrations
- Vortex system to process the entire preparation, no need to stir
- Control panel with **overload indicator alarm**
- Special lipped design of the blade protection **avoids splashing** aligned with the strictest regulations in terms of safety



- All parts in contact with food are **easily disassembled and 100% dishwasher safe**
- Thermal insulated plastic insert on the tube

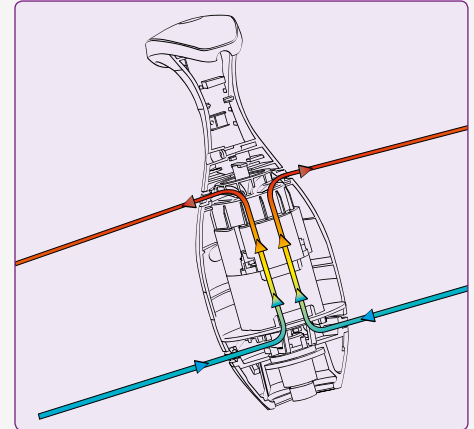

Air cooling system for longer usage without overheating



Pot holder



Supplied with wall support



Quick and easy disassembly of axe



Dismountable blade



Stick blenders Speedy Mixer

MS200 and MS250. Dynamic tools for your busy kitchen to prepare soups and creams in small quantities. Easy to use and space saving.



Dismountable **without tools**



Emulsifier tube available

15000 rpm



Ergonomic handle



Stainless steel bell,
blade and tube



- **End Users:** Restaurants / Catering Facilities
- **50 to 300 covers**



- **Main use:** soups, purees, sauces, creams



- Light and easy to use stick blender
- Available with 20 or 25 cm stainless steel tube
- Ideal for small quantities
- Optional whisk available for the variable speed models
- Emulsifier tube available
- Available with variable speed
- Thanks to the easy tool junctions, the motor unit and tube can be **disassembled without tools for cleaning**

A complete range

SPEEDY MIXER *15,000 rpm*



Models	MS200 (DSMT20W25)	MS250 (DSMT25W25)	MS200VV (DSMVT20W25)	MS250VV (DSMVT25W25)
Power (W)	250 W		250 W variable speed	
Tube (cm)	20 cm	25 cm	20 cm	25 cm
Weight (kg)	1,4 kg	1,45 kg	1,4 kg	1,45 kg
Capacity	Ideal for small quantities			

BERMIXER PRO *9,000 rpm*

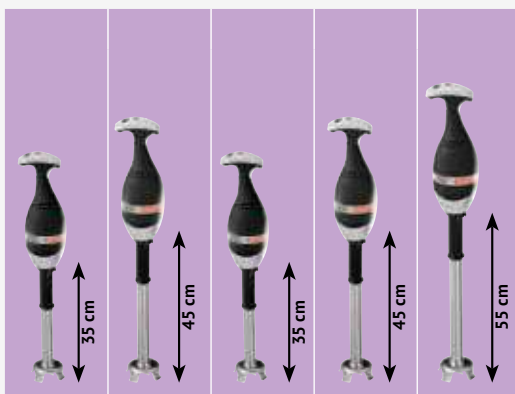

BERMIXER PRO Turbo *10,000 rpm*

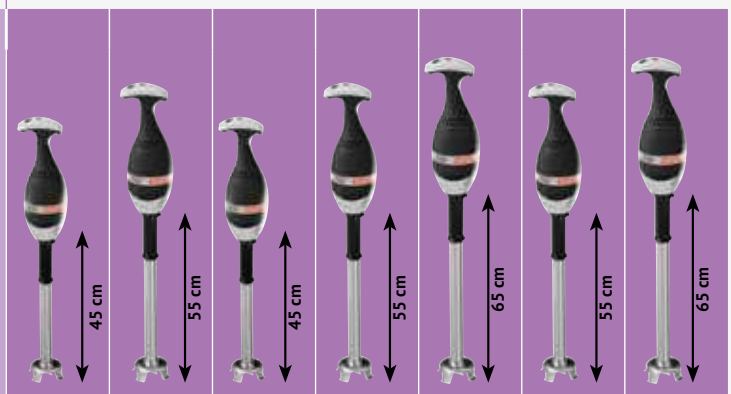

Models	DBP3535	DBP3545	DBP4535	DBP4545	DBP4555	DBP5545	DBP5555	DBP6545	DBP6555	DBP6565	DBP7555	DBP7565
Power	350 W		450 W			550 W		650 W			750 W	
Tube	35 cm	45 cm	35 cm	45 cm	55 cm	45 cm	55 cm	45 cm	55 cm	65 cm	55 cm	65 cm
Max. capacity	30 lt	50 lt	80 lt	100 lt	120 lt	150 lt	170 lt	200 lt	220 lt	240 lt	270 lt	290 lt



■ Turbo Liquidisers TBX120/130 - TBM 150

The partner for your catering facilities to mix and emulsify large quantities.

The tube can be removed and disassembled without tools (TBX120/130) in stainless steel: 100% dishwasher safe



Soup tube attachment



TBX130

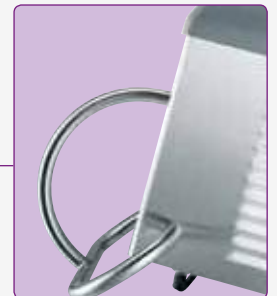

Ergonomic handle

Mounted on a stainless steel trolley for easier movement and storage in the kitchen



- End Users: Catering Facilities
- **From 100 to 500 covers**



- **Main use:** soups, purees, sauces, liquid pastes



- Floor standing mixer mounted on a stainless steel trolley with wheels
- Easily convert from the mixing tube to the puree tube
- **Ergonomic:** comfort and easy to use
- Can be used in braising pans with an optional kit
- Creamy kit available for smoothy preparation (TBX130)
- **Waterproof control panel**
- **Hygiene:** Stainless steel mixing tube can be disassembled without tools and is **100% dishwasher safe** (TBX120/TBX130)
- **Asynchronous industrial motor** for long life and silent operation

**TBM150**

Turbo Liquidisers

Model	Speed	rpm	Power
TBX120	1 speed	1200	900 W
External dimensions (WxDxH) 640x1625x1330mm			

TBX130	1 speed	1600	1500 W
TBX130	2 speeds	850-1700	2200 W
External dimensions (WxDxH) 689x1600x1278mm			

TBM150	1 speed	1600	3000 W
TBM150	2 speeds	830-1660	4500 W
External dimensions (WxDxH) 664x1852x1475mm			

Optional accessories TBX 120 / TBX130



Purée tube



Soup tube



Fish kit



Creamy kit (only for TBX130)



Braising pan kit (only for TBX130)



Purée kit



More than 50 years of experience in the innovation and design of planetary mixers

■ Planetary Mixers

BE5 / BE8

50 years experience in the innovation and design of planetary mixers brought together in a unique and compact model.



- **End Users:** Restaurants/ Catering Facilities / Pastry Making
- **From 10 to 50 covers**



- **Main use:** kneading, emulsifying and whisking



- **5 and 8 lt capacities**
- Powerful asynchronous motor with frequency variator for a precise adjustment of the speed of planetary mechanism **from 20 to 220 rpm**

- Variable speed rotation of the tools from **67 to 740 rpm**
- Tools designed for full coverage of the bowl for uniform mixing of even small quantities
- **100% stainless steel** tools and stainless steel bowl
- **Bowl detection device** which will allow the mixer to switch on only when the bowl is properly positioned with the safety screen*.

* UNI EN 454:2015 Food Processing Machinery - Planetary Mixers - Safety And Hygiene Requirements. This European Standard specifies safety and hygiene requirements for the design and manufacture of fixed bowl planetary mixers with a tool having a planetary movement by using two parallel axes. The capacity of the bowl is greater than or equal to 5 L and less than or equal to 200 L.



Highly resistant splash guard - BPA free

Maximum reliability guaranteed.

- Maximum reliability guaranteed. Transparent screen made from Eastman Tritan™ copolyester* (BPA-free). Impact resistant: stays clear and durable even after hundreds of washes.

* Eastman and Tritan are trademarks of Eastman Chemical Company

- New screwless **clip** system facilitates **easy removal** of the guard for cleaning
- Innovative shape for **easily adding ingredients** during operation



Simple movement of splash guard for fitting and removing the bowl

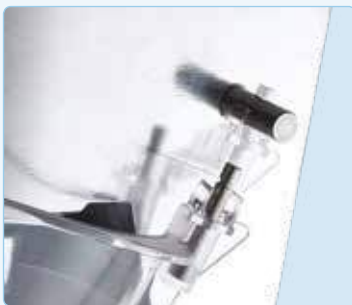

"Clip" system for easy removal



Reinforced splash guard



Ergonomic knob

- Variable speed planetary mechanism adjusted using an ergonomic knob (20–220 rpm)
- Sturdy metal **accessory hub** able to withstand heavy usage
- Optional accessories: meat mincer and pasta kit (for accessory hub models)



Accessory hub (on selected models)



3 tools for 100% performance

- **100% quality**
stainless steel tools
- **100% resistant**
for intensive use and longer life
- **100% hygiene**
dishwasher safe
(tools, bowl and splash guard)



	Hook		Paddle		Whisk	
	Flour*		Potato puree		Whipped egg whites	
	Min.	Max	Min.	Max	Min.	Max
BE5	100 g	1,5 kg	100 g	2 kg	1	10/12
BE8	120 g	2,5 kg	100 g	3,2 kg	1	14/16

* For dough with 60% moisture content



More than 50 years of experience in the innovation and design of planetary mixers

■ Planetary Mixers 10 / 20 lt table top



XBE10



XBM20



- **End Users:** Restaurants/ Catering Facilities / Pastry Making
- From **10 to 100 covers (10 lt)** and from **50 to 150 covers (20 lt)**



- **Main use:** kneading, emulsifying and whisking
- **10 and 20 lt** capacity table top model



- **Bowl detection device** which will allow the mixer to switch on only when the bowl is properly positioned with the safety screen*.

* UNI EN 454:2015 Food Processing Machinery - Planetary Mixers - Safety And Hygiene Requirements. This European Standard specifies safety and hygiene requirements for the design and manufacture of fixed bowl planetary mixers with a tool having a planetary movement by using two parallel axes. The capacity of the bowl is greater than or equal to 5 L and less than or equal to 200 L.



10 lt table top model

- Powerful asynchronous motor for **silent operation** and **longer life**
- Models with electronic or mechanical speed variation from 26 to 180 rpm
- Removable safety screen associated with the raising and lowering of the bowl
- Tool speed rotation: 82 to 570 rpm
- Splash proof planetary system
- Models available with **accessory hub** (type H)
- Stainless steel column
- Capacity (kg flour): **3,5 kg**

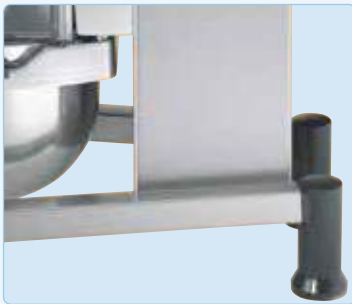

Stainless steel column and feet (10 lt)



Flat and waterproof control panel (IP55) with timer 0-59 minutes



The solid safety screen and the stainless steel wire structure are both removable and disassembled for cleaning and are dishwasher safe (20 lt)



Bowl, hook, paddle, whisk specifically designed for the most efficient result. Mixer starts only when the bowl is in position



20 lt table top model

- Powerful asynchronous motor for **silent operation** and **longer life**
- Models with electronic or mechanical speed variation
- Speed of planetary mechanism: from **30 to 180** rpm (see models)
- Tool speed rotation: 73 to 440 rpm
- Splash proof planetary system
- 10 lt bowl reduction kit available
- Models available with **accessory hub** (type H)
- Capacity (kg flour): **6 kg**
- **Blind/solid safety screen** which will limit flour and unsafe dust particles when used in bakery and pastry preparation.



Removable spout to add ingredient during process



Mechanical versions with 8 speed levels



More than 50 years of experience in the innovation and design of planetary mixers

■ Planetary Mixers 20 / 30 lt freestanding



XBE20



XBM30



- **End Users:** Restaurants/ Catering Facilities / Pastry Making
- From **50 to 150 covers (20 lt)** and from **100 to 300 covers (30 lt)**



- **Main use:** mixing, kneading, emulsifying and whisking



- **Bowl detection device** which will allow the mixer to switch on only when the bowl is properly positioned with the safety screen*.

* UNI EN 454:2015 Food Processing Machinery - Planetary Mixers - Safety And Hygiene Requirements. This European Standard specifies safety and hygiene requirements for the design and manufacture of fixed bowl planetary mixers with a tool having a planetary movement by using two parallel axes. The capacity of the bowl is greater than or equal to 5 L and less than or equal to 200 L.



20 Lt freestanding models

- Powerful asynchronous motor for **silent operation** and **longer life**
- Models with electronic or mechanical speed variation
- Speed of planetary mechanism: from **30 to 180 rpm** (see models)
- Tool speed rotation: 85 to 440 rpm
- Splash proof planetary system
- Models available with **accessory hub** (type H)
- 10 Lt bowl reduction kit available
- Optional wheel kit
- Capacity (kg flour): **6 kg**
- **Blind/solid safety screen** which will limit flour and unsafe dust particles when used in bakery and pastry preparation.



The solid safety screen and the stainless steel wire structure are both removable and disassembled for cleaning and are dishwasher safe (20, 30 lt)



Bowl, hook, paddle, whisk specifically designed for the most efficient result. Mixer starts only when the bowl is in position



Flat and waterproof control panel (IP55) with timer 0-59 minutes

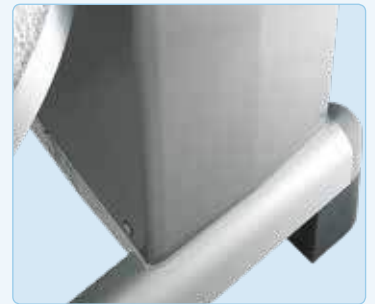

Stainless steel column and feet (on request)



30 Lt freestanding models

- Powerful asynchronous motor for **silent operation** and **longer life**
- Models with electronic or mechanical speed variation
- Speed of planetary mechanism: from **30 to 180 rpm** (see models)
- Tool speed rotation: 73 to 440 rpm
- Splash proof planetary system
- Models available with **accessory hub** (type H)
- 20 Lt bowl reduction kit available
- Optional wheel kit
- Capacity (kg flour): **7 kg**
- **Blind/solid safety screen** which will limit flour and unsafe dust particles when used in bakery and pastry preparation.





More than 50 years of experience in the innovation and design of planetary mixers

■ Planetary Mixers 40 / 60 / 80 lt freestanding



MBE40

BMX60AS

BMXE80



- **End Users:** Restaurants / Catering Facilities Central kitchens / Bakery and Pastry

- From **100 to 400 covers (40 lt)**, from **400 to 800 covers (60/80 lt)**



- **Main use:** mixing, kneading, emulsifying and whisking



- **Bowl detection device** which will allow the mixer to switch on only when the bowl is properly positioned with the safety screen*.

* UNI EN 454:2015 Food Processing Machinery - Planetary Mixers - Safety And Hygiene Requirements. This European Standard specifies safety and hygiene requirements for the design and manufacture of fixed bowl planetary mixers with a tool having a planetary movement by using two parallel axes. The capacity of the bowl is greater than or equal to 5 L and less than or equal to 200 L.



40 lt freestanding models

- Powerful asynchronous motor for **silent operation** and **longer life**
- Electronic variable speed and 3 fixed speeds (see models)
- Flat waterproof control panel equipped with timer
- Speed of planetary mechanism: from **30 to 175 rpm** (see models)
- Tool speed rotation: from 94 to 540 rpm (see models)
- Splash proof planetary system
- Models available with **accessory hub** (type H)
- 20 lt bowl reduction kit available
- Optional wheel kit
- Capacity (kg flour): **10 kg**
- **Blind/solid safety screen** which will limit flour and unsafe dust particles when used in bakery and pastry preparation.



The solid safety screen and the stainless steel wire structure are both removable and disassembled for cleaning and are dishwasher safe (40 lt)



Bowl, hook, paddle, whisk specifically designed for the most efficient result. Mixer starts only when the bowl is in position



Bowl scraper



Feet and column reinforced for heavy duty. Stainless steel frame (on selected models)



60 and 80 lt freestanding models

- **60 and 80 lt** capacity
- Powerful asynchronous motor for **silent operation** and **longer life**
- Models with **mechanical, electrical or electronic speed variation**
- Speed of planetary mechanism: from **20 to 180 rpm**
- Tool speed rotation: 62 to 560 rpm
- Splash proof planetary system
- Motorized bowl movement (on specific models)
- Models available with **accessory hub** (type H)
- **40 or 60 lt** bowl reduction kit available
- Bowl trolley with wheels and bumper facilitates bowl movement (standard on 80 lt)
- Capacity (kg flour): **20 kg** (60 lt) / **25 kg** (80 lt)
- **Blind/solid safety screen** which will limit flour and unsafe dust particles when used in bakery and pastry preparation.



Bowl lighting



More than 50 years of experience in the innovation and design of planetary mixers

Bakery, Pastry and Pizza

Planetary mixers designed for intensive and professional bakery, pastry and pizza applications, with dedicated models 20, 30 and 40 lt capacities.

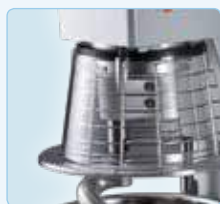

The solid safety screen and the stainless steel wire structure are both removable and disassembled for cleaning and are dishwasher safe (20, 30, 40 lt)



Bowl, hook, paddle, whisk specifically designed for the most efficient result. Mixer starts only when the bowl is in position



MBE40



Control panel with timer, electronic variable speed and 3 fixed speeds



Feet and column reinforced for heavy duty



- **End Users:** Bakery / Pastry / Pizza preparations



- **Bowl detection device** which will allow the mixer to switch on only when the bowl is properly positioned with the safety screen*.



- **Main use:** kneading, mixing, whipping and emulsifying

* UNI EN 454:2015 Food Processing Machinery - Planetary Mixers - Safety And Hygiene Requirements. This European Standard specifies safety and hygiene requirements for the design and manufacture of fixed bowl planetary mixers with a tool having a planetary movement by using two parallel axes. The capacity of the bowl is greater than or equal to 5 L and less than or equal to 200 L.



20 and 30 lt models

- Powerful asynchronous motor (1500 W) for **silent operation** and **longer life**
- Speeds: **3 fixed speeds (40, 80, 160 rpm)** and electronic variable speed from 30 to 175 rpm
- Tools speed: from 73 to 425 rpm
- Reinforced structure and transmission
- Splash proof planetary system
- Control panel equipped with 0-59 minute timer
- Stainless steel **removable** rotating **safety screen**, equipped with removable spout
- Lever for raising and lowering the bowl
- Wheel kit and bowl trolley (optional)



XBB30



Bowl scraper



Bowl trolley

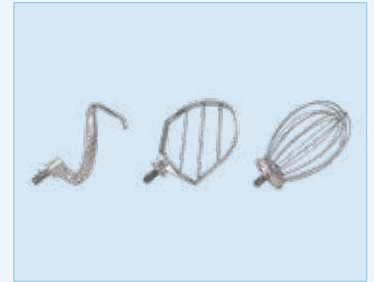

Spiral hook, paddle and reinforced whisk



40 lt models

- Powerful asynchronous motor (2200 W) for **silent operation** and **longer life**
- MB40: 3 fixed speeds (40, 80, 160 rpm)
- MBE40: 3 fixed speeds (40, 80, 160 rpm) and electronic variable speed (30 to 175 rpm)
- Tools speed: 125, 250 and 500 rpm (MB40), from 94 to 540 rpm (MBE40)
- Reinforced structure and transmission
- **20 lt** bowl reduction kit available
- Splash proof planetary system
- Bowl trolley (optional)
- **Blind/solid safety screen** which will limit flour and unsafe dust particles when used in bakery and pastry preparation.





More than 50 years of experience in the innovation and design of planetary mixers

Planetary Mixers make the right choice

Kitchen equipment - electronic variation

								
model	BE5	BE8	XBE10	XBE20	XBE30	MBE40	XBE60	XBE80
capacity	5 lt	8 lt	10 lt	20 lt	30 lt	40 lt	60 lt	80 lt
hook*	1,5 kg	2,5 kg	3,5 kg	6 kg	7 kg	10 kg	20 kg	25 kg
whisk*	10	14	18	32	50	70	100	120

Models also available with mechanical speed variation

Bakery, pastry and pizza

								
model	BE5	BE8	XBB20	XBB30	MB40	MBE40	XBE60	XBE80
capacity	5 lt	8 lt	20 lt	30 lt	40 lt	40 lt	60 lt	80 lt
hook*	1,5 kg	2,5 kg	7 kg	8 kg	10 kg	10 kg	20 kg	25 kg
whisk*	10	14	32	50	70	70	100	120

*Hook: kg of flour for dough (with 60% moisture content)

*Whisk: max. number of egg whites

Accessories ■ Planetary Mixers

Choose the perfect accessory for your preparation



Vegetable slicer



Meat mincer



Puree strainer

**Meat mincer for attachment hub type H.
Simply choose the external support and combine it
with any of the mincing kits for maximum flexibility**



MMH70

653720
External support in
aluminum 70 mm.
Delivered with tray
and pusher



653721
Enterprise aluminum
(knife & discs in s/s)



653722
Enterprise all in s/s



653723
½ Unger all in s/s



MMH82
(recommended for
>40 lt planetary mixers)

653724
External support in
aluminum 82 mm.
Delivered with tray
and pusher



653726
Enterprise aluminum
(knife & discs in s/s)



653725
Enterprise all in s/s



653727
½ Unger all in s/s

■ Vegetable Peelers T Series

Multi-purpose machines. The ideal solutions for peeling, washing, cleaning and drying vegetables and shellfish.



Transparent lid with removable spray gun



Removable bowl for easy unloading and cleaning



T5E/T8E
table top



Integrated filter (depending on model)



Drying basket (optional)



- **End Users:** Restaurants / Catering Facilities



- **Main use:** vegetable peeling and seashell cleaning



- **5 kg or 8 kg** capacity per operation
- Maximum output: **80 kg/h** (T5E) and **130 kg/h** (T8E)

- Removable rotating plate covered with an abrasive material that guarantees **durability** and **longer life**
- Plate speed rotation: **300 rpm**
- Specific models available for **cleaning shellfish** (T5M/T8M) with a reduced speed (208 rpm), seashell plate and cylinder
- **Asynchronous industrial motor** for long life and silent operation



Vegetable Peelers T Series



Transparent and removable lid



Ergonomic handle



T5S



Timer



Knife plate (optional)



- **End Users:** Restaurants / Catering Facilities
- From **30 to 100 covers**



- **Main use:** vegetable peeling



- **5 kg** capacity per operation
- Maximum output: **80 kg/h**
- **Stainless steel construction**

- Removable rotating plate covered with an abrasive material that guarantees **durability** and **longer life**
- Plate speed rotation: **350 rpm**
- **Knife plate** (for a smooth cut of the peel), **washing plate** (for cleaning vegetables that don't require peeling) and stainless steel **filter table** available upon request
- **Safety:** the motor stops if the lid or door is opened during operation
- **Asynchronous industrial motor** for long life and silent operation



■ Vegetable Peelers T Series



Abrasive plate and cylinder



Knife plate



Flat and waterproof control panel with programmable timer (IP55)



Large opening for easy unloading

T10E/T15E



- **End Users:** Restaurants / Catering Facilities / Caterers
- From **50 to 300 covers**



- **Main use:** Vegetable peeling, scrubbing, washing and spinning



- **T10E:** 10 kg capacity per operation
Maximum output: **160 kg/hr**
- **T15E:** 15 kg capacity per operation
Maximum output: **240 kg/hr**

- Stainless steel construction
- Plate speed rotation: **300 rpm**
- Removable rotating plate covered with an abrasive material that guarantees **durability** and **longer life**
- More flexibility with optional plates (knife plate, onion plates, garlic/shallot plate, mussel cleaner, brushing plate and drying basket)
- **Safety:** the motor stops if the lid or door is opened during operation
- **Asynchronous industrial motor** for long life and silent operation

T25



- End Users: Restaurants / Central Kitchens / Catering Facilities / Caterers
- **From 100 to 500 covers**



- **Main use:** peeling all types of hard skinned vegetables (celery, potatoes, carrots)



- **25 kg** capacity per operation
- Maximum output: more than **400 kg/h**
- Plate speed rotation: **300 rpm**
- The cylinder and removable rotating plate are covered with an abrasive material that guarantees **durability** and **longer life**
- Stainless steel construction
- Door with constant pressure control system for the **safe unloading** of the **vegetables**
- **Safety:** the motor stops if the lid or door is opened during operation
- Flat and **waterproof** control **panel** (IP55)
- **Asynchronous industrial motor** for long life and silent operation



T25E

Possibility to choose the direction of the evacuation of peelings



Ti25

Integrated filter basket as standard



Drain hole



Unloading door

T series peelers

Model	Capacity	Dimensions (WxDxH)	Notes
T5S	5 kg	314x485x450 mm	
T5E/T5M	5 kg	424x390x590 mm	special model for seashells
T8E/T8M	8 kg	422x396x676 mm	special model for seashells
T10E	10 kg	440x690x680 mm	
T15E	15 kg	440x690x750 mm	
T25E	25 kg	585x785x1215 mm	
Ti25	25 kg	565x880x1425 mm	inclined body

■ Vegetable Washers and Spin Dryers

A great choice for all kitchen sizes.



LVA100



- **End Users:** Restaurants / Catering facilities
- Up to 200 covers



- **Main use:** Washing and drying vegetables (e.g. green salads, spinach, leeks, etc.)



- **30 lt** bowl capacity for **2 to 6 kg** of vegetables
- The washing effect is obtained by combining basket rotation and water turbulence generated by a pump
- 3 preset cycles according to the type of

products to be washed

- Basket with 2 speed rotation: washing (60 rpm), drying (270 rpm)
- **Asynchronous industrial motor** for long life and silent operation
- Integrated dispenser with liquid for sanitizing vegetables (in specific cycle)
- Spray and/or immersion washing, depending on cycle
- **Avoid damage to delicate** items by regulating the power of the washing water
- **Operator safety** thanks to microswitch which stops the machine if the lid is opened



- **End Users:** Restaurants / Catering Facilities
- **From 100 to 300 covers**



- **Main use:** Spinning of all vegetables and herbs, lettuce, spinach, parsley, leeks



- For spinning **4/5 kg of vegetables** or **5/6 kg of green salads**
- Two cycles for all types of vegetables: “automatic” which alternates rotation (450 rpm) with several sudden stops; “manual” thanks to the adjustable timer 0-59 min
- **Asynchronous industrial motor** for long life and silent operation
- **Safety:** the motor stops when the lid is opened
- Flat and waterproof control panel (IP55)

Model	Capacity		Basket volume	Power
	Heavy veg.	Lettuce heads		
EL40	5 kg	9	32 lt	370 W

External dimensions (WxDxH) 460x540x800mm

**EL40**

- **End Users:** Restaurants / Catering Facilities / Central Kitchens
- **From 200 to 500 covers**



- **Main use:** Spinning of all vegetables and herbs, lettuce, spinach, parsley, leeks



- For spinning in **2 minutes 10 kg of vegetables** or **10/15 kg of green salads** (330 rpm)
- **Asynchronous industrial motor** for long life and silent operation
- **Safety:** the motor stops when the lid is opened
- Flat and waterproof control panel (IP55)
- **Stainless steel or resin baskets as option**

Model	Capacity		Basket volume	Power
	Heavy veg.	Lettuce heads		
ELX65	10 kg	18	65 lt	750 W

External dimensions (WxDxH) 578x639x1005mm

**ELX65**

Flat and waterproof control panel (IP55)



Stainless steel/aluminum drying basket



Residual water drain

Complementary products for your kitchen:

A bread slicer, dough kneaders and dough sheeters

PRECISION

Blade specifically designed to avoid crushing the bread



Patented safety device prohibits access to the blade



Separator to cut 2 baguettes at the same time



Flat and waterproof control panel



- **End Users:** Restaurants / Catering facilities / Canteens
- **From 50 to 500 covers**



- Versatile and easy to use single chute electric bread slicer
- Optimum result: **adjustable slice thickness from 8 to 60mm**
- Patented safety device **prohibits access to the blade** during cleaning operations
- **Asynchronous industrial motor** for long life and silent operation



- End Users: Restaurants / Catering Facilities / Bakery / Pizzerias
- **From 3 to 24 kg** of dough per operation (depending on model)



- **Fork kneaders with 25 or 40 lt capacity**
- Motor with **2 speeds** for optimum kneading (45 rpm and 90 rpm)
- Flat and waterproof control panel with timer (0-59 min)
- **Transparent screen to avoid the emission of flour into the work area**
- **Removable stainless steel bowl** with presence sensor
- **Asynchronous industrial motor** for long life and silent operation



BPO



- **End Users:** Pizzerias / Bakery
- **From 10 to 40 kg** of dough per operation (depending on models)



- 1 speed spiral dough kneaders with **12 to 49 lt bowl capacity**
- **Transparent screen to avoid the emission of flour into the work area** (on selected models)
- Rounded bottom **stainless steel bowl** facilitates cleaning
- Stainless steel mixing arm
- **Larger models** equipped with central shaft (38, 49 lt)
- **Asynchronous industrial motor** for long life and silent operation



ZSP



- **End Users:** Catering Facilities / Bakery / Pizzerias
- **Up to 48 kg** of dough per operation



- Spiral dough kneaders with **50 and 90 lt bowl capacity**
- **Two speed** kneading motor with manual speed variation
- Protective screen **to avoid the emission of flour into the work area**
- Rounded bottom **stainless steel bowl** facilitates cleaning
- Stainless steel mixing arm
- **Asynchronous industrial motor** for long life and silent operation



PSR100



■ Dough Sheeters

Allows the working of all types of lining pastry and dough.



- **End Users:** Restaurants / Catering Facilities / Small Kitchens and Bakeries



- Manual dough sheeter - table top model
- Compact and easy to move
- Cylinders are **teflon coated** (Ø 60 mm)
- Working width: **400 mm**. Dough thickness: **0,1 to 28 mm**
- Removable stainless steel slides / flaps

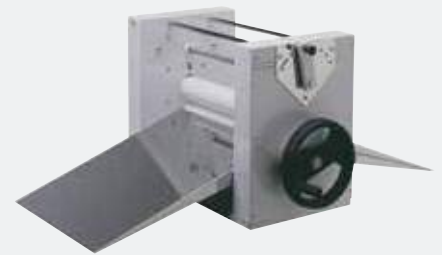

LMP400



- **End Users:** Restaurants / Catering Facilities / Small Kitchens
- Up to 300 settings



- Motorized dough sheeter - table top model
- **Wire safety screen**
- **Teflon coated** removable flaps facilitate the sliding of the dough
- Chrome plated steel cylinders (Ø 60 mm) may be adjusted depending on the thickness requested. Thickness **0,1 to 34 mm**
- Working width: **500 mm**
- Manual lever to invert cylinder rotation
- Flour container fixed on the top of the machine
- Remote foot pedal to change rolling direction (optional accessory)
- Optional trolley available
- **Asynchronous industrial motor** for long life and silent operation



LMP500

**LMP500BT**

- **End Users:** Large Catering Facilities / Small Central Kitchens
- **Up to 1000 settings**



- Motorized belt dough sheeters - table top and floor standing models
- Models with **1 speed** or **variable speed**
- Tables can be raised to **save space**
- **Wire gratings** with safety microswitch to stop motor if raised over a particular level
- **Teflon coated** removable slides facilitate the sliding of the dough
- Chrome plated steel cylinders (Ø 60 mm) may be adjusted depending on the thickness requested
- Manual lever to invert cylinder rotation
- Working widths: **500 mm** or **600 mm** (depending on model)
- Flour container fixed on the top of the machine
- Remote foot pedal to change rolling direction (optional accessory)
- **Asynchronous industrial motor** for long life and silent operation



Remote foot pedal (optional)

Cutting module for croissants
(optional
on selected models)**LMP600BT**



■ Food slicers

An extensive range of food slicers which provide a rational solution for any kind of customers: restaurants, catering, supermarkets and delis.



Plexiglass safety hand guard as standard



IP42 water protection for operator safety

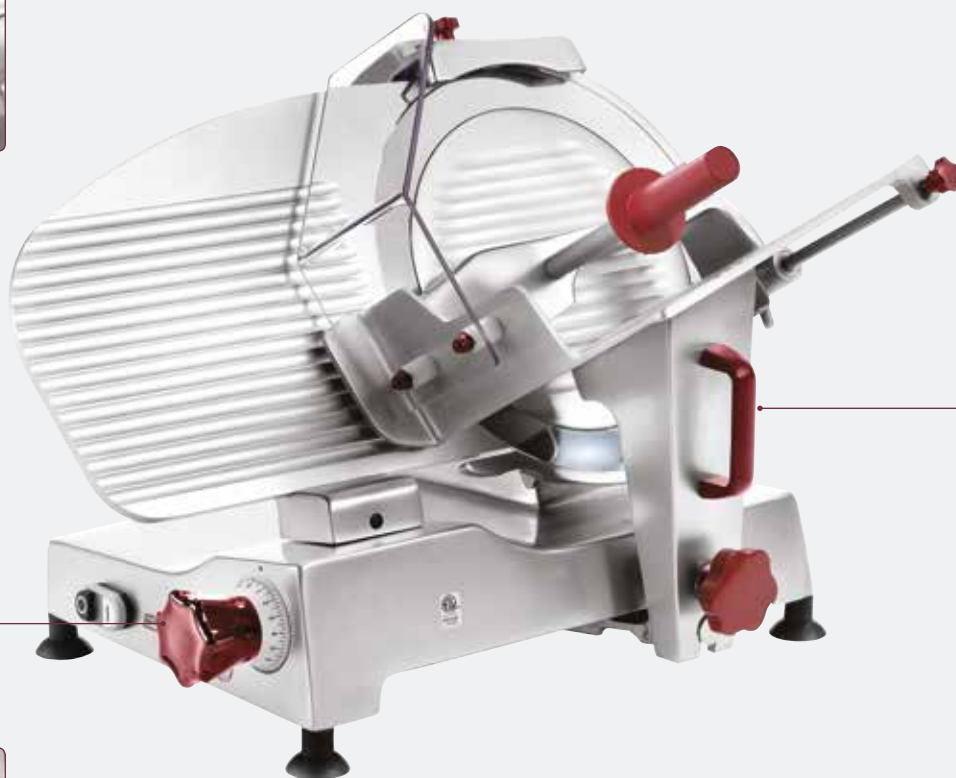

Cut thickness-adjusting knob (millimeter adjustment)



Made in high polished satin finished anodized aluminium



- **End Users:** Restaurants / Hotels / Small catering facilities / Retail / Supermarkets / Delies



- **DMSL25B:** Light duty gravity slicer 250mm, belt transmission
- **DMSG30B:** 300 mm Gravity Slicer, belt transmission
- **DMSG35B:** Vertical slicer 300mm, belt transmission
- **DMSG35B:** Gravity slicer 350mm, gear transmission



- Highest degree of safety in functioning, cleaning and maintenance
- Made in polished satin finished anodized aluminium for high hygiene of parts interested by the cut, good resistance to acids and salts and oxidation
- Blades made of chrome forged steel
- Thickness adjusting knob: 1 mm steps adjustments
- Top-mounted stone blade sharpener and easy-to-remove blade cover
- Optional accessory blades available
- **Belt driven manual slicers:** with Poly-V belt drive system for silent operations and economical service
- **Gear transmission manual slicer:** for heavy duty use



DMSL25B



DMSG30B



DMSG35B



DMSG35G

Food slicers

Cutting capacity	square	rectangular	round	
DMSL25B	250 mm	170x170 mm	220x145 mm	Ø 180 mm
DMSG30B	300 mm	190x190 mm	250x190 mm	Ø 220 mm
DMSG35B	300 mm	220x220 mm	230x220 mm	Ø 220 mm
DMSG35G	350 mm	210x210 mm	300x210 mm	Ø 240 mm



■ Meat mincers

Mince a variety of meats for hamburgers, sausages, meat balls.



304 AISI stainless steel body and mincing unit



Stainless steel roller and collection container included as standard



Output mouth 70 mm or 82 mm



Stainless steel mincing unit, dishwasher safe



- **End Users:** Restaurants / hotels / small catering facilities / retail / supermarkets



- **DMM12UHX: Meat mincer with 1/2 Unger stainless steel mincing unit, output mouth Ø 70mm**
- **Attachment type 12**
- **200 rpm** screw revolutions
- **Productivity: 200-250 Kg/h**

**DMM12UHX**

- **End Users:** Restaurants / hotels / small catering facilities / retail / supermarkets



- **DMM22UX3: Meat mincer with full Unger stainless steel mincing unit, output mouth Ø 82 mm**
- **Attachment type 22**
- **140 rpm** screw revolutions
- **Productivity: 350-400 Kg/h**

**DMM22UX3**

- Robust stainless steel body
- Faster processing thanks to Unger mincing system
- Mincing unit in stainless steel, easy to remove and to clean, dishwasher safe
- Supplied with standard plates:
1/2 Unger: Ø 0 mm + 6mm + 1 knife
Full Unger: Ø 0 mm + 10 mm + 6mm + 2 knives
- Ventilated motor, with thermal protection
- Stainless steel roller and collection container included as standard



■ Vacuum packers

Range of appliances for vacuum packing of cooked and raw foods, ideal for storage and sous-vide cooking, ensuring highest levels of hygiene.

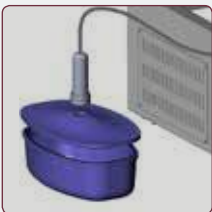

External vacuum program – lid open, sealing bar not active



Valve for connecting an adaptor kit for external vacuum



Domed transparent Plexiglass lid



Built-in printer (only 600528)



- **End Users:** Restaurants/ hotels / small catering facilities /retail / supermarkets



- **DVP45: Table-top vacuum packer 20 m³/h**
- Sealing bar 450 mm
- Digital control panel allows programming and storing of up to 9 operating programs
- **DVP302: Table-top vacuum packer 8 m³/h**
- Sealing bar 310 mm
- Digital control panel allows the selection of up to 10 operating programs

- **DVP31A: Table-top vacuum packer 10 m³/h**
- Sealing bar 310 mm
- Digital control panel allows the selection of up to 10 operating programs
- **DVP302NXT: Table-top vacuum packer 8 m³/h with printer**
- Sealing bar 310 mm
- Digital control panel allows the selection of up to 10 operating programs
- Delivered with printer



- Up to 10 customizable programs and external vacuum possible
- 304 AISI stainless steel construction
- All models with high quality Busch vacuum pumps, acid-resistant
- Double sealing of bags for higher safety
- Easy to remove sealing bar (no cables), with overheat protection
- Robust PE-HD shelves inside for optimal filling ergonomomy
- Sturdy, transparent plexiglass lid for full control during operations
- Automatic detection of electronic malfunctions, toner ink and oil levels and vacuum packing process
- Model with built-in printer available



DVP302



DVP302NXT



DVP31A



DVP45

ETABLISSEMENT AUBUSSON
Z.I du Mont - 23200 AUBUSSON - FRANCE
Tel: +33 (0)5 55 83 23 23 - Fax: +33 (0)5 55 83 23 40

Website: www.ditosama.com

HEAD OFFICE: ELECTROLUX PROFESSIONNEL SAS
43 avenue Félix Louat - 60300 SENLIS - FRANCE



*Visit our website
for inspiration*

