

distform

foodservice solutions

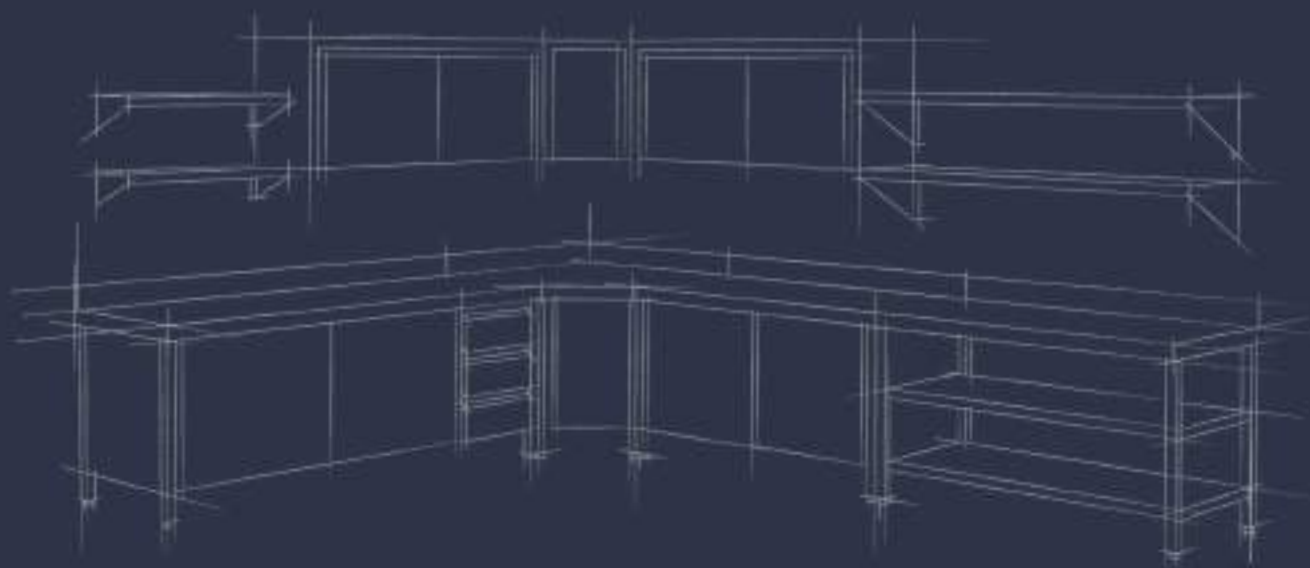

General Catalogue March 2018

NEW FACILITIES FOCUSED ON INDUSTRY 4.0

Distform is a sector-leading Spanish manufacturer. We have spent years perfecting our products and striving to offer excellent solutions that have impeccable designs and features. Founded in 1991, Distform has always been a pioneering business in the field of static preparation and self-services, with a wide range of high-quality, eco-friendly products.



The construction of a new factory and office space, which will occupy 12,000 m², are part of the new company expansion plan. These new facilities feature the most modern management technologies, focused on Industry 4.0. This allows for reduced fabrication times and further raise the quality and traceability of the products that are made, making it one of the most advanced facilities in its sector.

ONGOING INVESTMENT IN THE LATEST TECHNOLOGIES

The design and development of our products is based on meticulous studies with the clear goal of satisfying the needs of our clients, providing solutions that increase functionality, efficiency, durability, and reliability.



Every detail is important. That's why we continue to place special emphasis on every aspect of our products in order to ensure that they are the best they can be, just as we always have. Committed to this goal, we work with leading R&D professionals and the most up-to-date technology.



EXCELLENCE IN SERVICE, PRODUCT, AND DELIVERY

Proven experience in the processes of creation, development, and fabrication are the pillars upon which the high efficiency, quality, and reliability of our products are based. The best solution on the market.



24-HOURS PRODUCTION TIME

80% of our products have a 24 hour shipping time thanks to our automated production system, high level of efficiency and large stock of products



CUSTOMIZABLE LENGTH

One new feature in the Distform 2018 catalogue is customizable length for tables, countertops, wash tables, and shelving units.

MORE THAN 7,000 ACTIVE REFERENCES

By constantly improving our manufacturing processes, investing in R&D, and building relationships with our clients, we are able to offer 7,000 high-quality active references that are easy to assemble and install. These features make us the most trusted brand for our customers.

UNIFORM DESIGN

Two ranges of combinable products, with uniform design and an infinite number of models and accessories: simply imagine what you need and we will make your vision a reality.

- Table/Industrial Sink Line
- Modular furniture line

NEW DISTFORM DESIGNS

We are pleased to present our new Distform Catalogue, full of important new features. Among them are two design lines: Tables/Industrial sinks and modular furniture.

Table/Industrial Sink Line

A wide range of products that offer infinite possibilities from functional and uniform lines of products with a minimalist style for clients who want to create a facility with high-quality, durable finishes at a competitive price. For these lines, buyers can also customize the length of the units they purchase.

This line is comprised of industrial sinks and tables which include doors, drawers, and shelves. Enjoy the impeccable design of the tables, which come equipped with a highly durable and elegant countertop surface. All of these products have 24-hours production time thanks to automation and permanent stock.

EXAMPLES OF COMBINATIONS P. 12 AND P. 42



Modular Furniture Line

The new line of modular furniture was created for customers who are looking for the highest quality fixtures on the market. It offers a wide range of modules and countertops. The modular design is the best solution for optimizing the space, as it can be adapted to any kind of kitchen or facility. Thanks to the wide range of existing products and the

option of customizing the length of these modules, we can provide clients with solutions tailored to their needs. Also, thanks to the continuous countertop system, we can provide greater hygiene and cleanliness.

Distform modular furniture is synonymous with design, sturdiness, and high-quality with the fastest possible service.

EXAMPLES OF COMBINATIONS P. 82 AND P. 101



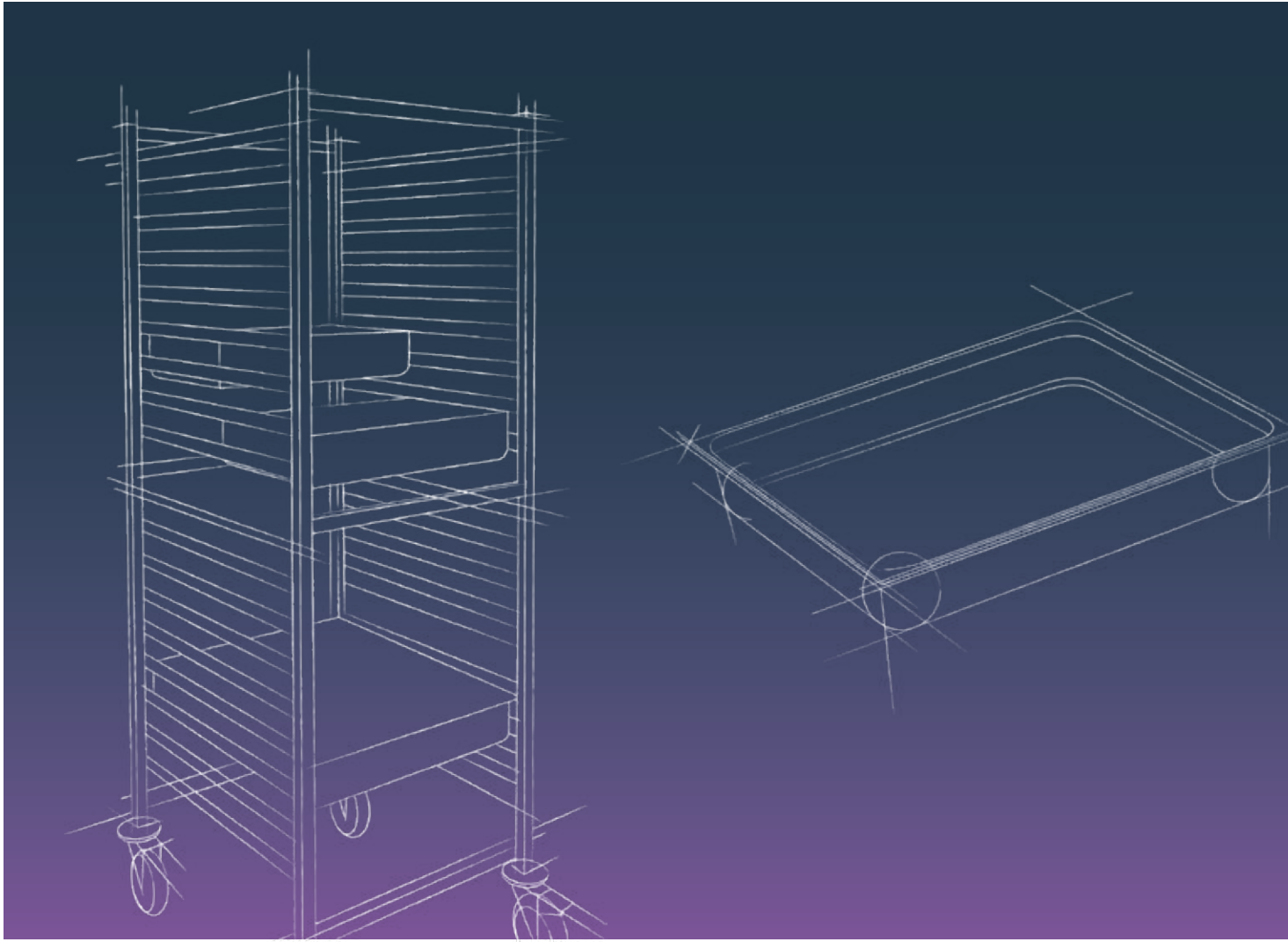
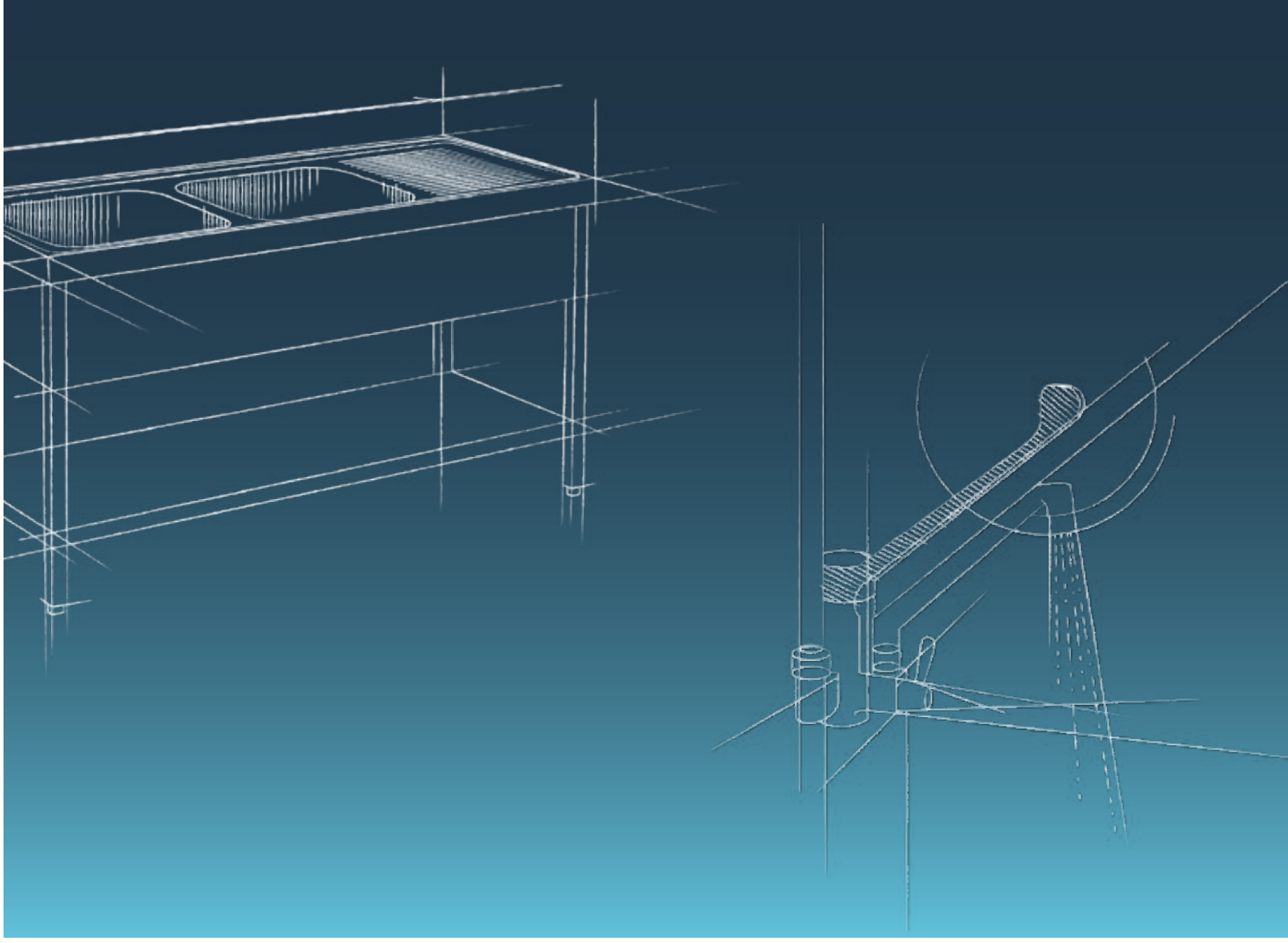

STATIC PREPARATION

Industrial sinks, hand sinks, and washing areas	P. 12
Taps	P. 32
Work tables	P. 40
Hot food and bain-marie tables	P. 74
Modules and countertops for cooking	P. 80
Cabinets	P. 102
Shelving	P. 108

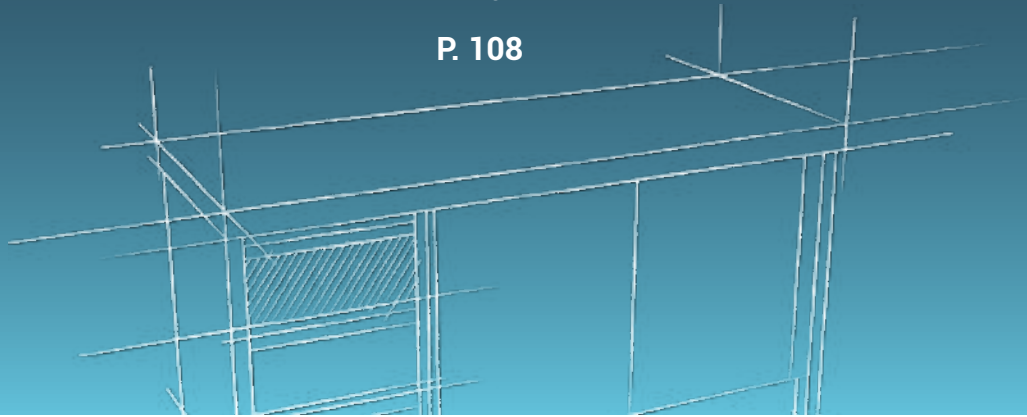

FOOD DISTRIBUTION AND DISPLAY

Transport trolleys	P. 135
Temperature maintenance trolleys and Bain-marie trolleys	P. 145
Regeneration ovens	P. 153
Gastronorm containers	P. 159
Drop-in	P. 165
Self-Service	P. 181

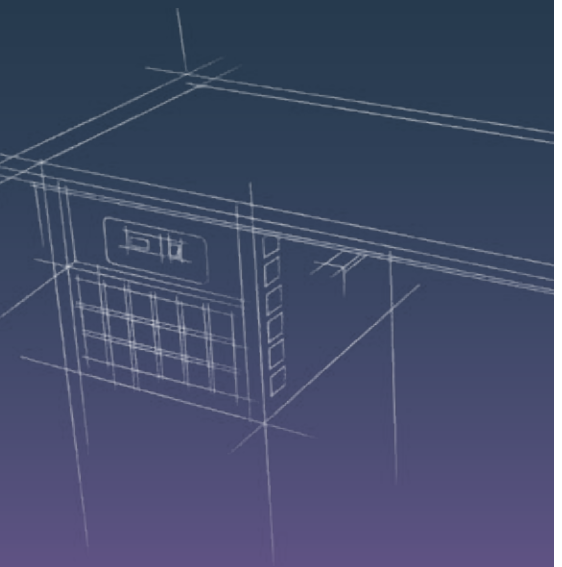

STATIC PREPARATION

Industrial sinks, hand sinks, and washing areas

Pages 12–31

Taps

Pages 32–39

Work tables

Pages 40–73

Hot food and bain-marie tables

Pages 74–79

Modules and countertops for cooking

Pages 80–101

Cabinets

Pages 102–107

Shelving

Pages 108–131



distform

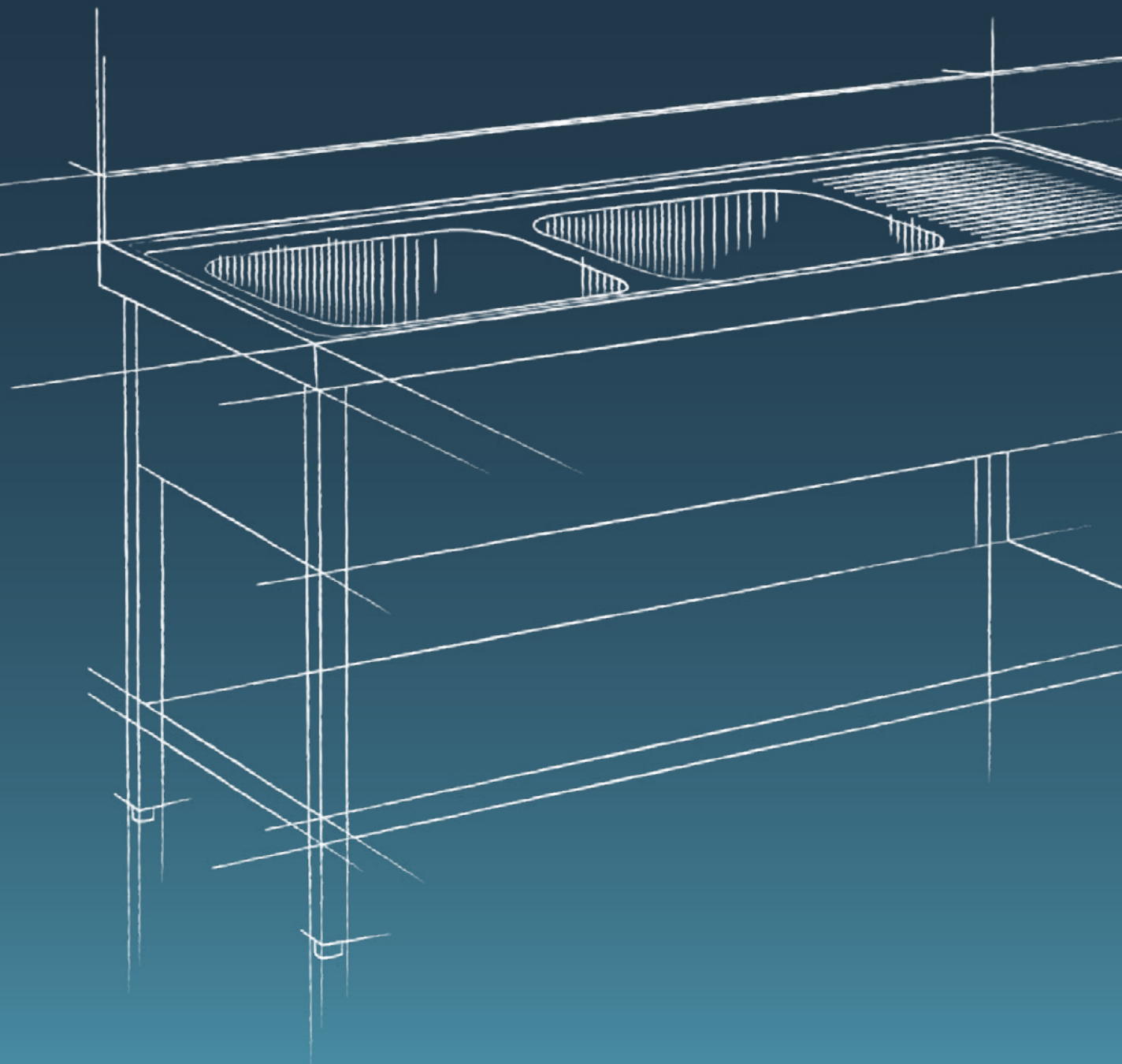

A technical drawing of a sink assembly, showing a top-down view of the sink basin and a side view of the drain and faucet area. The drawing is composed of white lines on a dark blue background.

INDUSTRIAL SINKS, HAND SINKS, AND WASHING AREAS

Industrial sinks	P. 14
Food preparation	P. 24
Industrial sink accessories	P. 25
Hand sinks	P. 26
Washing areas	P. 28

**UNIFORM, FUNCTIONAL
LINES WITH HIGH-
QUALITY FINISHES AND
COMPETITIVE PRICES**

Countertops and
industrial sinks made
of AISI 304 stainless
steel 18/10 with
perfect finishes



**A WIDE RANGE OF
INDUSTRIAL SINKS AND
ACCESSORIES WITH
IMMEDIATE DELIVERY
PERIODS**

Adjustable legs can
be raised as high as
900 mm



Industrial sinks with inlaid basins and sound-proof protection



105 mm high backsplash with rounded safety edges, fully welded, for wall units



65 mm fully-welded front cover with rounded safety edges.



NEW

**Uniform design.
Versatile with work
tables and other
Distform products.**

**Combine them
however you want!**

INDUSTRIAL SINKS

Semi-professional 500 Series

NEW

Industrial sink

- Made entirely of AISI grade 304 stainless steel (18/10).
- Basins inlaid with sound-proofing protection.
- Drainage valve and plug included in each basin.
- Backsplash and 30 mm front cover.
- 340 mm x 365 mm x 150 mm basin.

Frame

- Frames made entirely of stainless steel.
- Structure with fully welded tubes.
- 30 x 30 mm square stainless steel legs are extendable, allowing you to raise the height of the unit from 850 to 880 mm.
- Designed to include a glass washer.
- **No assembly required.**



Industrial sink with frame and doors

- Made of AISI grade 304 stainless steel (18/10).
- Backsplash and 30 mm front cover.
- Structure with fully welded tubes.
- 30 x 30 mm square stainless steel legs allow you to raise the height of the unit from 850 to 880 mm.
- Available with hinged or sliding doors depending on the model.
- Open rear section to facilitate access to installations.
- **No assembly required.**
- **Optional door latches OPC00001**



Total dimensions (mm)	Industrial sink	Industrial sink with frame	Industrial sink with frame and shelf	Industrial sink with frame and doors
800 x 500	• T085331D	• FBD50080	• FBD15080	• FBPD5080 SW
	• T085331I	• FBI50080	• FBI15080	• FBPI5080 SW
1000 x 500	• T105331D	• FBD50100	• FBD15100	• FBPD5100 SL
	• T105331I	• FBI50100	• FBI15100	• FBPI5100 SL
1200 x 500	• T125332D	• FBD50120	• FBD15120	• FBPD5120 SL
	• T125332I	• FBI50120	• FBI15120	• FBPI5120 SL
1350 x 500	• T135332D	• FBD50135	• FBD15135	• FBPD5135 SL
	• T135332I	• FBI50135	• FBI15135	• FBPI5135 SL

• **SW** - Swinging Doors / **SL** - Sliding Doors

• **24-hour shipping**

Industrial sink with frame, doors, and space for glasswashers

- Made of AISI grade 304 stainless steel (18/10).
- Backsplash and 30 mm front cover.
- Structure with fully welded tubes.
- 30 x 30 mm square stainless steel legs allow you to raise the height of the unit from 850 to 880 mm.
- Swinging doors
- Open rear section to facilitate access to installations.
- **No assembly required.**
- **Optional door latches OPC0001**



Total dimensions (mm)	Industrial sink with frame and doors	Doors
1000 x 500	• FBPLD510	1
	• FBPLI510	1
1350 x 500	• FBPLD513	2
	• FBPLI513	2

Semi-professional 500 Series tables

- Table made entirely of AISI 304 18/10 stainless steel.
- Backsplash and 30 mm front cover.
- Structure with fully welded tubes.
- 30 x 30 mm square stainless steel legs allow you to raise the height of the unit from 850 to 880 mm.
- Usable space between shelves: 1 shelf - 600 mm / 2 shelves - 300 mm.
- Compatible with 500 Series industrial sinks.
- **No assembly required.**



Total dimensions (mm)	Table with reinforcing frame	Table with shelf	Table with two shelves
600 x 500 x 850	• FBM50060	• FBM15060	• FBM25060
800 x 500 x 850	• FBM50080	• FBM15080	• FBM25080
1000 x 500 x 850	• FBM50100	• FBM15100	• FBM25100
1200 x 500 x 850	• FBM50120	• FBM15120	• FBM25120
1400 x 500 x 850	• FBM50140	• FBM15140	• FBM25140
1500 x 500 x 850	• FBM50150	• FBM15150	• FBM25150

Accessories

Glass washer stand

- Made of stainless steel.
- **Fully welded structure.**



Brackets for 500 Series Industrial sinks

- Made of AISI grade 304 stainless steel (18/10).
- Set of 2 brackets (right and left)
- 1.5 mm thick.



Total dimensions (mm)	Code
510 x 510 x 120	• FP000500

Code
• FBCA0001

• 24-hour shipping

INDUSTRIAL SINKS

550 Series

NEW

Industrial sink

- Made entirely of AISI grade 304 stainless steel (18/10).
- Basins inlaid with sound-proofing protection.
- Inlaid drain valve and overflow pipe included in each basin.
- 105 mm backsplash and 65 mm front panel with rounded safety edges, fully welded.
- Taps not included.







 **Taps** page 33

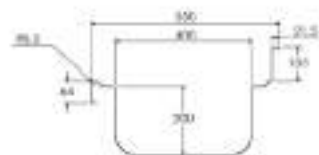

Frame

- Frames made entirely of stainless steel.
- The frame adapts easily to the industrial sink thanks to a simple assembly method.
- This unit's special attachment system allows the industrial sink to fit snugly into the frame, ensuring that there are no gaps.
- 40 x 40 mm square stainless steel legs allow you to raise the height of the unit from 850 to 900 mm.
- Rear legs raised 40 mm to allow you to set the frame on a floor with a sanitary radius.
- Designed to include a lower shelf (optional).
- **Easy assembly in 3 minutes.**
- **Can be shipped fully assembled.**
- Up to 1200 mm: **MF001200**
- Up to 2000 mm: **MF002000**



Total dimensions (mm)	Basin dimensions (mm)	Industrial sink	Industrial sink with frame	Industrial sink with frame and shelf
1000 x 550	 400 x 400 x 200	• L105541D	• FBD05100	• FBDE5100
	 400 x 400 x 200	• L105541I	• FBI05100	• FBIE5100
1200 x 550	 400 x 400 x 200	• L125541D	• FBD05120	• FBDE5120
	 400 x 400 x 200	• L125541I	• FBI05120	• FBIE5120
1400 x 550	 400 x 400 x 200	• L145544D	• FBD05140	• FBDE5140
	 400 x 400 x 200	• L145544I	• FBI05140	• FBIE5140

• **24-hour shipping**

Industrial sink with frame and doors

- Made of AISI grade 304 stainless steel (18/10).
- 105 mm backsplash and 65 mm front panel with rounded safety edges, fully welded.
- 40 x 40 mm square stainless steel legs allow you to raise the height of the unit from 850 to 900 mm.
- Rear legs raised 40 mm to allow you to set the frame on a floor with a sanitary radius.
- Open rear section to facilitate access to installations.
- **No assembly required.**
- **Optional door latches OPC00001**



Total dimensions (mm)	Basin dimensions (mm)	Industrial sink with frame and doors		
1000 x 550		400 x 400 x 200	• FBPD5510	Sliding Doors
		400 x 400 x 200	• FBPI5510	Sliding Doors
1200 x 550		400 x 400 x 200	• FBPD5512	Sliding Doors
		400 x 400 x 200	• FBPI5512	Sliding Doors
1400 x 550		400 x 400 x 200	• FBPD5514	Sliding Doors
		400 x 400 x 200	• FBPI5514	Sliding Doors

Industrial sink with frame and space for dishwasher

- Designed to incorporate a standard glass washer or dishwasher under the dish drying table.
- Inlaid drain valve and overflow pipe included in each basin.
- 40 x 40 mm square stainless steel legs allow you to raise the height of the unit from 850 to 900 mm.
- Rear legs raised 40mm to allow you to set the frame on a floor with a sanitary radius.
- 105 mm backsplash and 65 mm front panel with rounded safety edges, fully welded.
- **Easy assembly in 3 minutes.**
- **Models with doors are shipped pre-assembled.**
- **Can be shipped fully assembled.**
Up to 1200 mm: **MF001200**
Up to 2000 mm: **MF002000**
- **Optional door latches OPC00001**



Total dimensions (mm)	Basin dimensions (mm)	Industrial sink with frame	Industrial sink with frame and shelf	Industrial sink with frame and doors
1200 x 550		• FBD0L512	• FBDEL512	• FBPDL512 SW
		• FBI0L512	• FBIEL512	• FBPIL512 SW
1400 x 550		• FBD0L514	• FBDEL514	• FBPDL514 SW
		• FBI0L514	• FBIEL514	• FBPIL514 SW

- **SW** - Swinging Doors

• **24-hour shipping**

INDUSTRIAL SINKS

600 Series

NEW

Industrial sink

- Made entirely of AISI grade 304 stainless steel (18/10).
- Basins inlaid with sound-proofing protection.
- Inlaid drain valve and overflow pipe included in each basin.
- 105 mm backsplash and 65 mm front panel with rounded safety edges, fully welded.
- Taps not included.









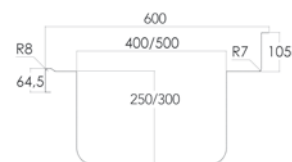











 **Taps** page 33



Frame

- Frames made entirely of stainless steel.
- The frame adapts easily to the industrial sink thanks to a simple assembly method.
- This unit's special attachment system allows the industrial sink to fit snugly into the frame, ensuring that there are no gaps.
- 40 x 40 mm square stainless steel legs allow you to raise the height of the unit from 850 to 900 mm.
- Rear legs raised 40 mm to allow you to set the frame on a floor with a sanitary radius.
- Designed to include a lower shelf (optional).
- **Easy assembly in 3 minutes.**
- **Can be shipped fully assembled.**
- Up to 1200 mm: **MF001200**
- Up to 2000 mm: **MF002000**



Total dimensions (mm)	Basin dimensions (mm)	Industrial sink	Industrial sink with frame	Industrial sink with frame and shelf
600 x 600	 500 x 400 x 250	• L0665410	• FB006060	• FB0E6060
700 x 600	 500 x 500 x 300	• L0765510	• FB006070	• FB0E6070
1000 x 600	 400 x 400 x 250	• L106441D	• FBD06100	• FBDE6100
	 400 x 400 x 250	• L106441I	• FBI06100	• FBIE6100
1200 x 600	 400 x 400 x 250	• L1064420	• FB206100	• FB2E6100
	 500 x 400 x 250	• L126541D	• FBD06120	• FBDE6120
1300 x 600	 500 x 400 x 250	• L126541I	• FBI06120	• FBIE6120
	 500 x 400 x 250	• L1265420	• FB206120	• FB2E6120
1400 x 600	 500 x 400 x 300	• L136551D	• FBD06130	• FBDE6130
	 500 x 400 x 300	• L136551I	• FBI06130	• FBIE6130
1400 x 600	 500 x 500 x 300	• L1365520	• FB206130	• FB2E6130
	 400 x 400 x 250	• L146442D	• FBD06142	• FBDE6142
1400 x 600	 400 x 400 x 250	• L146442I	• FBI06142	• FBIE6142
	 500 x 400 x 250	• L146541D	• FBD06140	• FBDE6140
1600 x 600	 500 x 400 x 250	• L146541I	• FBI06140	• FBIE6140
	 500 x 400 x 250	• L166542D	• FBD06160	• FBDE6160
1600 x 600	 500 x 400 x 250	• L166542I	• FBI06160	• FBIE6160
	 500 x 400 x 300	• L186542D	• FBD06180	• FBDE6180
1800 x 600	 500 x 400 x 300	• L186542I	• FBI06180	• FBIE6180
	 500 x 400 x 250	• L2065420	• FB006200	• FB0E6200

• 24-hour shipping

Industrial sink with frame and doors

- Made of AISI grade 304 stainless steel (18/10).
- 105 mm backsplash and 65 mm front panel with rounded safety edges, fully welded.
- 40 x 40 mm square stainless steel legs allow you to raise the height of the unit from 850 to 900 mm.
- Rear legs raised 40 mm to allow you to set the frame on a floor with a sanitary radius.
- Available with hinged or sliding doors depending on the model.
- Open rear section to facilitate access to installations.
- **No assembly required.**
- **Optional door latches OPC0001**



Total dimensions (mm)	Basin dimensions (mm)	Industrial sink with frame and doors	
600 x 600	500 x 400 x 250	• FBPD6060	Swinging doors
1000 x 600	400 x 400 x 250	• FBPD6100	Sliding Doors
	400 x 400 x 250	• FBPI6100	Sliding Doors
1200 x 600	400 x 400 x 250	• FBPD6100	Sliding Doors
	500 x 400 x 250	• FBPD6120	Sliding Doors
	500 x 400 x 250	• FBPI6120	Sliding Doors
1400 x 600	500 x 400 x 250	• FBPD6120	Sliding Doors
	400 x 400 x 250	• FBPD2614	Sliding Doors
	400 x 400 x 250	• FBPI2614	Sliding Doors
	500 x 400 x 250	• FBPD6140	Sliding Doors
1600 x 600	500 x 400 x 250	• FBPI6140	Sliding Doors
	500 x 400 x 250	• FBPD6160	Sliding Doors
	500 x 400 x 250	• FBPI6160	Sliding Doors
1800 x 600	500 x 400 x 250	• FBPD6180	Sliding Doors
	500 x 400 x 250	• FBPI6180	Sliding Doors
2000 x 600	500 x 400 x 250	• FBPD6200	Sliding Doors

Industrial sink with frame and space for dishwasher

- Designed to incorporate a standard glass washer or dishwasher under the dish drying table.
- Inlaid drain valve and overflow pipe included in each basin.
- 40 x 40 mm square stainless steel legs allow you to raise the height of the unit from 850 to 900 mm.
- Rear legs raised 40mm to allow you to set the frame on a floor with a sanitary radius.
- 105 mm backsplash and 65 mm front panel with rounded safety edges, fully welded.
- **Easy assembly in 3 minutes.**
- **Models with doors are shipped pre-assembled.**
- **Can be shipped fully assembled.**
- Up to 1200 mm: **MF001200**
- Up to 2000 mm: **MF002000**
- **Optional door latches OPC0000**



Total dimensions (mm)	Basin dimensions (mm)	Industrial sink with frame	Industrial sink with frame and shelf	Industrial sink with frame and doors
1200 x 600	500 x 400 x 250	• FBDL0612	• FBDLE612	• FBPDL612 SW
	500 x 400 x 250	• FBIL0612	• FBILE612	• FBPIL612 SW
1400 x 600	500 x 400 x 250	• FBDL0614	• FBDLE614	• FBPDL614 SW
	500 x 400 x 250	• FBIL0614	• FBILE614	• FBPIL614 SW
1800 x 600	500 x 400 x 250	• FBDL0618	• FBDLE618	• FBPDL618 SL
	500 x 400 x 250	• FBIL0618	• FBILE618	• FBPIL618 SL

• **SW** - Swinging Doors / **SL** - Sliding Doors

• **24-hour shipping**

INDUSTRIAL SINKS 700 Series

NEW

Sink

- Made entirely of AISI grade 304 stainless steel (18/10).
- Basins inlaid with sound-proofing protection.
- Inlaid drain valve and overflow pipe included in each basin.
- 105 mm backsplash and 65 mm front panel with rounded safety edges, fully welded.
- Taps not included.

 **Taps** page 33

Frame

- Frames made entirely of stainless steel.
 - The frame adapts easily to the industrial sink thanks to a simple assembly method.
 - This unit's special attachment system allows the industrial sink to fit snugly into the frame, ensuring that there are no gaps.
 - 40 x 40 mm square stainless steel legs allow you to raise the height of the unit from 850 to 900 mm.
 - Rear legs raised 40 mm to allow you to set the frame on a floor with a sanitary radius.
 - Designed to include a lower shelf (optional).
 - **Easy assembly in 3 minutes.**
 - **Can be shipped fully assembled.**
- Up to 1200 mm: **MF001200**
Up to 2000 mm: **MF002000**
Up to 2800 mm: **MF002800**

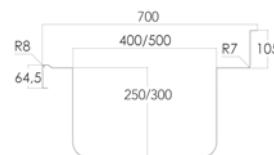

Total dimensions (mm)	Basin dimensions (mm)	Industrial sink	Industrial sink with frame	Industrial sink with frame and shelf
700 x 700	500 x 500 x 300	• L0775510	• FB007070	• FB0E7070
800 x 700	600 x 500 x 300	• L0876510	• FB007080	• FB0E7080
1000 x 700	500 x 500 x 300	• L107551D	• FBD07100	• FBDE7100
	500 x 500 x 300	• L107551I	• FBI07100	• FBIE7100
1200 x 700	400 x 500 x 250	• L1074520	• FB207100	• FB2E7100
	500 x 500 x 300	• L127551D	• FBD07120	• FBDE7120
1200 x 700	500 x 500 x 300	• L127551I	• FBI07120	• FBIE7120
	500 x 500 x 300	• L1275520	• FB207120	• FB2E7120
1300 x 700	600 x 500 x 300	• L137551D	• FBD07130	• FBDE7130
	600 x 500 x 300	• L137551I	• FBI07130	• FBIE7130
1400 x 700	600 x 500 x 300	• L147651D	• FBD07140	• FBDE7140
	600 x 500 x 300	• L147651I	• FBI07140	• FBIE7140
1600 x 700	600 x 500 x 300	• L1476520	• FB207140	• FB2E7140
	500 x 500 x 300	• L167552D	• FBD07160	• FBDE7160
1600 x 700	500 x 500 x 300	• L167552I	• FBI07160	• FBIE7160
	500 x 500 x 300	• L187552D	• FBD07180	• FBDE7180
1800 x 700	500 x 500 x 300	• L187552I	• FBI07180	• FBIE7180
	500 x 500 x 300	• L1875530	• FB307180	• FB3E7180
2000 x 700	600 x 500 x 300	• L217652D	• FBD07200	• FBDE7200
	600 x 500 x 300	• L217652I	• FBI07200	• FBIE7200
2200 x 700	600 x 500 x 300	• L2576522	• FBD07220	• FBDE7220

Plonge avec bâti et portes

- Construction en acier inoxydable AISI 304 18/10.
- Dossieret arrière de 105 mm et bandeau avant de 65 mm avec profil arrondi sanitaire, totalement soudé.
- Pieds carrés en acier inoxydable de 40 x 40 mm pour surélever le meuble de 850 à 900 mm.
- Pieds arrière avancés de 40 mm pour permettre d'installer les bâtis sur un sol avec plinthes sanitaires.
- Disponible avec portes battantes ou coulissantes, selon le modèle.
- Arrière ouvert pour faciliter l'accès aux raccordements.
- **Livrés montés.**
- **Option de serrures sur les portes OPC00001**



Dimensions totales (mm)		Dimensions bac (mm)
700 x 700		500 x 500 x 300
1000 x 700		500 x 500 x 300
		400 x 500 x 250
1200 x 700		500 x 500 x 300
		500 x 500 x 300
1300 x 700		600 x 500 x 300
		600 x 500 x 300
1400 x 700		600 x 500 x 300
		600 x 500 x 300
1600 x 700		500 x 500 x 300
		500 x 500 x 300
1800 x 700		500 x 500 x 300
		500 x 500 x 300
2000 x 700		600 x 500 x 300

Plonge avec bâti et portes	
● FBP07070	Portes battantes
● FBPD7100	Portes coulissantes
● FBPI7100	Portes coulissantes
● FBP27100	Portes coulissantes
● FBPD7120	Portes coulissantes
● FBPI7120	Portes coulissantes
● FBP27120	Portes coulissantes
● FBPD7130	Portes coulissantes
● FBPI7130	Portes coulissantes
● FBPD7140	Portes coulissantes
● FBPI7140	Portes coulissantes
● FBP27140	Portes coulissantes
● FBPD7160	Portes coulissantes
● FBPI7160	Portes coulissantes
● FBPD7180	Portes coulissantes
● FBPI7180	Portes coulissantes
● FBP37180	Portes coulissantes
● FBPD7200	Portes coulissantes

Plonge avec bâti et espace pour lave-vaisselle

- Conçue pour encastrer un lave-vaisselle ou un lave-verres standard sous l'égouttoir.
- Bonde d'évacuation et tuyau de trop-plein dans chaque bac.
- Pieds carrés en acier inoxydable de 40 x 40 mm pour surélever le meuble de 850 à 900 mm.
- Pieds arrière avancés de 40 mm pour permettre de les installer sur un sol avec plinthes sanitaires.
- Dossieret arrière de 105 mm et bandeau avant de 65 mm avec profil arrondi sanitaire, totalement soudé.
- **Facile à monter en 3 minutes.**
- **Les modèles avec portes sont livrés montés.**
- **Peut être livré monté.**
- Jusqu'à 1200 mm : **MF001200**
- Jusqu'à 2000 mm : **MF002000**
- **Option de serrures sur les portes OPC00001**



Dimensions totales (mm)	Dimensions bac (mm)	Plonge avec bâti	Plonge avec bâti et étagère	Plonge avec bâti et portes
1200 x 700		● FBDL0712	● FBDLE712	● FBPDL712 PB
		● FBIL0712	● FBILE712	● FBPIL712 PB
1400 x 700		● FBDL0714	● FBDLE714	● FBPDL714 PB
		● FBIL0714	● FBILE714	● FBPIL714 PB
1800 x 700		● FBDL0718	● FBDLE718	● FBPDL718 PC
		● FBIL0718	● FBILE718	● FBPIL718 PC

- **PB** - Portes battantes / **PC** - Portes coulissantes

● **Expédition en 24 heures**

INDUSTRIAL SINKS

700 Series / High capacity

NEW

Industrial sink

- Made entirely of AISI grade 304 stainless steel (18/10).
- Basins inlaid with sound-proofing protection.
- Inlaid drain valve and overflow pipe included in each basin.
- 105 mm backsplash and 65 mm front panel with rounded safety edges, fully welded.
- Taps not included.

 **Taps** page 33

Frame

- Made entirely of stainless steel.
- The frame adapts easily to the industrial sink thanks to a simple assembly method.
- This unit's special attachment system allows the industrial sink to fit snugly into the frame, ensuring that there are no gaps.
- 40 x 40 mm square stainless steel legs allow you to raise the height of the unit from 850 to 900 mm.
- Rear legs raised 40 mm to allow you to set the frame on a floor with a sanitary radius.
- Designed to include a lower shelf (optional).
- **Easy assembly in 3 minutes.**
- **Can be shipped fully assembled.**
- Up to 1200 mm: **MF001200**
- Up to 2000 mm: **MF002000**



Industrial sink with frame and doors

- Made of AISI grade 304 stainless steel (18/10).
- 40 x 40 mm square stainless steel legs allow you to raise the height of the unit from 850 to 900 mm.
- Rear legs raised 40 mm to allow you to set the frame on a floor with a sanitary radius.
- Suspended sliding doors glide very smoothly. This design does not use bottom runners, facilitating cleaning.
- Open rear section to facilitate access to installations.
- **No assembly required.**
- **Optional door latches OPC00001**

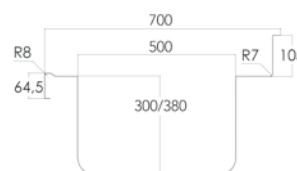

Total Dimensions (mm)	Basin dimensions (mm)	Industrial sink	Industrial sink with frame	Industrial sink with frame and shelf	Industrial sink with frame and doors
1000 x 700	 860 x 500 x 380	• L1078650	• FBG00710	• FBG0E710	• FBPG7100
1200 x 700	 1060 x 500 x 380	• L1271050	• FBG00712	• FBG0E712	• FBPG7120
1400 x 700	 1200 x 500 x 380	• L1471250	• FBG00714	• FBG0E714	• FBPG7140
1600 x 700	 860 x 500 x 380	• L167851D	• FBGD0716	• FBGD0E716	• FBPG716D
	 860 x 500 x 380	• L167851I	• FBGI0716	• FBGIE716	• FBPG716I
1800 x 700	 1160 x 500 x 380	• L187151D	• FBGD0718	• FBGD0E718	• FBPG718D
	 1160 x 500 x 380	• L187151I	• FBGI0718	• FBGIE718	• FBPG718I
1800 x 700	 500 x 500 x 300	• L1875530	• FBG30718	• FBG3E718	• FBPG7183
	 800 x 500 x 380	• L1878520	• FBG20718	• FBG2E718	• FBPG7182
2000 x 700	 1160 x 500 x 380	• L207151D	• FBGD0720	• FBGD0E720	• FBPG720D
	 1160 x 500 x 380	• L207151I	• FBGI0720	• FBGIE720	• FBPG720I

• **24-hour shipping**

INDUSTRIAL SINKS

With basin and waste chute

Industrial sink

- Made entirely of AISI grade 304 stainless steel (18/10).
- 105 mm backsplash and 65 mm front panel with rounded safety edges, fully welded.
- Basin with inlaid drain valve and overflow pipe included.
- Countertop waste hole with rubber ring for throwing trash directly into a bin beneath the counter.

Frame

- Made entirely of stainless steel.
 - 40 x 40 mm square stainless steel legs allow you to raise the height of the unit from 850 to 900 mm.
 - Waste container not included.
 - **Easy assembly in 3 minutes.**
 - **Can also be shipped fully assembled.**
- Up to 1200 mm: **MF001200**
Up to 2000 mm: **MF002000**



Taps page 33 Waste containers pg. 143

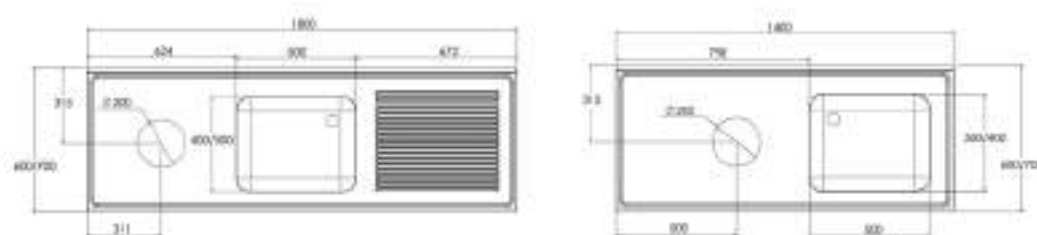

600 Series

Total dimensions (mm)	Basin dimensions (mm)	Industrial sink	Industrial sink with frame	Industrial sink with frame and space for dishwasher
1400 x 600	500 x 400 x 300	• LFAD146D	• FBAD0614	–
	500 x 400 x 300	• LFAD146I	• FBAD0614	–
1800 x 600	500 x 400 x 250	• LFAD186D	• FBAD0618	• FBADL618
	500 x 400 x 250	• LFAD186I	• FBAD0618	• FBAIL618

700 Series

Total dimensions (mm)	Basin dimensions (mm)	Industrial sink	Industrial sink with frame	Industrial sink with frame and space for dishwasher
1400 x 700	500 x 500 x 300	• LFAD147D	• FBAD0714	–
	500 x 500 x 300	• LFAD147I	• FBAD0714	–
1800 x 700	500 x 500 x 250	• LFAD187D	• FBAD0718	• FBADL718
	500 x 500 x 250	• LFAD187I	• FBAD0718	• FBAIL718

• 24-hour shipping

INDUSTRIAL SINKS

Food preparation

Table for preparing vegetables, meat, and fish

- **Specifically designed for the preparation of fresh foods.**
- Made of AISI grade 304 (18/10) brushed stainless steel.
- 105 mm backsplash and 65 mm front panel with rounded safety edges, fully welded.
- Countertop waste chute with rubber ring for throwing trash directly into a bin (not included) beneath the counter.
- 40 x 40 mm square stainless steel legs allow you to raise the height of the unit from 850 to 900 mm.
- Rear legs raised 40 mm to allow you to set the frame on a floor with a sanitary radius.
- The vegetable cutting table includes a large-capacity basin with drain valve; GN containers 1/3, 1/2, 1/1, 2/3 can be placed inside. Also includes 20mm thick polyethylene cutting board.
- Table for meat and fish includes a perforated tray for draining or defrosting. Recess in diamond-tip finish with $\varnothing 17$ mm drain in center.
- Taps and waste container not included.
- **Easy assembly in 3 minutes.**
- **Can be shipped fully assembled.**
Up to 2000 mm: **MF002000**

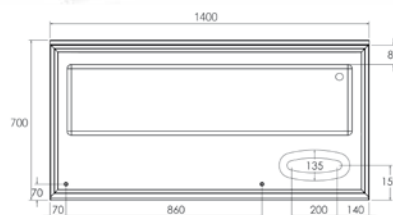

 **Taps** page 33

 **Waste containers** page 143

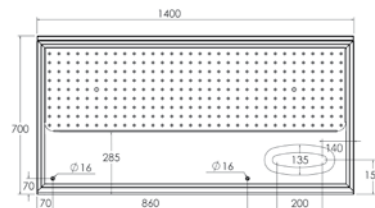

700 Series

Model	Total dimensions (mm)	Basin dimensions (mm)	Countertop	Countertop with frame
Preparation table for vegetables	1400 x 700 x 850	1250 x 310 x 170	• LMLV1470	• FBV07014
Preparation table for meat and fish	1400 x 700 x 850	—	• LMPC1470	• FBC07014

Waste Industrial sink

- **Designed for filling and emptying large containers.**
- Made entirely of stainless steel.
- Includes movable grille to support large containers.
- 105 mm backsplash and 65 mm front panel with rounded safety edges, fully welded.
- 40 x 40 mm square stainless steel legs allow you to raise the height of the unit from 555 to 605 mm.
- Rear legs raised 40 mm to allow you to set the frame on a floor with a sanitary radius.
- **No assembly required.**

Total Dimensions (mm)	Basin dimensions (mm)	Code
600 x 600 x 555	500 x 400 x 250	• FBV66055
700 x 700 x 555	500 x 500 x 300	• FBV77055

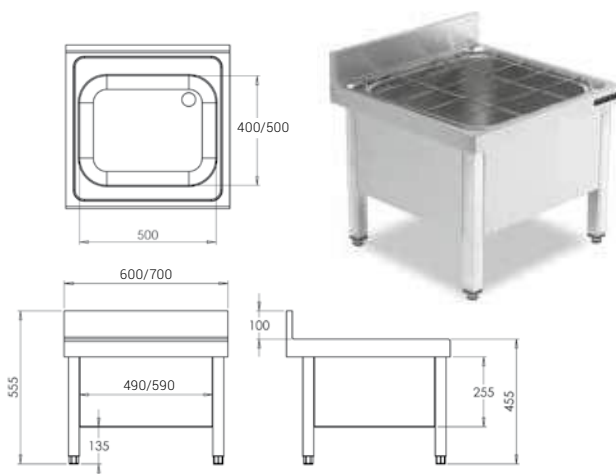

• **24-hour shipping**

INDUSTRIAL SINKS

Accessories

Detachable side splash for industrial sinks

- Made of AISI grade 304 stainless steel (18/10).
- This item's design is very solid and makes assembly easy.
- Included with any Distform industrial sink.



Model	Side	Code
550 Series	Right	• CPE00011
	Left	• CPE00012
600 Series	Right	• CPE00001
	Left	• CPE00002
700 Series	Right	• CPE00003
	Left	• CPE00004

Perforated bases for industrial sinks

- Perforated bases make cleaning food easier, keeping it off the bottom of the sink.
- Made entirely of AISI grade 304 brushed stainless steel (18/10).



Total dimensions (mm)	Drain placement	Code
500 x 400	Right	• R005400D
	Left	• R005400I
500 x 500	Right	• R005500D
	Left	• R005500I
600 x 500	Right	• R006500D
	Left	• R006500I

Tap hole

- Hole that is 33 mm in diameter
- For a frame with space for a washing machine, the hole cannot be between the strainer and the tray.

Model	Position	Code
Right		• LAVAA0001
Left		• LAVAA0002
Center		• LAVAA0003
Between basins		• LAVAA0004

Industrial sink supports

- Made of AISI grade 304 stainless steel (18/10).
- For the 600 / 700 Series
- Price per unit.



Model	Code
Support with leg	• F0020309
Wall mount	• F0020310

Additional shelf for frame

Dimensions (mm)	550 Series	600 Series	700 Series
600	-	• FBE60060	-
700	-	• FBE60070	• FBE70070
800	-	-	• FBE70080
1000	• FBE55100	• FBE60100	• FBE70100
1200	• FBE55120	• FBE60120	• FBE70120
1300	-	• FBE60130	• FBE70130
1400	• FBE55140	• FBE60140	• FBE70140
1600	-	• FBE60160	• FBE70160
1800	-	• FBE60180	• FBE70180
2000	-	• FBE60200	• FBE70200
2200	-	-	• FBE70220

Additional shelf for frame with space for dishwasher

Dimensions (mm)	550 Series	600 Series	700 Series
1200	• FBEL5512	• FBEL6012	• FBEL7012
1400	• FBEL5514	• FBEL6014	• FBEL7014
1800	-	• FBEL6018	• FBEL7018

• 24-hour shipping

HAND SINKS

Wall-mounted

Wall-mounted hand sinks

- Made entirely of stainless steel.
- **Swivel spout model:** Tap has swivel spout and pedal.
- **Electronic tap model:** Electronic tap with 230V/1/50 Hz electrical connection.
- Hot and cold water mixing valve.

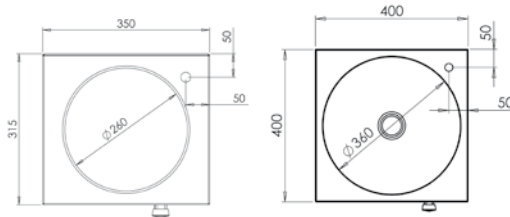

Swivel spout

Model	Total dimensions (mm)	Basin dimensions (mm)	Code
Swivel spout	350 x 315 x 120	Ø 260 x 100	• F0253000
Swivel spout	400 x 400 x 173	Ø 360 x 130	• F0252000
Swivel spout + soap dispenser	400 x 400 x 173	Ø 360 x 130	• F0252001

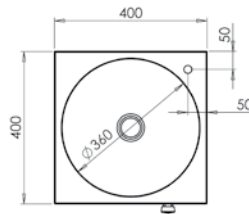

Electronic tap

Model	Total dimensions (mm)	Basin dimensions (mm)	Code
Electronic tap	400 x 400 x 173	Ø 360 x 130	• F0252200
Electronic tap + soap dispenser	400 x 400 x 173	Ø 360 x 130	• F0252201

Wall backsplash for hand sinks

- Made entirely of stainless steel.
- Easy assembly on all hand sinks except for model F0253000.

Total dimensions (mm)	Code
400 x 300 x 23	• F0250301



• 24-hour shipping

HAND SINKS

Freestanding

Freestanding hand sinks

- Made entirely of stainless steel.
- Ø360 x 130 mm basin.
- Tap has swivel spout and foot pedal or electronic tap, depending on the model.
- Electronic tap with 230V/1/50 Hz electrical connection.
- The hand sink with two pedals includes one for hot water and one for cold.
- Hot and cold water mixing valve.
- Removable front door.

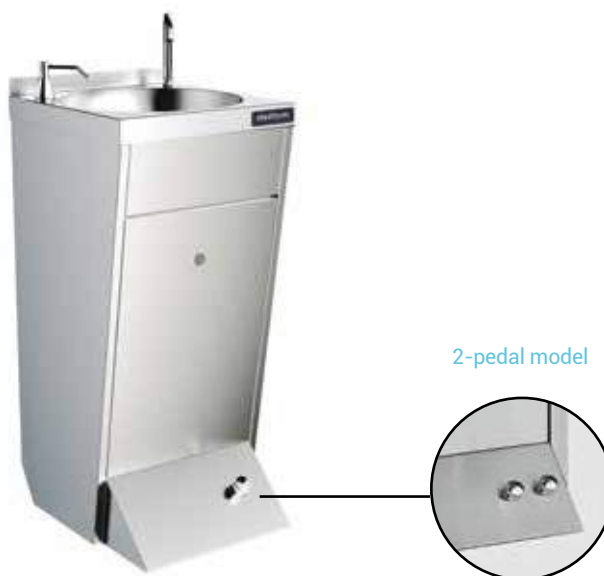

Swivel spout

Model	Total dimensions (mm)	Code
Swivel spout	400 x 440 x 850	• F0251000
Swivel spout + soap dispenser	400 x 440 x 850	• F0251001
Swivel spout + 2 pedals	400 x 440 x 850	• F0251200
Swivel spout + 2 pedals + soap dispenser	400 x 440 x 850	• F0251201

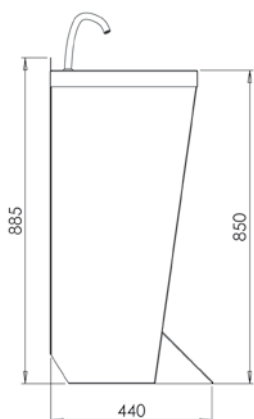
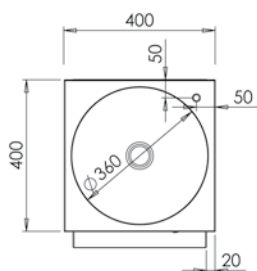

Electronic tap

Model	Total dimensions (mm)	Code
Electronic tap	400 x 440 x 850	• F0251300
Electronic tap + soap dispenser	400 x 440 x 850	• F0251301

• 24-hour shipping

WASHING AREAS

Tables for Dishwashers

NEW

Line of elements for the washing area.
 This section includes tables for washing and waste removal.

All products have universal clamps, which can be adapted to any kind of dishwasher



Tables with waste chutes

- Made of AISI 304 stainless steel (18/10).
- 65 mm fully welded front panel with sanitary radius, fully welded.
- Reinforcement omega brackets are attached with an anti-vibration sound-proof adhesive.
- 40 x 40 mm square stainless steel legs allow you to raise the height of the unit from 850 to 900 mm.
- No-drip edge
- Black rubber easy-install waste chute ring
- **Easy assembly in 3 minutes.**
- **Can be shipped fully assembled.**

Up to 1200 mm: **MF001200**
Up to 2000 mm: **MF002000**

 **Waste containers** page 143



- **Customizable length available:**
Please indicate the desired length;
Price and code of the upper model.



Total dimensions (mm)	With reinforcing frame
1400 x 700 x 850	• F0501470
1600 x 700 x 850	• F0501670
1800 x 700 x 850	• F0501870
2000 x 700 x 850	• F0502070

With partial shelving
• F05E1470
• F05E1670
• F05E1870
• F05E2070

Tabletop shelf for dish racks

- Made of AISI 304 stainless steel (18/10).
- Ø30 mm tube legs with anchor rod for the table.
- 500 x 500 mm standard dish rack size
- **No assembly required.**

Total dimensions (mm)	Code
1100 x 500	• F0030201
1600 x 500	• F0030202



Inclined wall shelving for dish racks

- Made of AISI 304 stainless steel (18/10).
- Wall-mountable brackets with Ø8 mm drill holes (screws and plugs included)
- **Comes fully welded.**

Total dimensions (mm)	Code
1100 x 500	• F0100301
1600 x 500	• F0100302



• **3-day shipping**

WASHING AREAS

Tables for Dishwashers

Input/output tables

- AISI grade 304 stainless steel (18/10) countertops.
- Stainless steel shelf.
- Quick assembly with Allen keys (included).
- Easy to connect to any dishwasher with universal clamping system.
- Fully reversible. Can be clamped on both sides.
- Smooth sloped surface for quick and easy cleaning.
- 40 x 40 mm square stainless steel legs allow you to raise the height of the unit from 850 to 900 mm.
- 158-mm-high backsplash on wall-facing tables.
- **Easy assembly in 3 minutes.**
- **Can be shipped fully assembled.**
- Up to 1200 mm: **MF001200**
- Up to 2000 mm: **MF002000**
- Up to 2800 mm: **MF002800**



- **Customizable length available:**
Please indicate the desired length;
Price and code of the upper model.

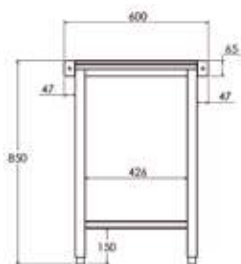

Center table

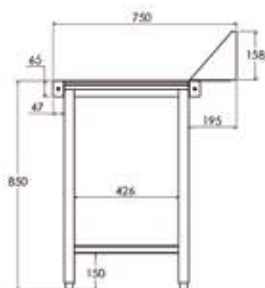

Wall-facing table



Center

Total dimensions (mm)	No shelf	With shelf
600 x 600 x 850	• FESCS066	• FESCE066
1100 x 600 x 850	• FESCS116	• FESCE116
1600 x 600 x 850	• FESCS166	• FESCE166



Wall-facing

Total dimensions (mm)	No shelf	With shelf
700 x 750 x 850	• FESMS077	• FESME077
1100 x 750 x 850	• FESMS117	• FESME117
1600 x 750 x 850	• FESMS167	• FESME167
2100 x 750 x 850	• FESMS217	• FESME217

Accessories for pre-wash tables



Model	Code
Stainless steel prewash basket for 500 x 400 x 250 basin	• ECU00012
Ø 200 mm Waste chute	• CAD00001
Waste hole cover	• RTAPAD01

• 3-day shipping

Pre-Wash tables

- AISI grade 304 stainless steel (18/10) countertops.
- Stainless steel shelf.
- Easy to connect to any dishwasher with universal clamping system.
- Basin with inlaid drain valve and overflow pipe included.
- 40 x 40 mm square stainless steel legs allow you to raise the height of the unit from 850 to 900 mm.
- 158-mm-high backsplash.
- Tap not included.
- **Easy assembly in 3 minutes.**
- **Can be shipped fully assembled.**
- Up to 1200 mm: **MF001200**
- Up to 2000 mm: **MF002000**
- Up to 2800 mm: **MF002800**

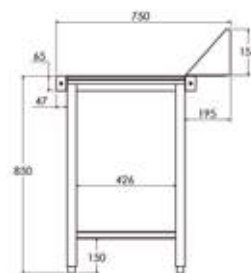

- **Customizable length available:**
Please indicate the desired length;
Price and code of the upper model.



 **Taps** page 33

Total dimensions (mm)	Basin dimensions (mm)	Left basin		Right basin	
		No shelf	With shelf	No shelf	With shelf
700 x 750 x 850	500 x 400 x 250	• FPMSC07I	• FPMEC07I	• FPMSC07D	• FPMEC07D
1100 x 750 x 850	500 x 400 x 250	• FPMSC11I	• FPMEC11I	• FPMSC11D	• FPMEC11D
1600 x 750 x 850	500 x 400 x 250	• FPMSC16I	• FPMEC16I	• FPMSC16D	• FPMEC16D
2100 x 750 x 850	500 x 400 x 250	• FPMSC21I	• FPMEC21I	• FPMSC21D	• FPMEC21D

Pre-wash tables with waste chute

- AISI grade 304 stainless steel (18/10) countertops.
- Stainless steel shelf.
- Basin with inlaid drain valve and overflow pipe included.
- Countertop waste chute with rubber ring for throwing trash directly into a bin beneath the counter.
- 158-mm-high backsplash.
- Tap and waste container not included.
- **Easy assembly in 3 minutes.**
- **Can be shipped fully assembled.**
- Up to 1200 mm: **MF001200**
- Up to 2000 mm: **MF002000**
- Up to 2800 mm: **MF002800**

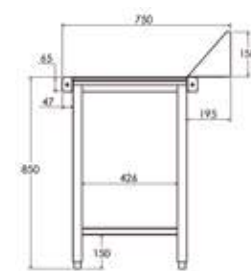

- **Customizable length available:**
Please indicate the desired length;
Price and code of the upper model.



 **Taps** page 33

 **Waste containers** page 143

Total dimensions (mm)	Basin dimensions (mm)	Left basin + Ring		Right basin + Ring	
		No shelf	With shelf	No shelf	With shelf
1100 x 750 x 850	500 x 400 x 250	• FPMAC11I	• FPAEC11I	• FPMAC11D	• FPAEC11D
1600 x 750 x 850	500 x 400 x 250	• FPMAC16I	• FPAEC16I	• FPMAC16D	• FPAEC16D
2100 x 750 x 850	500 x 400 x 250	• FPMAC21I	• FPAEC21I	• FPMAC21D	• FPAEC21D

• **3-day shipping**

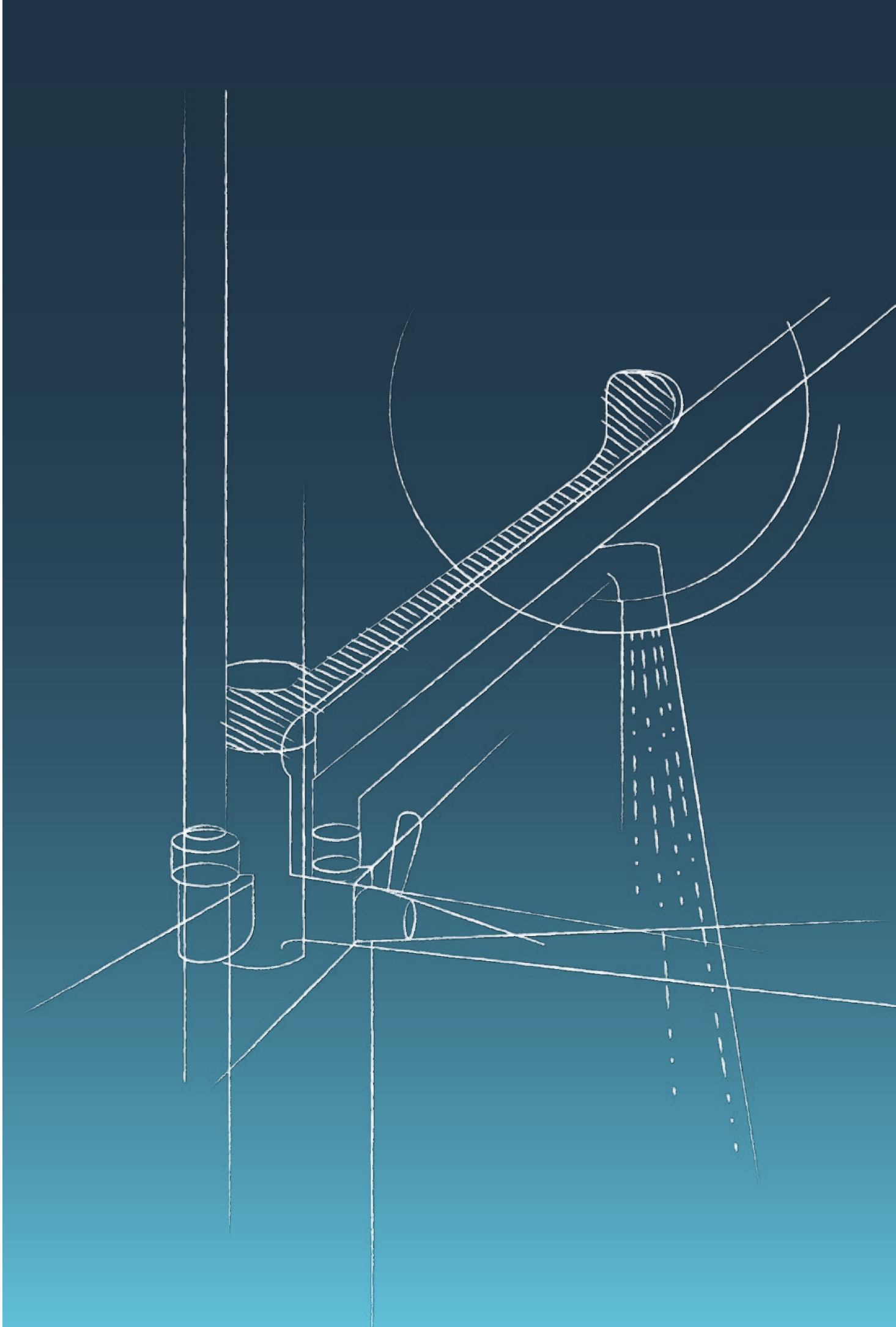

TAPS

Spraying taps	P. 34
Industrial taps	P. 37
Electronic taps	P. 38
Timed taps	P. 39
Extendable taps	P. 39

TAPS

Spraying taps

- High-quality, durable, ergonomic spraying taps designed for intensive use in commercial kitchens.

- Made of high-density chrome-plated brass with stainless steel springs and a flexible tube that is resistant to high temperature and water pressure.
- Includes flexible water connection tubes.
- Includes all accessories necessary for assembly.

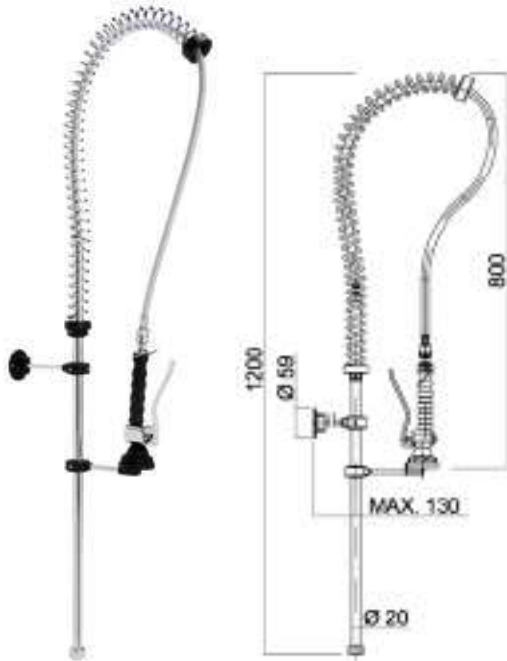

Model	Code
Spraying tap with no temperature controls	• R0020203

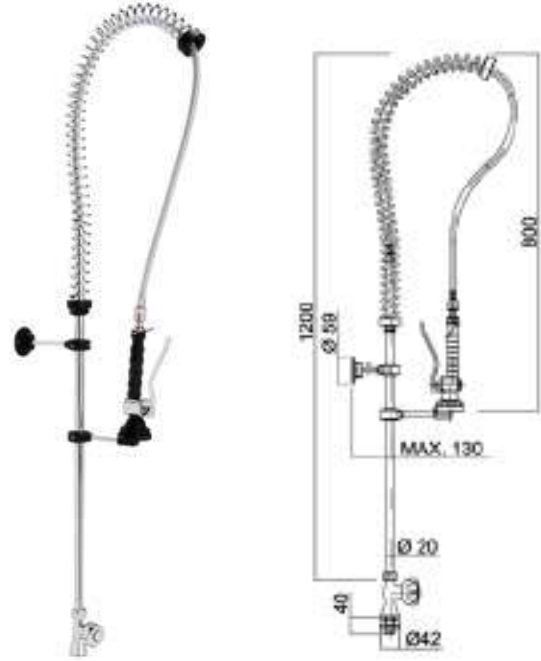

Model	Code
Single temperature spraying tap	• R0020200



Model	Code
Single temperature spraying tap with extra tap	• R0020300

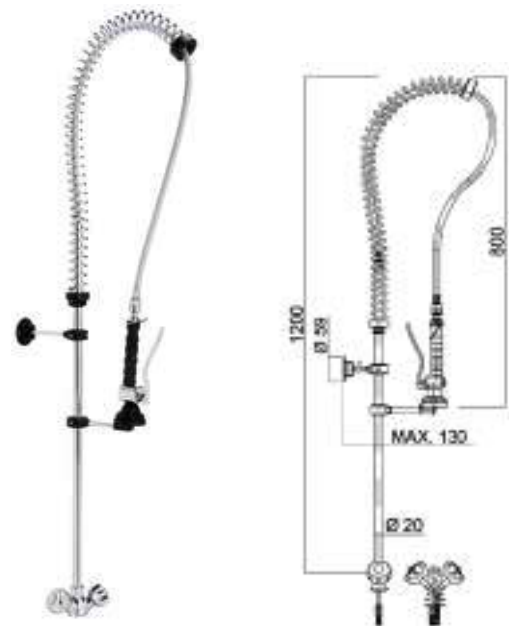

Model	Code
Spraying tap with hot/cold controls	• R0020201

• 24-hour shipping



Model	Code
Single-handle spraying tap	• R0020206

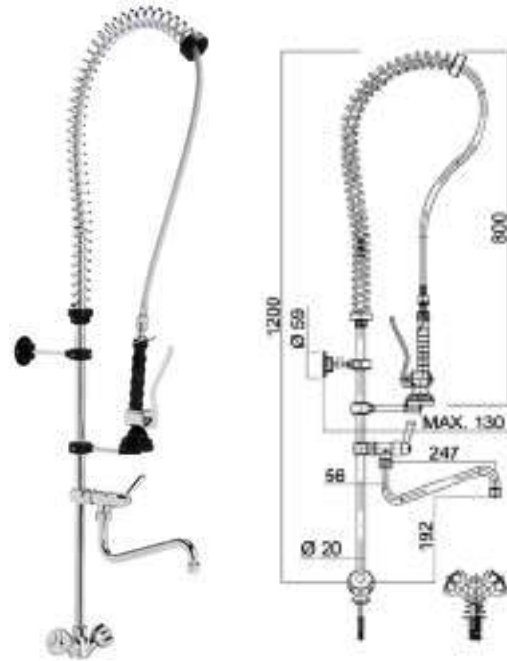

Model	Code
Spraying tap with hot/cold controls and extra tap	• R0020301

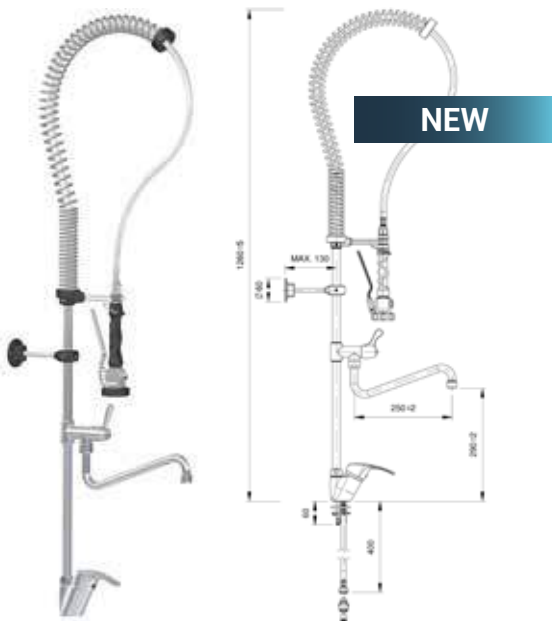

Model	Code
Single-handle Spraying tap with extra tap	• R0020302

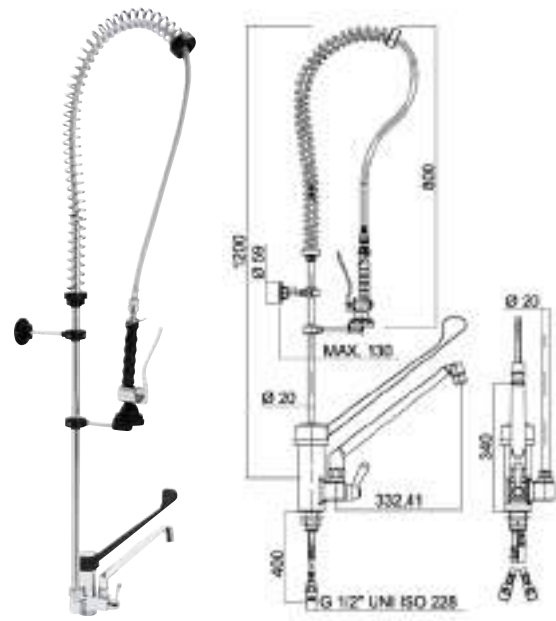

Model	Code
Easy-open spraying tap with extra tap	• R0020216

• 24-hour shipping

TAPS

Spraying taps

- High-quality, durable, ergonomic spraying taps designed for intensive use in commercial kitchens.

- Made of high-density chrome-plated brass with stainless steel springs and a flexible tube that is resistant to high temperature and water pressure.
- Includes flexible water connection tubes.
- Includes all accessories necessary for assembly.

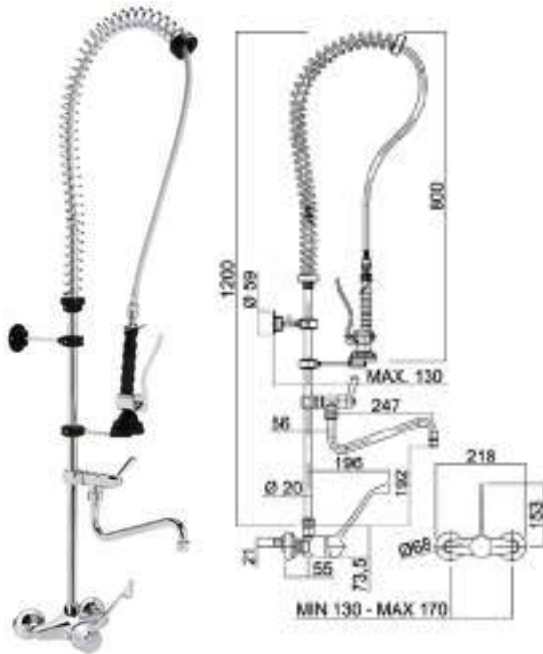

Model	Code
-------	------

Wall-mounted spraying tap with extra tap • R0020218

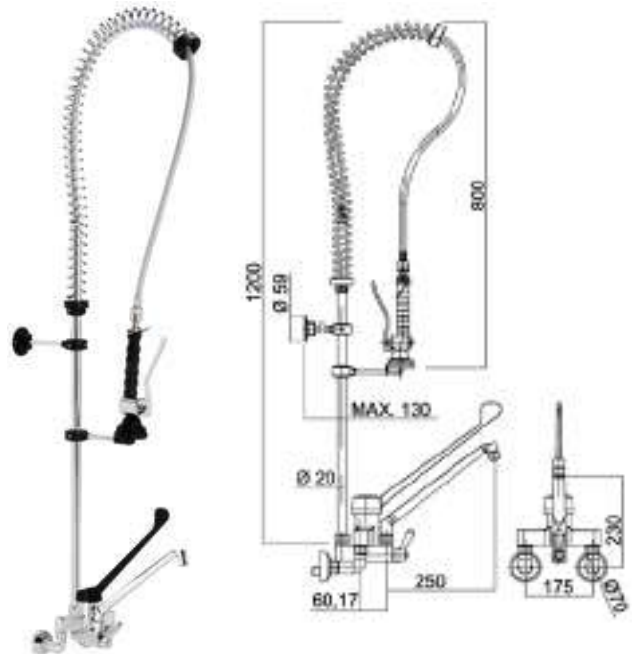

Model	Code
-------	------

Easy-open wall-mounted spraying tap • R0020234

NEW

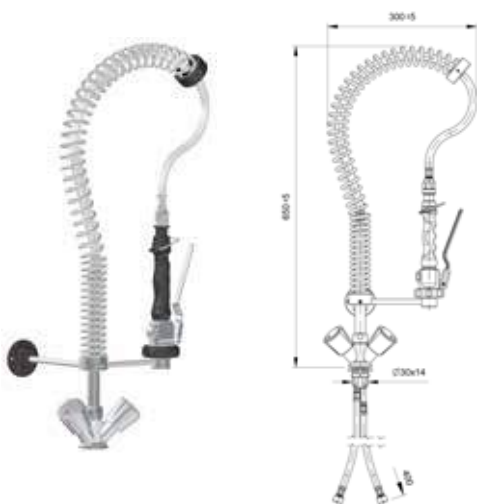

Model	Code
-------	------

600-mm-high hot/cold spray tap • R0020303

NEW

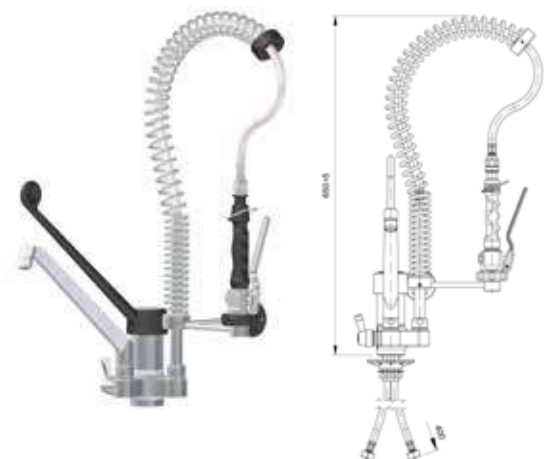

Model	Code
-------	------

600-mm-high easy-open spraying tap with hot/cold controls • R0020306

• 24-hour shipping

Industrial taps

• High-quality, durable spraying taps designed for intensive use in commercial kitchens.

- Made of high-density chrome-plated brass.
- Ergonomic handles facilitate opening and closing the tap and regulating water flow.
- Includes flexible water connection tubes.
- Includes all accessories necessary for assembly.



Model

Code

Low spout tap with short handle

• R0020221



Model

Code

Low spout tap with long handle

• R0020304

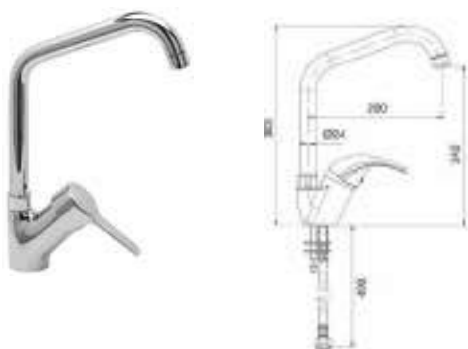

Model

Code

Single-handle high spout tap

• R0020202



Model

Code

Tap with hot/cold controls

• R0020305

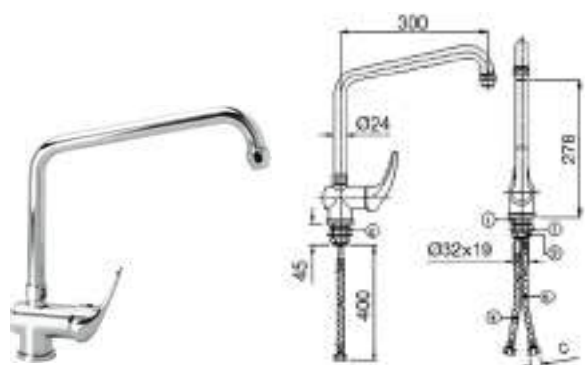

Model

Code

High spout filled tap

• R0020238

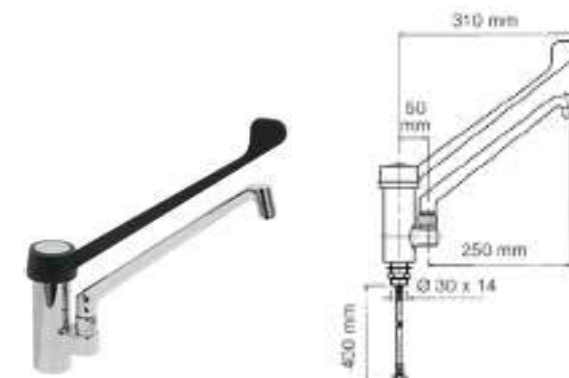

Model

Code

Easy elbow lever tap

• R0020215

• 24-hour shipping

TAPS

Industrial taps

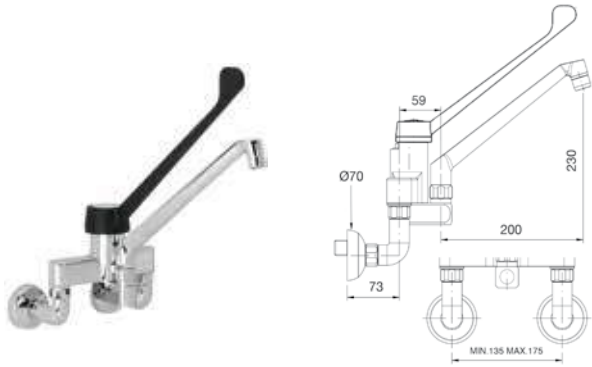

Model	Code
-------	------

Wall-mounted mixing tap with hot/cold controls • R0020222

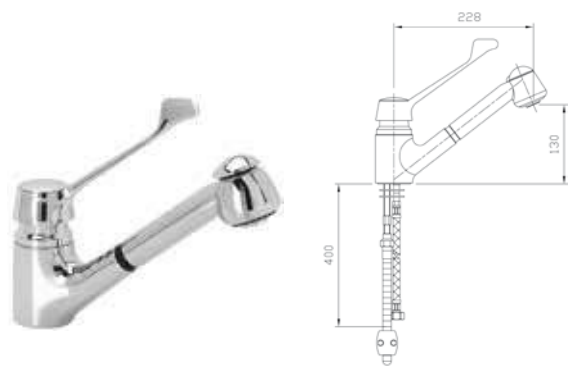

Model	Code
-------	------

Mixing tap with extendable spout and hot/cold controls • R0020223

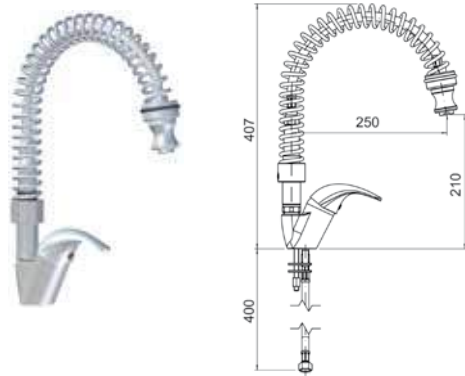

Model	Code
-------	------

Single-handle spiral mixing tap • R0020239

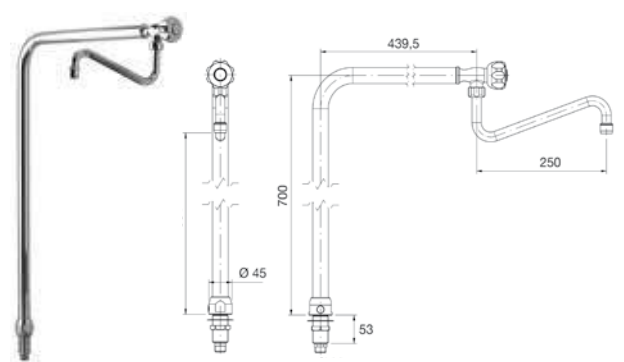

Model	Code
-------	------

Single knob column tap • R0020219

Electronic taps

• Electronic taps for maximum ease of use and sanitation.

- These taps have a built-in electronic sensor; when activated by hand movement, the tap opens, and it closes when you move your hands away.
- Includes flexible water connection tubes.
- Comes in electronic models or battery-operated ones.

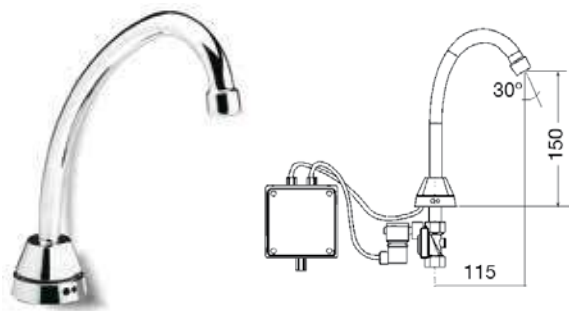

Model	Code
-------	------

High spout electronic network tap • R0020230

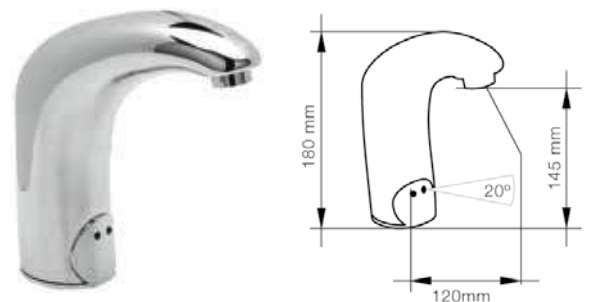

Model	Code
-------	------

Electronic network tap • R0020214

Battery-operated tap • R0020229

• 24-hour shipping

Pedal-operated tap with hot/cold controls

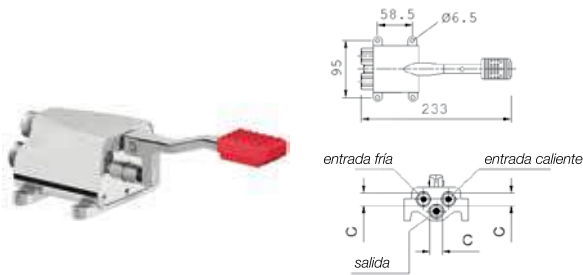

Model	Code
Single hot/cold control pedal	• R0020226

Double pedal-operated tap with hot/cold controls

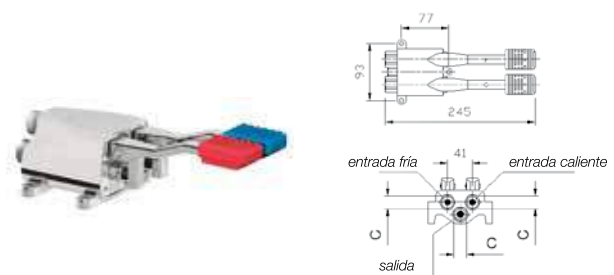

Model	Code
Double hot/cold control pedal	• R0020237

Swivel spout

NEW



Model	Code
High swivel spout tap	• R0020224

Knee-operated timed mixing tap with hot/cold controls

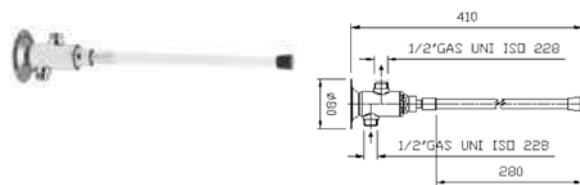

Model	Code
Hot/cold controls, timer and mixing valve	• R0020227
One temperature with timer	• R0020225

Hose extension set with tap

- Extendable taps designed for intensive use in restaurants, pubs, the meat industry, fish markets, catering, and more.
- Made of stainless steel.
- Equipped with temperature-resistant hose for use with foods. Retractable handle that can be set to a certain hose length so the user does not need to exert extra strength.
- Wall installation
- Maximum working pressure: 5 bar.
- Maximum flow at 4 bar: 13 l/min.

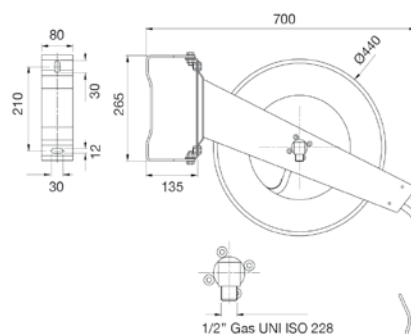

Length	Code
10 meters	• R0020232
15 meters	• R0020235
20 meters	• R0020236

• 24-hour shipping

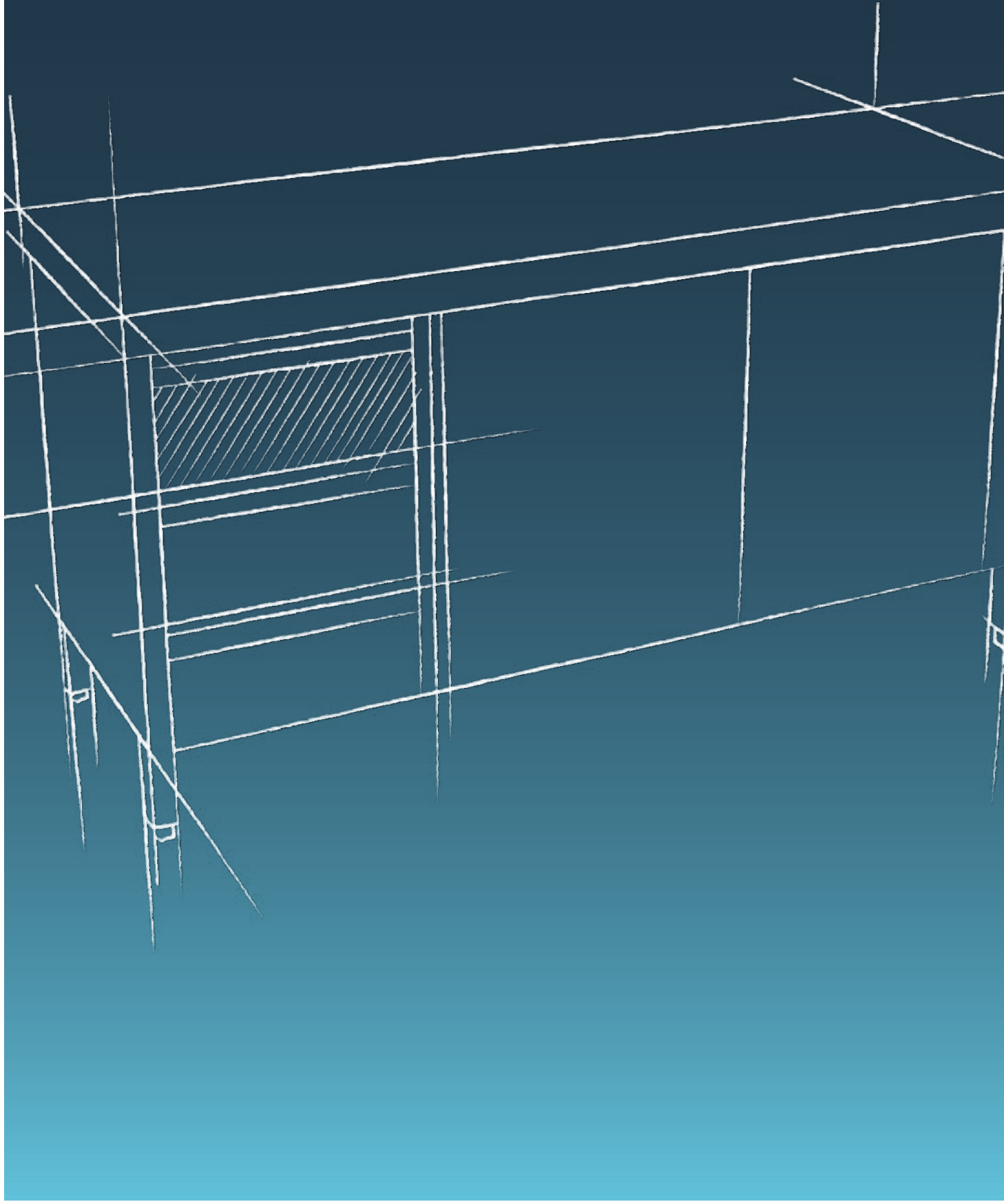

WORK TABLES

500 / 550 Series tables	P. 44
600 Series tables	P. 46
700 Series tables	P. 48
800 Series tables	P. 50
900 Series tables	P. 52
Tables with doors and drawers	P. 54
Tables with basins	P. 56
Tables with no-drip edge and basin	P. 58
Tables with basins, doors, and drawers	P. 60
Center / Wall-facing countertop	P. 62
Wall-facing countertop with basin	P. 63
600-mm-high tables	P. 64
Tables for waste, tables with drawers, and corner tables	P. 66
Accessories	P. 67
Customizations	P. 71
Cooking and preparation support tables	P. 72
Coffee Service and display cabinet tables	P. 73

**HIGH-QUALITY WORK
TABLES. DURABILITY
AND FUNCTIONALITY
WITH NO EQUAL ON
THE MARKET**

New models with
uniform designs.
Customizable length



**IT HAS NEVER
BEEN SO EASY TO
DESIGN YOUR IDEAL
WORKSPACE**

Sound-proof
countertops with
reinforcing omega
brackets



Tables with basins, accessories, and supplements that enhance them customization options



Easy installation in 3 minutes with user-friendly assembly. Can also be shipped fully assembled



105 mm high backsplash with rounded safety edges, fully welded, for wall units



NEW

Uniform design. Versatile with Industrial sinks and other Distform products

Combine them however you want!

WORK TABLES 500 Series

NEW

Center table

- AISI grade 304 brushed stainless steel (18/10) countertops with reinforcing omega brackets.
- Stainless steel shelf.
- 65 mm rounded edge, fully welded front panel.
- 40 x 40 mm square stainless steel legs allow you to raise the height of the unit from 850 to 900 mm.
- **Easy assembly in 3 minutes.**
- **Can be shipped fully assembled.**
Up to 1200 mm: **MF001200**
Up to 2000 mm: **MF002000**
Up to 2800 mm: **MF002800**



- **Customizable length available:**
Please indicate the desired length;
Price and code of the upper model.

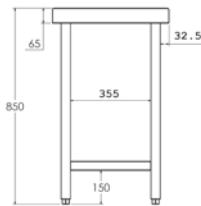

Center with shelf

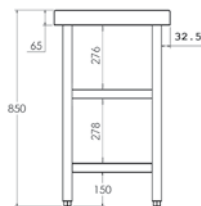

Center with 2 shelves

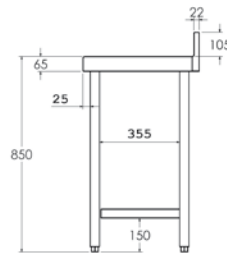

Wall-facing with shelf

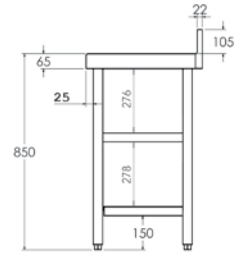

Wall-facing with 2 shelves



500 Series

Total dimensions (mm)	Table with frame for reinforcement	Table with shelf	Table with 2 shelves
600 x 500 x 850	• FC050060	• FC150060	• FC250060
800 x 500 x 850	• FC050080	• FC150080	• FC250080
1000 x 500 x 850	• FC050100	• FC150100	• FC250100
1200 x 500 x 850	• FC050120	• FC150120	• FC250120
1400 x 500 x 850	• FC050140	• FC150140	• FC250140
1500 x 500 x 850	• FC050150	• FC150150	• FC250150
1600 x 500 x 850	• FC050160	• FC150160	• FC250160
1800 x 500 x 850	• FC050180	• FC150180	• FC250180
2000 x 500 x 850	• FC050200	• FC150200	• FC250200
2200 x 500 x 850	• FC050220	• FC150220	• FC250220
2400 x 500 x 850	• FC050240	• FC150240	• FC250240

• 24-hour shipping • 3-day shipping

NEW

500/550 Series

Wall-facing table

- AISI grade 304 brushed stainless steel (18/10) countertops with reinforcing omega brackets.
- Stainless steel shelf.
- 105 mm backsplash and 65 mm front panel with rounded safety edges, fully welded.
- Tables with doors include: side and rear panels, with a middle shelf made of stainless steel.
- 40 x 40 mm square stainless steel legs allow you to raise the height of the unit from 850 to 900 mm.
- **Easy assembly in 3 minutes.**
- **Models with doors are shipped pre-assembled.**
- **Can be shipped fully assembled.**
- Up to 1200 mm: **MF001200**
- Up to 2000 mm: **MF002000**
- Up to 2800 mm: **MF002800**
- Optional door latches **OPC00001**



- **Customizable length available:**
Please indicate the desired length;
Price and code of the upper model.



500 Series



Total dimensions (mm)	Table with frame for reinforcement	Table with shelf	Table with 2 shelves	Table with doors
600 x 500 x 850	• FM050060	• FM150060	• FM250060	-
800 x 500 x 850	• FM050080	• FM150080	• FM250080	• FMP50080 SW
1000 x 500 x 850	• FM050100	• FM150100	• FM250100	• FMP50100 SL
1200 x 500 x 850	• FM050120	• FM150120	• FM250120	• FMP50120 SL
1400 x 500 x 850	• FM050140	• FM150140	• FM250140	• FMP50140 SL
1500 x 500 x 850	• FM050150	• FM150150	• FM250150	-
1600 x 500 x 850	• FM050160	• FM150160	• FM250160	• FMP50160 SL
1800 x 500 x 850	• FM050180	• FM150180	• FM250180	• FMP50180 SL
2000 x 500 x 850	• FM050200	• FM150200	• FM250200	• FMP50200 SL
2200 x 500 x 850	• FM050220	• FM150220	• FM250220	-
2400 x 500 x 850	• FM050240	• FM150240	• FM250240	-

550 Series

Total dimensions (mm)	Table with frame for reinforcement	Table with shelf	Table with 2 shelves	Table with doors
600 x 550 x 850	• FM055060	• FM155060	• FM255060	-
800 x 550 x 850	• FM055080	• FM155080	• FM255080	• FMP55080 SW
1000 x 550 x 850	• FM055100	• FM155100	• FM255100	• FMP55100 SL
1200 x 550 x 850	• FM055120	• FM155120	• FM255120	• FMP55120 SL
1400 x 550 x 850	• FM055140	• FM155140	• FM255140	• FMP55140 SL
1500 x 550 x 850	• FM055150	• FM155150	• FM255150	-
1600 x 550 x 850	• FM055160	• FM155160	• FM255160	• FMP55160 SL
1800 x 550 x 850	• FM055180	• FM155180	• FM255180	• FMP55180 SL
2000 x 550 x 850	• FM055200	• FM155200	• FM255200	• FMP55200 SL
2200 x 550 x 850	• FM055220	• FM155220	• FM255220	-
2400 x 550 x 850	• FM055240	• FM155240	• FM255240	-

- **SW** - Swinging Doors / **SL** - Sliding Doors

• **24-hour shipping**

• **3-day shipping**

WORK TABLES 600 Series

NEW

Center table

- AISI grade 304 brushed stainless steel (18/10) countertops with reinforcing omega brackets.
- Stainless steel shelf.
- 65 mm rounded edge, fully welded front panel.
- Tables with doors include: side and rear panels, with a middle shelf made of stainless steel.
- 40 x 40 mm square stainless steel legs allow you to raise the height of the unit from 850 to 900 mm.
- **Easy assembly in 3 minutes.**
- **Models with doors are shipped pre-assembled.**
- **Can be shipped fully assembled.**
- Up to 1200 mm: **MF001200**
- Up to 2000 mm: **MF002000**
- Up to 2800 mm: **MF002800**
- **Optional door latches OPC00001**



- **Customizable length available:**
Please indicate the desired length;
Price and code of the upper model.

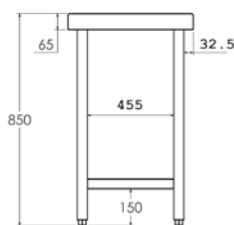

Center with 1 shelf

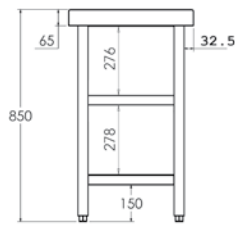

Center with 2 shelves



Total dimensions (mm)	Table with reinforcing frame	Table with 1 shelf	Table with 2 shelves	Table with doors	Table with pass-through sliding doors
600 x 600 x 850	• FC060060	• FC160060	• FC260060	-	-
700 x 600 x 850	• FC060070	• FC160070	• FC260070	-	-
800 x 600 x 850	• FC060080	• FC160080	• FC260080	• FCP60080 SW	-
900 x 600 x 850	• FC060090	• FC160090	• FC260090	-	-
1000 x 600 x 850	• FC060100	• FC160100	• FC260100	• FCP60100 SL	• FCPP6100
1100 x 600 x 850	• FC060110	• FC160110	• FC260110	-	-
1200 x 600 x 850	• FC060120	• FC160120	• FC260120	• FCP60120 SL	• FCPP6120
1300 x 600 x 850	• FC060130	• FC160130	• FC260130	-	-
1400 x 600 x 850	• FC060140	• FC160140	• FC260140	• FCP60140 SL	• FCPP6140
1500 x 600 x 850	• FC060150	• FC160150	• FC260150	-	-
1600 x 600 x 850	• FC060160	• FC160160	• FC260160	• FCP60160 SL	• FCPP6160
1700 x 600 x 850	• FC060170	• FC160170	• FC260170	-	-
1800 x 600 x 850	• FC060180	• FC160180	• FC260180	• FCP60180 SL	• FCPP6180
1900 x 600 x 850	• FC060190	• FC160190	• FC260190	-	-
2000 x 600 x 850	• FC060200	• FC160200	• FC260200	• FCP60200 SL	• FCPP6200
2200 x 600 x 850	• FC060220	• FC160220	• FC260220	• FCP60220 SL	• FCPP6220
2400 x 600 x 850	• FC060240	• FC160240	• FC260240	• FCP60240 SL	• FCPP6240
2600 x 600 x 850	• FC060260	• FC160260	• FC260260	• FCP60260 SL	• FCPP6260
2800 x 600 x 850	• FC060280	• FC160280	• FC260280	• FCP60280 SL	• FCPP6280

• **SW** - Swinging Doors / **SL** - Sliding Doors

• **24-hour shipping**

• **3-day shipping**

600 Series

Wall-facing table

- AISI grade 304 brushed stainless steel (18/10) countertops with reinforcing omega brackets.
- Stainless steel shelf.
- 105 mm backsplash and 65 mm front panel with rounded safety edges, fully welded.
- Tables with doors include: side and rear panels, with a middle shelf made of stainless steel.
- 40 x 40 mm square stainless steel legs allow you to raise the height of the unit from 850 to 900 mm.
- **Easy assembly in 3 minutes.**
- **Models with doors are shipped pre-assembled.**
- **Can be shipped fully assembled.**
- Up to 1200 mm: **MF001200**
- Up to 2000 mm: **MF002000**
- Up to 2800 mm: **MF002800**
- Optional door latches **OPC00001**

 • **Customizable length available:**
Please indicate the desired length;
Price and code of the upper model.

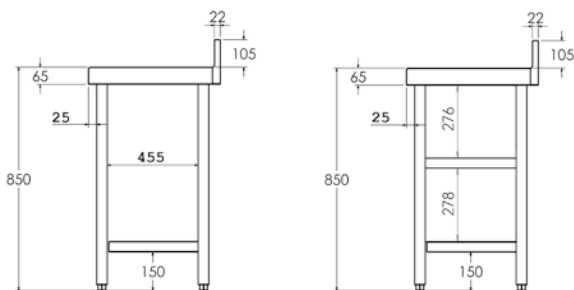

Wall-facing with 1 shelf

Wall-facing with 2 shelves



Total dimensions (mm)	Table with reinforcing frame	Table with 1 shelf	Table with 2 shelves	Table with doors
600 x 600 x 850	• FM061060	• FM161060	• FM260060	-
700 x 600 x 850	• FM061070	• FM161070	• FM260070	-
800 x 600 x 850	• FM060080	• FM160080	• FM260080	• FMP60080 SW
900 x 600 x 850	• FM060090	• FM160090	• FM260090	-
1000 x 600 x 850	• FM060100	• FM160100	• FM260100	• FMP60100 SL
1100 x 600 x 850	• FM060110	• FM160110	• FM260110	-
1200 x 600 x 850	• FM060120	• FM160120	• FM260120	• FMP60120 SL
1300 x 600 x 850	• FM060130	• FM160130	• FM260130	-
1400 x 600 x 850	• FM060140	• FM160140	• FM260140	• FMP60140 SL
1500 x 600 x 850	• FM060150	• FM160150	• FM260150	-
1600 x 600 x 850	• FM060160	• FM160160	• FM260160	• FMP60160 SL
1700 x 600 x 850	• FM060170	• FM160170	• FM260170	-
1800 x 600 x 850	• FM060180	• FM160180	• FM260180	• FMP60180 SL
1900 x 600 x 850	• FM060190	• FM160190	• FM260190	-
2000 x 600 x 850	• FM060200	• FM160200	• FM260200	• FMP60200 SL
2200 x 600 x 850	• FM060220	• FM160220	• FM260220	• FMP60220 SL
2400 x 600 x 850	• FM060240	• FM160240	• FM260240	• FMP60240 SL
2600 x 600 x 850	• FM060260	• FM160260	• FM260260	• FMP60260 SL
2800 x 600 x 850	• FM060280	• FM160280	• FM260280	• FMP60280 SL

• **SW** - Swinging Doors / **SL** - Sliding Doors

• **24-hour shipping**

• **3-day shipping**

WORK TABLES 700 Series

NEW

Center table

- AISI grade 304 brushed stainless steel (18/10) countertops with reinforcing omega brackets.
- Stainless steel shelf.
- 65 mm rounded edge, fully welded front panel.
- Tables with doors include: side and rear panels, with a middle shelf made of stainless steel.
- 40 x 40 mm square stainless steel legs allow you to raise the height of the unit from 850 to 900 mm.
- **Easy assembly in 3 minutes.**
- **Models with doors are shipped pre-assembled.**
- **Can be shipped fully assembled.**
Up to 1200 mm: **MF001200**
Up to 2000 mm: **MF002000**
Up to 2800 mm: **MF002800**
- **Optional door latches OPC00001**



- **Customizable length available:**
Please indicate the desired length;
Price and code of the upper model.

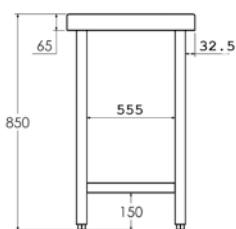

Center with 1 shelf

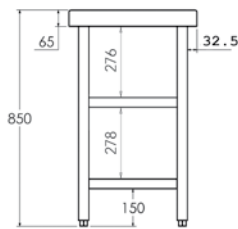

Center with 2 shelves



Total dimensions (mm)	Table with reinforcing frame	Table with 1 shelf	Table with 2 shelves	Table with doors	Table with pass-through sliding doors
600 x 700 x 850	• FC070060	• FC170060	• FC270060	-	-
700 x 700 x 850	• FC070070	• FC170070	• FC270070	-	-
800 x 700 x 850	• FC070080	• FC170080	• FC270080	• FCP70080 SW	-
900 x 700 x 850	• FC070090	• FC170090	• FC270090	-	-
1000 x 700 x 850	• FC070100	• FC170100	• FC270100	• FCP70100 SL	• FCPP7100
1100 x 700 x 850	• FC070110	• FC170110	• FC270110	-	-
1200 x 700 x 850	• FC070120	• FC170120	• FC270120	• FCP70120 SL	• FCPP7120
1300 x 700 x 850	• FC070130	• FC170130	• FC270130	-	-
1400 x 700 x 850	• FC070140	• FC170140	• FC270140	• FCP70140 SL	• FCPP7140
1500 x 700 x 850	• FC070150	• FC170150	• FC270150	-	-
1600 x 700 x 850	• FC070160	• FC170160	• FC270160	• FCP70160 SL	• FCPP7160
1700 x 700 x 850	• FC070170	• FC170170	• FC270170	-	-
1800 x 700 x 850	• FC070180	• FC170180	• FC270180	• FCP70180 SL	• FCPP7180
1900 x 700 x 850	• FC070190	• FC170190	• FC270190	-	-
2000 x 700 x 850	• FC070200	• FC170200	• FC270200	• FCP70200 SL	• FCPP7200
2200 x 700 x 850	• FC070220	• FC170220	• FC270220	• FCP70220 SL	• FCPP7220
2400 x 700 x 850	• FC070240	• FC170240	• FC270240	• FCP70240 SL	• FCPP7240
2600 x 700 x 850	• FC070260	• FC170260	• FC270260	• FCP70260 SL	• FCPP7260
2800 x 700 x 850	• FC070280	• FC170280	• FC270280	• FCP70280 SL	• FCPP7280

• **SW** - Swinging Doors / **SL** - Sliding Doors

• **24-hour shipping**

• **3-day shipping**

700 Series

Wall-facing table

- AISI grade 304 brushed stainless steel (18/10) countertops with reinforcing omega brackets.
- Stainless steel shelf.
- 105 mm backsplash and 65 mm front panel with rounded safety edges, fully welded.
- Tables with doors include: side and rear panels, with a middle shelf made of stainless steel.
- 40 x 40 mm square stainless steel legs allow you to raise the height of the unit from 850 to 900 mm.
- **Easy assembly in 3 minutes.**
- **Models with doors are shipped pre-assembled.**
- **Can be shipped fully assembled.**
- Up to 1200 mm: **MF001200**
- Up to 2000 mm: **MF002000**
- Up to 2800 mm: **MF002800**
- Optional door latches **OPC00001**

 **• Customizable length available:**
Please indicate the desired length;
Price and code of the upper model.

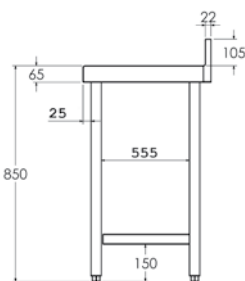

Wall-facing with 1 shelf

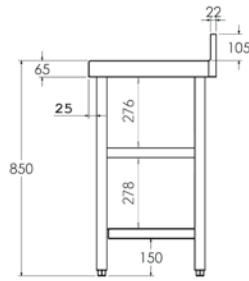

Wall-facing with 2 shelves



Total dimensions (mm)	Table with reinforcing frame	Table with 1 shelf	Table with 2 shelves	Table with doors
600 x 700 x 850	• FM070060	• FM170060	• FM270060	-
700 x 700 x 850	• FM071070	• FM170070	• FM270070	-
800 x 700 x 850	• FM070080	• FM170080	• FM270080	• FMP70080 SW
900 x 700 x 850	• FM070090	• FM170090	• FM270090	-
1000 x 700 x 850	• FM070100	• FM170100	• FM270100	• FMP70100 SL
1100 x 700 x 850	• FM070110	• FM170110	• FM270110	-
1200 x 700 x 850	• FM070120	• FM170120	• FM270120	• FMP70120 SL
1300 x 700 x 850	• FM070130	• FM170130	• FM270130	-
1400 x 700 x 850	• FM070140	• FM170140	• FM270140	• FMP70140 SL
1500 x 700 x 850	• FM070150	• FM170150	• FM270150	-
1600 x 700 x 850	• FM070160	• FM170160	• FM270160	• FMP70160 SL
1700 x 700 x 850	• FM070170	• FM170170	• FM270170	-
1800 x 700 x 850	• FM070180	• FM170180	• FM270180	• FMP70180 SL
1900 x 700 x 850	• FM070190	• FM170190	• FM270190	-
2000 x 700 x 850	• FM070200	• FM170200	• FM270200	• FMP70200 SL
2200 x 700 x 850	• FM070220	• FM170220	• FM270220	• FMP70220 SL
2400 x 700 x 850	• FM070240	• FM170240	• FM270240	• FMP70240 SL
2600 x 700 x 850	• FM070260	• FM170260	• FM270260	• FMP70260 SL
2800 x 700 x 850	• FM070280	• FM170280	• FM270280	• FMP70280 SL

• **SW** - Swinging Doors / **SL** - Sliding Doors

• **24-hour shipping**

• **3-day shipping**

WORK TABLES 800 Series

NEW

Center table

- AISI grade 304 brushed stainless steel (18/10) countertops with reinforcing omega brackets.
- Stainless steel shelf.
- 65 mm rounded edge, fully welded front panel.
- Tables with doors include: side and rear panels, with a middle shelf made of stainless steel.
- 40 x 40 mm square stainless steel legs allow you to raise the height of the unit from 850 to 900 mm.
- **Easy assembly in 3 minutes.**
- **Models with doors are shipped pre-assembled.**
- **Can be shipped fully assembled.**
- Up to 1200 mm: **MF001200**
- Up to 2000 mm: **MF002000**
- Up to 2800 mm: **MF002800**
- Optional door latches **OPC00001**



- **Customizable length available:**
Please indicate the desired length;
Price and code of the upper model.

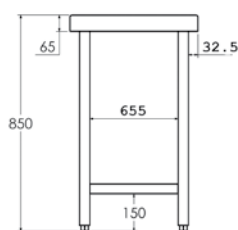

Center with 1 shelf

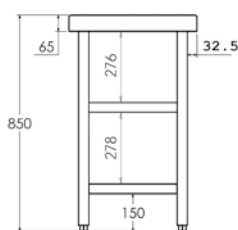

Center with 2 shelves



Total dimensions (mm)	Table with reinforcing frame	Table with 1 shelf	Table with 2 shelves	Table with doors	Table with pass-through sliding doors
600 x 800 x 850	• FC080060	• FC180060	• FC280060	-	-
700 x 800 x 850	• FC080070	• FC180070	• FC280070	-	-
800 x 800 x 850	• FC080080	• FC180080	• FC280080	• FCP80080 SW	-
900 x 800 x 850	• FC080090	• FC180090	• FC280090	-	-
1000 x 800 x 850	• FC080100	• FC180100	• FC280100	• FCP80100 SL	• FCPP8100
1100 x 800 x 850	• FC080110	• FC180110	• FC280110	-	-
1200 x 800 x 850	• FC080120	• FC180120	• FC280120	• FCP80120 SL	• FCPP8120
1300 x 800 x 850	• FC080130	• FC180130	• FC280130	-	-
1400 x 800 x 850	• FC080140	• FC180140	• FC280140	• FCP80140 SL	• FCPP8140
1500 x 800 x 850	• FC080150	• FC180150	• FC280150	-	-
1600 x 800 x 850	• FC080160	• FC180160	• FC280160	• FCP80160 SL	• FCPP8160
1700 x 800 x 850	• FC080170	• FC180170	• FC280170	-	-
1800 x 800 x 850	• FC080180	• FC180180	• FC280180	• FCP80180 SL	• FCPP8180
1900 x 800 x 850	• FC080190	• FC180190	• FC280190	-	-
2000 x 800 x 850	• FC080200	• FC180200	• FC280200	• FCP80200 SL	• FCPP8200
2200 x 800 x 850	• FC080220	• FC180220	• FC280220	• FCP80220 SL	• FCPP8220
2400 x 800 x 850	• FC080240	• FC180240	• FC280240	• FCP80240 SL	• FCPP8240
2600 x 800 x 850	• FC080260	• FC180260	• FC280260	• FCP80260 SL	• FCPP8260
2800 x 800 x 850	• FC080280	• FC180280	• FC280280	• FCP80280 SL	• FCPP8280

• **SW** - Swinging Doors / **SL** - Sliding Doors

• **24-hour shipping**

• **3-day shipping**

800 Series

Wall-facing table

- AISI grade 304 brushed stainless steel (18/10) countertops with reinforcing omega brackets.
- Stainless steel shelf.
- 105 mm backsplash and 65 mm front panel with rounded safety edges, fully welded.
- Tables with doors include: side and rear panels, with a middle shelf made of stainless steel.
- 40 x 40 mm square stainless steel legs allow you to raise the height of the unit from 850 to 900 mm.
- **Easy assembly in 3 minutes.**
- **Models with doors are shipped pre-assembled.**
- **Can be shipped fully assembled.**
- Up to 1200 mm: **MF001200**
- Up to 2000 mm: **MF002000**
- Up to 2800 mm: **MF002800**
- Optional door latches **OPC00001**



- **Customizable length available:**
Please indicate the desired length;
Price and code of the upper model.

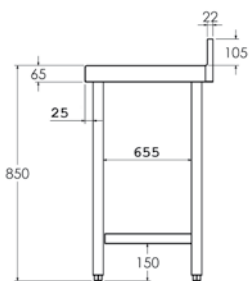

Wall-facing with 1 shelf

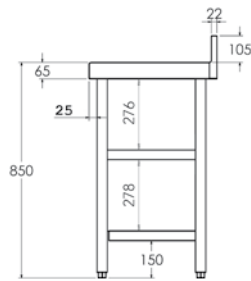

Wall-facing with 2 shelves



Total dimensions (mm)	Table with reinforcing frame	Table with 1 shelf	Table with 2 shelves	Table with doors
600 x 800 x 850	• FM080060	• FM181060	• FM280060	-
700 x 800 x 850	• FM080070	• FM181070	• FM280070	-
800 x 800 x 850	• FM080080	• FM180080	• FM280080	• FMP80080 SW
900 x 800 x 850	• FM080090	• FM180090	• FM280090	-
1000 x 800 x 850	• FM080100	• FM180100	• FM280100	• FMP80100 SL
1100 x 800 x 850	• FM080110	• FM180110	• FM280110	-
1200 x 800 x 850	• FM080120	• FM180120	• FM280120	• FMP80120 SL
1300 x 800 x 850	• FM080130	• FM180130	• FM280130	-
1400 x 800 x 850	• FM080140	• FM180140	• FM280140	• FMP80140 SL
1500 x 800 x 850	• FM080150	• FM180150	• FM280150	-
1600 x 800 x 850	• FM080160	• FM180160	• FM280160	• FMP80160 SL
1700 x 800 x 850	• FM080170	• FM180170	• FM280170	-
1800 x 800 x 850	• FM080180	• FM180180	• FM280180	• FMP80180 SL
1900 x 800 x 850	• FM080190	• FM180190	• FM280190	-
2000 x 800 x 850	• FM080200	• FM180200	• FM280200	• FMP80200 SL
2200 x 800 x 850	• FM080220	• FM180220	• FM280220	• FMP80220 SL
2400 x 800 x 850	• FM080240	• FM180240	• FM280240	• FMP80240 SL
2600 x 800 x 850	• FM080260	• FM180260	• FM280260	• FMP80260 SL
2800 x 800 x 850	• FM080280	• FM180280	• FM280280	• FMP80280 SL

• **SW** - Swinging Doors / **SL** - Sliding Doors

• **24-hour shipping**

• **3-day shipping**

WORK TABLES 900 Series

NEW

Center table

- AISI grade 304 brushed stainless steel (18/10) countertops with reinforcing omega brackets.
- Stainless steel shelf.
- 65 mm rounded edge, fully welded front panel.
- Tables with doors include: side and rear panels, with a middle shelf made of stainless steel.
- 40 x 40 mm square stainless steel legs allow you to raise the height of the unit from 850 to 900 mm.
- **Easy assembly in 3 minutes.**
- **Models with doors are shipped pre-assembled.**
- **Can be shipped fully assembled.**
- Up to 1200 mm: **MF001200**
- Up to 2000 mm: **MF002000**
- Up to 2800 mm: **MF002800**
- Optional door latches **OPC00001**



- **Customizable length available:**
Please indicate the desired length;
Price and code of the upper model.

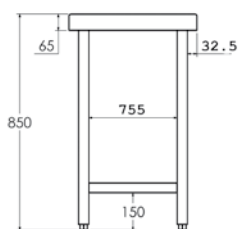

Center with 1 shelf

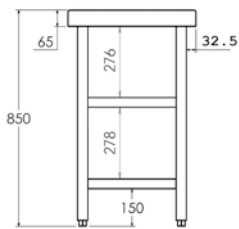

Center with 2 shelves



Total dimensions (mm)	Table with reinforcing frame	Table with 1 shelf	Table with 2 shelves	Table with doors	Table with pass-through sliding doors
600 x 900 x 850	• FC090060	• FC190060	• FC290060	-	-
700 x 900 x 850	• FC090070	• FC190070	• FC290070	-	-
800 x 900 x 850	• FC090080	• FC190080	• FC290080	• FCP90080 SW	-
900 x 900 x 850	• FC090090	• FC190090	• FC290090	-	-
1000 x 900 x 850	• FC090100	• FC190100	• FC290100	• FCP90100 SL	• FCPP9100
1100 x 900 x 850	• FC090110	• FC190110	• FC290110	-	-
1200 x 900 x 850	• FC090120	• FC190120	• FC290120	• FCP90120 SL	• FCPP9120
1300 x 900 x 850	• FC090130	• FC190130	• FC290130	-	-
1400 x 900 x 850	• FC090140	• FC190140	• FC290140	• FCP90140 SL	• FCPP9140
1500 x 900 x 850	• FC090150	• FC190150	• FC290150	-	-
1600 x 900 x 850	• FC090160	• FC190160	• FC290160	• FCP90160 SL	• FCPP9160
1700 x 900 x 850	• FC090170	• FC190170	• FC290170	-	-
1800 x 900 x 850	• FC090180	• FC190180	• FC290180	• FCP90180 SL	• FCPP9180
1900 x 900 x 850	• FC090190	• FC190190	• FC290190	-	-
2000 x 900 x 850	• FC090200	• FC190200	• FC290200	• FCP90200 SL	• FCPP9200
2200 x 900 x 850	• FC090220	• FC190220	• FC290220	• FCP90220 SL	• FCPP9220
2400 x 900 x 850	• FC090240	• FC190240	• FC290240	• FCP90240 SL	• FCPP9240
2600 x 900 x 850	• FC090260	• FC190260	• FC290260	• FCP90260 SL	• FCPP9260
2800 x 900 x 850	• FC090280	• FC190280	• FC290280	• FCP90280 SL	• FCPP9280

• **SW** - Swinging Doors / **SL** - Sliding Doors

• **24-hour shipping** • **3-day shipping**

900 Series

Wall-facing table

- AISI grade 304 brushed stainless steel (18/10) countertops with reinforcing omega brackets.
- Stainless steel shelf.
- 105 mm backsplash and 65 mm front panel with rounded safety edges, fully welded.
- Tables with doors include: side and rear panels, with a middle shelf made of stainless steel.
- 40 x 40 mm square stainless steel legs allow you to raise the height of the unit from 850 to 900 mm.
- **Easy assembly in 3 minutes.**
- **Models with doors are shipped pre-assembled.**
- **Can be shipped fully assembled.**
- Up to 1200 mm: **MF001200**
- Up to 2000 mm: **MF002000**
- Up to 2800 mm: **MF002800**
- Optional door latches **OPC00001**

 • **Customizable length available:**
Please indicate the desired length;
Price and code of the upper model.

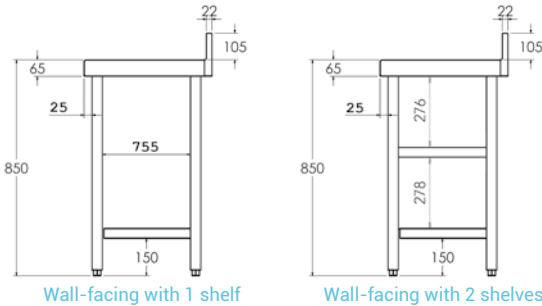

Wall-facing with 1 shelf

Wall-facing with 2 shelves



Total dimensions (mm)	Table with reinforcing frame	Table with 1 shelf	Table with 2 shelves	Table with doors
600 x 900 x 850	• FM090060	• FM190060	• FM290060	-
700 x 900 x 850	• FM090070	• FM190070	• FM290070	-
800 x 900 x 850	• FM090080	• FM190080	• FM290080	• FMP90080 SW
900 x 900 x 850	• FM090090	• FM190090	• FM290090	-
1000 x 900 x 850	• FM090100	• FM190100	• FM290100	• FMP90100 SL
1100 x 900 x 850	• FM090110	• FM190110	• FM290110	-
1200 x 900 x 850	• FM090120	• FM190120	• FM290120	• FMP90120 SL
1300 x 900 x 850	• FM090130	• FM190130	• FM290130	-
1400 x 900 x 850	• FM090140	• FM190140	• FM290140	• FMP90140 SL
1500 x 900 x 850	• FM090150	• FM190150	• FM290150	-
1600 x 900 x 850	• FM090160	• FM190160	• FM290160	• FMP90160 SL
1700 x 900 x 850	• FM090170	• FM190170	• FM290170	-
1800 x 900 x 850	• FM090180	• FM190180	• FM290180	• FMP90180 SL
1900 x 900 x 850	• FM090190	• FM190190	• FM290190	-
2000 x 900 x 850	• FM090200	• FM190200	• FM290200	• FMP90200 SL
2200 x 900 x 850	• FM090220	• FM190220	• FM290220	• FMP90220 SL
2400 x 900 x 850	• FM090240	• FM190240	• FM290240	• FMP90240 SL
2600 x 900 x 850	• FM090260	• FM190260	• FM290260	• FMP90260 SL
2800 x 900 x 850	• FM090280	• FM190280	• FM290280	• FMP90280 SL

• **SW** - Swinging Doors / **SL** - Sliding Doors

• **24-hour shipping**

• **3-day shipping**

WORK TABLES

Tables with doors and drawers

600/700 Series

NEW

Center tables with doors and drawers

- Made of AISI 304 stainless steel (18/10).
- Countertops and shelves have reinforcing omega brackets.
- 65 mm rounded edge, fully welded front panel.
- Shelf with very sturdy supports.
- 40 x 40 mm square stainless steel legs allow you to raise the height of the unit from 850 to 900 mm.
- Suspended sliding doors glide very smoothly. This design does not use bottom runners, facilitating cleaning.
- Module with 3 drawers included.
- Drawers have 290 x 435 x 109 mm of useful space.
- **No assembly required.**
- **Optional door latches OPC00001**



- **Customizable length available:**
Please indicate the desired length;
Price and code of the upper model.



600 Series

Total dimensions (mm)	Sliding doors and right-side drawers	Sliding doors and left-side drawers
1400 x 600 x 850	• FCPBD614	• FCPBI614
1600 x 600 x 850	• FCPBD616	• FCPBI616
1800 x 600 x 850	• FCPBD618	• FCPBI618
2000 x 600 x 850	• FCPBD620	• FCPBI620
2200 x 600 x 850	• FCPBD622	• FCPBI622
2400 x 600 x 850	• FCPBD624	• FCPBI624

700 Series

Total dimensions (mm)	Sliding doors and right-side drawers	Sliding doors and left-side drawers
1400 x 700 x 850	• FCPBD714	• FCPBI714
1600 x 700 x 850	• FCPBD716	• FCPBI716
1800 x 700 x 850	• FCPBD718	• FCPBI718
2000 x 700 x 850	• FCPBD720	• FCPBI720
2200 x 700 x 850	• FCPBD722	• FCPBI722
2400 x 700 x 850	• FCPBD724	• FCPBI724

• 24-hour shipping

• 3-day shipping

600/700 Series

Wall-facing tables with doors and drawers

- Made of AISI 304 stainless steel (18/10).
- Countertops and shelves have reinforcing omega brackets.
- 105 mm backsplash and 65 mm front panel with rounded safety edges, fully welded.
- Shelf with very sturdy supports.
- 40 x 40 mm square stainless steel legs allow you to raise the height of the unit from 850 to 900 mm.
- Suspended sliding doors glide very smoothly. This design does not use bottom runners, facilitating cleaning.
- Module with 3 drawers included.
- Drawers have 290 x 435 x 109 mm of useful space.
- **No assembly required.**
- **Optional door latches OPC00001**



- **Customizable length available:**
Please indicate the desired length;
Price and code of the upper model.



600 Series

Total dimensions (mm)	Sliding doors and right-side drawers	Sliding doors and left-side drawers
1400 x 600 x 850	• FMPBD614	• FMPBI614
1600 x 600 x 850	• FMPBD616	• FMPBI616
1800 x 600 x 850	• FMPBD618	• FMPBI618
2000 x 600 x 850	• FMPBD620	• FMPBI620
2200 x 600 x 850	• FMPBD622	• FMPBI622
2400 x 600 x 850	• FMPBD624	• FMPBI624

700 Series

Total dimensions (mm)	Sliding doors and right-side drawers	Sliding doors and left-side drawers
1400 x 700 x 850	• FMPBD714	• FMPBI714
1600 x 700 x 850	• FMPBD716	• FMPBI716
1800 x 700 x 850	• FMPBD718	• FMPBI718
2000 x 700 x 850	• FMPBD720	• FMPBI720
2200 x 700 x 850	• FMPBD722	• FMPBI722
2400 x 700 x 850	• FMPBD724	• FMPBI724

• 24-hour shipping

• 3-day shipping

WORK TABLES

With basin

600/700 Series

NEW

Wall-facing table with basin and reinforced frame

- Built with AISI grade 304 stainless steel (18/10) countertops.
- Reinforcing omega brackets are provided to offer better support.
- 105mm backsplash and 65mm front panel with rounded safety edges, fully welded.
- 500 x 400 x 250 mm welded basin.
- 40 x 40 mm square stainless steel legs allow you to raise the height of the unit from 850 to 900 mm.
- **Easy assembly in 3 minutes.**
- **Can be shipped fully assembled.**
 Up to 1200 mm: **MF001200**
 Up to 2000 mm: **MF002000**
 Up to 2800 mm: **MF002800**



- **Customizable length available:**
 Please indicate the desired length;
 Price and code of the upper model.

 Taps page 33



600 Series

Total dimensions (mm)	Right basin	Left basin	Center basin
1000 x 600 x 850	• FCDR6010	• FCIR6010	-
1200 x 600 x 850	• FCDR6012	• FCIR6012	-
1400 x 600 x 850	• FCDR6014	• FCIR6014	-
1500 x 600 x 850	• FCDR6015	• FCIR6015	• FCCR6015
1600 x 600 x 850	• FCDR6016	• FCIR6016	• FCCR6016
1800 x 600 x 850	• FCDR6018	• FCIR6018	• FCCR6018
2000 x 600 x 850	• FCDR6020	• FCIR6020	• FCCR6020
2200 x 600 x 850	• FCDR6022	• FCIR6022	-
2400 x 600 x 850	• FCDR6024	• FCIR6024	-
2600 x 600 x 850	• FCDR6026	• FCIR6026	-
2800 x 600 x 850	• FCDR6028	• FCIR6028	-

700 Series

Total dimensions (mm)	Right basin	Left basin	Center basin
1000 x 700 x 850	• FCDR7010	• FCIR7010	-
1200 x 700 x 850	• FCDR7012	• FCIR7012	-
1400 x 700 x 850	• FCDR7014	• FCIR7014	-
1500 x 700 x 850	• FCDR7015	• FCIR7015	• FCCR7015
1600 x 700 x 850	• FCDR7016	• FCIR7016	• FCCR7016
1800 x 700 x 850	• FCDR7018	• FCIR7018	• FCCR7018
2000 x 700 x 850	• FCDR7020	• FCIR7020	• FCCR7020
2200 x 700 x 850	• FCDR7022	• FCIR7022	-
2400 x 700 x 850	• FCDR7024	• FCIR7024	-
2600 x 700 x 850	• FCDR7026	• FCIR7026	-
2800 x 700 x 850	• FCDR7028	• FCIR7028	-

• 24-hour shipping • 3-day shipping

600/700 Series

Wall-facing table with basin and shelf

- Built with AISI grade 304 stainless steel (18/10) countertops.
- Reinforcing omega brackets are provided to offer better support.
- 105 mm backsplash and 65 mm front panel with rounded safety edges, fully welded.
- Stainless steel shelf.
- 500 x 400 x 250 mm welded basin.
- 40 x 40 mm square stainless steel legs allow you to raise the height of the unit from 850 to 900 mm.

- **Easy assembly in 3 minutes.**
- **Can be shipped fully assembled.**

Up to 1200 mm: **MF001200**

Up to 2000 mm: **MF002000**

Up to 2800 mm: **MF002800**



- **Customizable length available:**

Please indicate the desired length;
Price and code of the upper model.



Taps page 33



600 Series

Total dimensions (mm)	Right basin	Left basin	Center basin
1000 x 600 x 850	• FCDE6010	• FCIE6010	-
1200 x 600 x 850	• FCDE6012	• FCIE6012	-
1400 x 600 x 850	• FCDE6014	• FCIE6014	-
1500 x 600 x 850	• FCDE6015	• FCIE6015	• FCCE6015
1600 x 600 x 850	• FCDE6016	• FCIE6016	• FCCE6016
1800 x 600 x 850	• FCDE6018	• FCIE6018	• FCCE6018
2000 x 600 x 850	• FCDE6020	• FCIE6020	• FCCE6020
2200 x 600 x 850	• FCDE6022	• FCIE6022	-
2400 x 600 x 850	• FCDE6024	• FCIE6024	-
2600 x 600 x 850	• FCDE6026	• FCIE6026	-
2800 x 600 x 850	• FCDE6028	• FCIE6028	-

700 Series

Total dimensions (mm)	Right basin	Left basin	Center basin
1000 x 700 x 850	• FCDE7010	• FCIE7010	-
1200 x 700 x 850	• FCDE7012	• FCIE7012	-
1400 x 700 x 850	• FCDE7014	• FCIE7014	-
1500 x 700 x 850	• FCDE7015	• FCIE7015	• FCCE7015
1600 x 700 x 850	• FCDE7016	• FCIE7016	• FCCE7016
1800 x 700 x 850	• FCDE7018	• FCIE7018	• FCCE7018
2000 x 700 x 850	• FCDE7020	• FCIE7020	• FCCE7020
2200 x 700 x 850	• FCDE7022	• FCIE7022	-
2400 x 700 x 850	• FCDE7024	• FCIE7024	-
2600 x 700 x 850	• FCDE7026	• FCIE7026	-
2800 x 700 x 850	• FCDE7028	• FCIE7028	-

• 24-hour shipping

• 3-day shipping

WORK TABLES

With no-drip edge and basin

600/700 Series

Wall-facing table with no-drip edge, basin, and reinforced frame

- Built with AISI grade 304 brushed stainless steel (18/10) countertops.
- No-drip edge
- Reinforcing omega brackets are provided to offer better support.
- 105 mm backsplash and 65 mm front panel with rounded safety edges, fully welded.
- 500 x 400 x 250 mm welded basin.
- 40 x 40 mm square stainless steel legs allow you to raise the height of the unit from 850 to 900 mm.
- **Easy assembly in 3 minutes.**
- **Can be shipped fully assembled.**
- Up to 1200 mm: **MF001200**
- Up to 2000 mm: **MF002000**
- Up to 2800 mm: **MF002800**



 Taps page 33

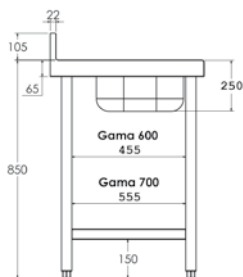

600 Series

Total dimensions (mm)	Right basin	Left basin	Center basin
1000 x 600 x 850	• FCDRS610	• FCIRS610	-
1200 x 600 x 850	• FCDRS612	• FCIRS612	-
1400 x 600 x 850	• FCDRS614	• FCIRS614	-
1600 x 600 x 850	• FCDRS616	• FCIRS616	• FCCRS616
1800 x 600 x 850	• FCDRS618	• FCIRS618	• FCCRS618
2000 x 600 x 850	• FCDRS620	• FCIRS620	• FCCRS620

700 Series

Total dimensions (mm)	Right basin	Left basin	Center basin
1000 x 700 x 850	• FCDRS710	• FCIRS710	-
1200 x 700 x 850	• FCDRS712	• FCIRS712	-
1400 x 700 x 850	• FCDRS714	• FCIRS714	-
1600 x 700 x 850	• FCDRS716	• FCIRS716	• FCCRS716
1800 x 700 x 850	• FCDRS718	• FCIRS718	• FCCRS718
2000 x 700 x 850	• FCDRS720	• FCIRS720	• FCCRS720

• 3-day shipping

600/700 Series

Wall-facing table with no-drip edge, basin, and shelf

- Built with AISI grade 304 brushed stainless steel (18/10) countertops.
- No-drip edge
- Reinforcing omega brackets are provided to offer better support.
- 105 mm backsplash and 65 mm front panel with rounded safety edges, fully welded.
- Stainless steel shelf.
- 500 x 400 x 250 mm welded basin.
- 40 x 40 mm square stainless steel legs allow you to raise the height of the unit from 850 to 900 mm.
- **Easy assembly in 3 minutes.**
- **Can be shipped fully assembled.**
- Up to 1200 mm: **MF001200**
- Up to 2000 mm: **MF002000**
- Up to 2800 mm: **MF002800**



 Taps page 33

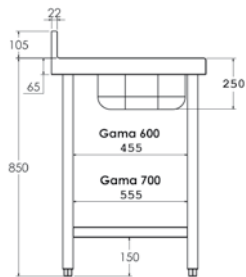

600 Series

Total dimensions (mm)	Right basin	Left basin	Center basin
1000 x 600 x 850	• FCDES610	• FCIES610	-
1200 x 600 x 850	• FCDES612	• FCIES612	-
1400 x 600 x 850	• FCDES614	• FCIES614	-
1600 x 600 x 850	• FCDES616	• FCIES616	• FCCES616
1800 x 600 x 850	• FCDES618	• FCIES618	• FCCES618
2000 x 600 x 850	• FCDES620	• FCIES620	• FCCES620

700 Series

Total dimensions (mm)	Right basin	Left basin	Center basin
1000 x 700 x 850	• FCDES710	• FCIES710	-
1200 x 700 x 850	• FCDES712	• FCIES712	-
1400 x 700 x 850	• FCDES714	• FCIES714	-
1600 x 700 x 850	• FCDES716	• FCIES716	• FCCES716
1800 x 700 x 850	• FCDES718	• FCIES718	• FCCES718
2000 x 700 x 850	• FCDES720	• FCIES720	• FCCES720

• 3-day shipping

WORK TABLES

With basin and doors

600/700 Series

Wall-facing table with basin and sliding doors

- Built with AISI grade 304 brushed stainless steel (18/10) countertops.
- Reinforcing omega brackets are provided to offer better support.
- 105 mm backsplash and 65 mm front panel with rounded safety edges, fully welded.
- 500 x 400 x 250 mm welded basin.
- Suspended sliding doors glide very smoothly. This design does not use bottom runners, facilitating cleaning.
- 40 x 40 mm square stainless steel legs allow you to raise the height of the unit from 850 to 900 mm.
- Open rear section to facilitate access to installations.
- **No assembly required.**
- **Optional door latches OPC0001**



• **Customizable length available:**
Please indicate the desired length;
Price and code of the upper model.

 Taps page 33



600 Series

Total dimensions (mm)	Right basin	Left basin	Center basin
1000 x 600 x 850	• FPCD6010	• FPCI6010	-
1200 x 600 x 850	• FPCD6012	• FPCI6012	-
1400 x 600 x 850	• FPCD6014	• FPCI6014	-
1600 x 600 x 850	• FPCD6016	• FPCI6016	• FPCC6016
1800 x 600 x 850	• FPCD6018	• FPCI6018	• FPCC6018
2000 x 600 x 850	• FPCD6020	• FPCI6020	• FPCC6020
2200 x 600 x 850	• FPCD6022	• FPCI6022	-
2400 x 600 x 850	• FPCD6024	• FPCI6024	-
2600 x 600 x 850	• FPCD6026	• FPCI6026	-
2800 x 600 x 850	• FPCD6028	• FPCI6028	-

700 Series

Total dimensions (mm)	Right basin	Left basin	Center basin
1000 x 700 x 850	• FPCD7010	• FPCI7010	-
1200 x 700 x 850	• FPCD7012	• FPCI7012	-
1400 x 700 x 850	• FPCD7014	• FPCI7014	-
1600 x 700 x 850	• FPCD7016	• FPCI7016	• FPCC7016
1800 x 700 x 850	• FPCD7018	• FPCI7018	• FPCC7018
2000 x 700 x 850	• FPCD7020	• FPCI7020	• FPCC7020
2200 x 700 x 850	• FPCD7022	• FPCI7022	-
2400 x 700 x 850	• FPCD7024	• FPCI7024	-
2600 x 700 x 850	• FPCD7026	• FPCI7026	-
2800 x 700 x 850	• FPCD7028	• FPCI7028	-

• 24-hour shipping

• 3-day shipping

WORK TABLES

Tables with basin, doors, and drawers

600/700 Series

NEW

Wall-facing table with basin, sliding doors, and drawers

- Built with AISI grade 304 brushed stainless steel (18/10) countertops.
- Reinforcing omega brackets are provided to offer better support.
- 105 mm backsplash and 65 mm front panel with rounded safety edges, fully welded.
- 500 x 400 x 250 mm welded basin.
- Suspended sliding doors glide very smoothly. This design does not use bottom runners, facilitating cleaning.
- 40 x 40 mm square stainless steel legs allow you to raise the height of the unit from 850 to 900 mm.
- Module with 3 drawers included.
- Drawers have 290 x 435 x 109 mm of useful space.
- Open rear section to facilitate access to installations.
- **No assembly required.**
- **Optional door latches OPC00001**



- **Customizable length available:**
Please indicate the desired length;
Price and code of the upper model.

 Taps page 33



600 Series

Total dimensions (mm)	Right basin	Left basin
1400 x 600 x 850	• FCDPB614	• FCIPB614
1600 x 600 x 850	• FCDPB616	• FCIPB616
1800 x 600 x 850	• FCDPB618	• FCIPB618
2000 x 600 x 850	• FCDPB620	• FCIPB620
2200 x 600 x 850	• FCDPB622	• FCIPB622
2400 x 600 x 850	• FCDPB624	• FCIPB624

700 Series

Total dimensions (mm)	Right basin	Left basin
1400 x 700 x 850	• FCDPB714	• FCIPB714
1600 x 700 x 850	• FCDPB716	• FCIPB716
1800 x 700 x 850	• FCDPB718	• FCIPB718
2000 x 700 x 850	• FCDPB720	• FCIPB720
2200 x 700 x 850	• FCDPB722	• FCIPB722
2400 x 700 x 850	• FCDPB724	• FCIPB724

• 24-hour shipping

• 3-day shipping

WORK TABLES

Center and Wall-facing countertop

600/700 Series

NEW

Countertop

- Built with AISI grade 304 brushed stainless steel (18/10).
- With reinforcing omega brackets.
- 105 mm backsplash and 65 mm front panel with rounded safety edges, fully welded.



• **Customizable length available:**
Please indicate the desired length;
Price and code of the upper model.



600 Series

Total dimensions (mm)	Center countertop	Wall-facing countertop
400 x 600	• F0080301	• F0080351
500 x 600	• F0080302	• F0080352
600 x 600	• F0080303	• F0080353
700 x 600	• F0080419	• F0080420
800 x 600	• F0080304	• F0080354
900 x 600	• F0080401	• F0080403
1000 x 600	• F0080305	• F0080355
1100 x 600	• F0080306	• F0080356
1200 x 600	• F0080307	• F0080357
1300 x 600	• F0080308	• F0080358
1400 x 600	• F0080309	• F0080359
1500 x 600	• F0080310	• F0080360
1600 x 600	• F0080311	• F0080361
1700 x 600	• F0080312	• F0080362
1800 x 600	• F0080313	• F0080363
1900 x 600	• F0080314	• F0080364
2000 x 600	• F0080315	• F0080365
2100 x 600	• F0080316	• F0080366
2200 x 600	• F0080317	• F0080367
2300 x 600	• F0080318	• F0080368
2400 x 600	• F0080319	• F0080369
2500 x 600	• F0080320	• F0080370
2600 x 600	• F0080321	• F0080371
2700 x 600	• F0080322	• F0080372
2800 x 600	• F0080323	• F0080373



700 Series

Total dimensions (mm)	Center countertop	Wall-facing countertop
400 x 700	• F0080326	• F0080376
500 x 700	• F0080327	• F0080377
600 x 700	• F0080328	• F0080378
700 x 700	• F0080421	• F0080422
800 x 700	• F0080329	• F0080379
900 x 700	• F0080402	• F0080404
1000 x 700	• F0080330	• F0080380
1100 x 700	• F0080331	• F0080381
1200 x 700	• F0080332	• F0080382
1300 x 700	• F0080333	• F0080383
1400 x 700	• F0080334	• F0080384
1500 x 700	• F0080335	• F0080385
1600 x 700	• F0080336	• F0080386
1700 x 700	• F0080337	• F0080387
1800 x 700	• F0080338	• F0080388
1900 x 700	• F0080339	• F0080389
2000 x 700	• F0080340	• F0080390
2100 x 700	• F0080341	• F0080391
2200 x 700	• F0080342	• F0080392
2300 x 700	• F0080343	• F0080393
2400 x 700	• F0080344	• F0080394
2500 x 700	• F0080345	• F0080395
2600 x 700	• F0080346	• F0080396
2700 x 700	• F0080347	• F0080397
2800 x 700	• F0080348	• F0080398

• 24-hour shipping

• 3-day shipping

WORK TABLES

NEW

Wall-facing countertop with basin 600/700 Series

Countertop with basin

- Built with AISI grade 304 brushed stainless steel (18/10).
- With reinforcing omega brackets.
- 105 mm backplash and 65 mm front panel with rounded safety edges, fully welded.
- 500 x 400 x 250 mm welded basin.



- **Customizable length available:**
Please indicate the desired length;
Price and code of the upper model.

 Taps page 33



600 Series

Total dimensions (mm)	Countertop with right basin	Countertop with left basin	Countertop with center basin
1000 x 600	• FEC1006D	• FEC1006I	• FEC1006C
1200 x 600	• FEC1206D	• FEC1206I	• FEC1206C
1400 x 600	• FEC1406D	• FEC1406I	• FEC1406C
1500 x 600	• FEC1506D	• FEC1506I	• FEC1506C
1600 x 600	• FEC1606D	• FEC1606I	• FEC1606C
1800 x 600	• FEC1806D	• FEC1806I	• FEC1806C
2000 x 600	• FEC2006D	• FEC2006I	• FEC2006C
2200 x 600	• FEC2206D	• FEC2206I	• FEC2206C
2400 x 600	• FEC2406D	• FEC2406I	• FEC2406C
2600 x 600	• FEC2606D	• FEC2606I	• FEC2606C
2800 x 600	• FEC2806D	• FEC2806I	• FEC2806C

700 Series

Total dimensions (mm)	Countertop with right basin	Countertop with left basin	Countertop with center basin
1000 x 700	• FEC1007D	• FEC1007I	• FEC1007C
1200 x 700	• FEC1207D	• FEC1207I	• FEC1207C
1400 x 700	• FEC1407D	• FEC1407I	• FEC1407C
1500 x 700	• FEC1507D	• FEC1507I	• FEC1507C
1600 x 700	• FEC1607D	• FEC1607I	• FEC1607C
1800 x 700	• FEC1807D	• FEC1807I	• FEC1807C
2000 x 700	• FEC2007D	• FEC2007I	• FEC2007C
2200 x 700	• FEC2207D	• FEC2207I	• FEC2207C
2400 x 700	• FEC2407D	• FEC2407I	• FEC2407C
2600 x 700	• FEC2607D	• FEC2607I	• FEC2607C
2800 x 700	• FEC2807D	• FEC2807I	• FEC2807C

Countertop supports

- Made of AISI grade 304 stainless steel (18/10).
- For the 600 / 700 Series
- Price per unit.

Model	Code
Support with leg	• F0020309
Wall mount	• F0020310



• 24-hour shipping

• 3-day shipping

WORK TABLES

600-mm-high tables

600/700 Series

NEW

- **Designed to support cooking appliances at a working height of 850-900 mm.**
- Countertop made of AISI 304 brushed stainless steel (18/10).
- Countertops and shelves have reinforcing omega brackets.
- Stainless steel shelf.
- 105 mm backsplash (wall-facing models) and 65 mm front panel with rounded safety edges, fully welded.
- 40 x 40 mm square stainless steel legs allow you to raise the height of the unit from 600 to 650 mm.
- **Easy assembly in 3 minutes.**
- **Can be shipped fully assembled.**
 Up to 1200 mm: **MF001200**
 Up to 2000 mm: **MF002000**
 Up to 2800 mm: **MF002800**



- **Customizable length available:**
 Please indicate the desired length;
 Price and code of the upper model.



600 Series

Total dimensions (mm)	Center table		Wall-facing table	
	with frame for reinforcement	With 1 shelf	with frame for reinforcement	With 1 shelf
600 x 600 x 600	• FC066060	• FC166060	• FM066060	• FM166060
700 x 600 x 600	• FC066070	• FC166070	• FM066070	• FM166070
800 x 600 x 600	• FC066080	• FC166080	• FM066080	• FM166080
900 x 600 x 600	• FC066090	• FC166090	• FM066090	• FM166090
1000 x 600 x 600	• FC066100	• FC166100	• FM066100	• FM166100
1100 x 600 x 600	• FC066110	• FC166110	• FM066110	• FM166110
1200 x 600 x 600	• FC066120	• FC166120	• FM066120	• FM166120
1300 x 600 x 600	• FC066130	• FC166130	• FM066130	• FM166130
1400 x 600 x 600	• FC066140	• FC166140	• FM066140	• FM166140
1500 x 600 x 600	• FC066150	• FC166150	• FM066150	• FM166150
1600 x 600 x 600	• FC066160	• FC166160	• FM066160	• FM166160
1700 x 600 x 600	• FC066170	• FC166170	• FM066170	• FM166170
1800 x 600 x 600	• FC066180	• FC166180	• FM066180	• FM166180
1900 x 600 x 600	• FC066190	• FC166190	• FM066190	• FM166190
2000 x 600 x 600	• FC066200	• FC166200	• FM066200	• FM166200
2200 x 600 x 600	• FC066220	• FC166220	• FM066220	• FM166220
2400 x 600 x 600	• FC066240	• FC166240	• FM066240	• FM166240
2600 x 600 x 600	• FC066260	• FC166260	• FM066260	• FM166260
2800 x 600 x 600	• FC066280	• FC166280	• FM066280	• FM166280

• 24-hour shipping • 3-day shipping

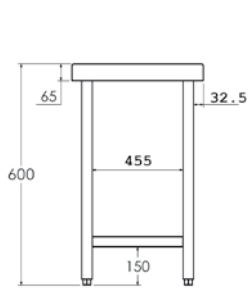

600 series center table

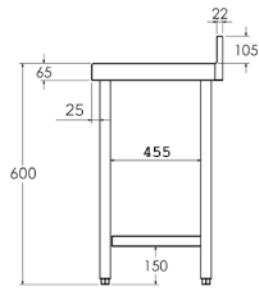

600 series wall-facing table

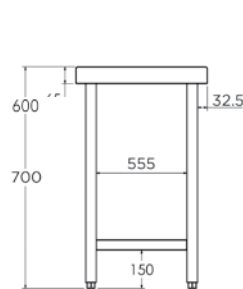

700 series center table

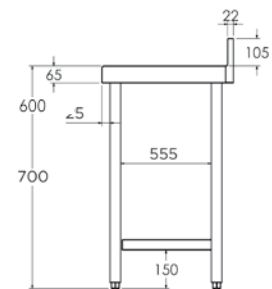

700 series wall-facing table



700 Series

Center table

Wall-facing table

Total dimensions (mm)	Center table		Wall-facing table	
	with frame for reinforcement	With 1 shelf	with frame for reinforcement	With 1 shelf
600 x 700 x 600	• FC067060	• FC167060	• FM067060	• FM167060
700 x 700 x 600	• FC067070	• FC167070	• FM067070	• FM167070
800 x 700 x 600	• FC067080	• FC167080	• FM067080	• FM167080
900 x 700 x 600	• FC067090	• FC167090	• FM067090	• FM167090
1000 x 700 x 600	• FC067100	• FC167100	• FM067100	• FM167100
1100 x 700 x 600	• FC067110	• FC167110	• FM067110	• FM167110
1200 x 700 x 600	• FC067120	• FC167120	• FM067120	• FM167120
1300 x 700 x 600	• FC067130	• FC167130	• FM067130	• FM167130
1400 x 700 x 600	• FC067140	• FC167140	• FM067140	• FM167140
1500 x 700 x 600	• FC067150	• FC167150	• FM067150	• FM167150
1600 x 700 x 600	• FC067160	• FC167160	• FM067160	• FM167160
1700 x 700 x 600	• FC067170	• FC167170	• FM067170	• FM167170
1800 x 700 x 600	• FC067180	• FC167180	• FM067180	• FM167180
1900 x 700 x 600	• FC067190	• FC167190	• FM067190	• FM167190
2000 x 700 x 600	• FC067200	• FC167200	• FM067200	• FM167200
2200 x 700 x 600	• FC067220	• FC167220	• FM067220	• FM167220
2400 x 700 x 600	• FC067240	• FC167240	• FM067240	• FM167240
2600 x 700 x 600	• FC067260	• FC167260	• FM067260	• FM167260
2800 x 700 x 600	• FC067280	• FC167280	• FM067280	• FM167280

Pack of 4 or 6 castors for 600-mm-high tables

- 40 x 40 mm square legs are included.
- Includes four or six Ø125 mm castors (two with brakes).



Model	For long tables	Code
4 castors	≤ 2000 mm	• F0026312
6 castors	> 2000 mm	• F0026325

• 24-hour shipping

• 3-day shipping

WORK TABLES

NEW

For waste, tables with drawers, and corner tables

Wall-facing table with door and waste chute

- Made of AISI 304 stainless steel (18/10).
- Countertop waste chute with rubber ring for throwing trash directly into a bin beneath the counter.
- 40 x 40 mm square stainless steel legs allow you to raise the height of the unit from 850 to 900 mm.
- Waste containers of up to Ø 500 mm for 50l bags.
- **No assembly required.**
- **Waste container not included.**

Total dimensions (mm)	Code
700 x 600 x 850	• FMPA7060
700 x 700 x 850	• FMPA7070



Waste containers page 143

Wall-facing table with drawers

- Made of AISI 304 stainless steel (18/10).
- 40 x 40 mm square stainless steel legs allow you to raise the height of the unit from 850 to 900 mm.
- Drawers measure 290 x 435 x 110 mm of useful space.
- **No assembly required.**

Total dimensions (mm)	Drawers	Code
500 x 600 x 850	3	• FMB50600
500 x 700 x 850	3	• FMB50700



Corner tables

- Countertop made of AISI 304 stainless steel (18/10).
- Stainless steel shelves have reinforcing omega brackets.
- 105 mm backsplash and 65 mm front panel with rounded safety edges, fully welded.
- 40 x 40 mm stainless steel square legs allow you to raise the height of the unit from 850 to 900 mm.
- **Easy assembly in 3 minutes.**
- **Can be shipped fully assembled.**
- Up to 1200 mm: **MF001200**

Total dimensions (mm)	Table with 1 shelf	Table with 2 shelves
A B		
600 x 600	• FMA60600	• FMA26060
700 x 700	• FMA70700	• FMA27070
600 x 700	• FMA60700	• FMA26070
700 x 600	• FMA70600	• FMA27060



Corner table with door

- Made of AISI 304 stainless steel (18/10).
- 105 mm backsplash and 65 mm front panel with rounded safety edges, fully welded.
- Fully welded structure.
- 40 x 40 mm square stainless steel legs allow you to raise the height of the unit from 850 to 900 mm.
- **No assembly required.**

Model	Total dimensions (mm)	Code
600 Series	1000 x 1000 x 600 x 850	• FA601010
700 Series	1000 x 1000 x 700 x 850	• FA701010



• 24-hour shipping

• 3-day shipping

WORK TABLES

Accessories

NEW

Countertop shelves

- To illuminate and maintain the temperature of recently cooked dishes before serving.
 - Shelves made of AISI grade 304 stainless steel (18/10).
 - Supports made of round Ø30 mm tubes.
 - Single or Double models with 3 options: neutral, halogen light and heat, and infrared heat with ceramic.
 - Easy installation by making small holes in the worktop with joining support.
 - Lighted switch on the screens.
 - **Easy assembly in 3 minutes.**
 - **Can be shipped fully assembled.**
- Up to 1200 mm: **MF001200**
 Up to 2000 mm: **MF002000**
 Up to 2800 mm: **MF002800**

-  • **Customizable length available:**
 Please indicate the desired length;
 Price and code of the upper model.

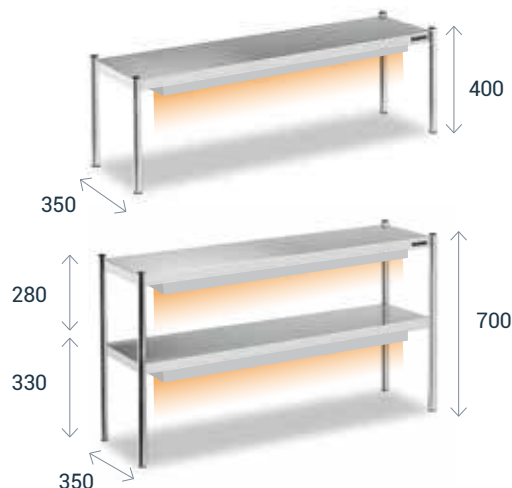

Single

For table workspace	Total dimensions (mm)	Neutral	Light and heat Halogen	Power (W)	Infrared heat Ceramic	Power (W)
1000 Long	700 x 350 x 400	• F0030001	-	-	-	-
1200 Long	900 x 350 x 400	• F0030008	• FCH30008	600	• FCC30008	500
1400 Long	1100 x 350 x 400	• F0030002	• FCH30002	600	• FCC30002	500
1600 Long	1300 x 350 x 400	• F0030003	• FCH30003	900	• FCC30003	750
1800 Long	1500 x 350 x 400	• F0030004	• FCH30004	900	• FCC30004	750
2000 Long	1700 x 350 x 400	• F0030005	• FCH30005	1200	• FCC30005	1000
2200 Long	1900 x 350 x 400	• F0030009	• FCH30009	1200	• FCC30009	1000
2400 Long	2100 x 350 x 400	• F0030010	• FCH30010	1500	• FCC30010	1250
2600 Long	2300 x 350 x 400	• F0030011	• FCH30011	1800	• FCC30011	1500
2800 Long	2500 x 350 x 400	• F0030012	• FCH30012	1800	• FCC30012	1500

Double

For table workspace	Total dimensions (mm)	Neutral	Light and heat Halogen	Power (W)	Infrared heat Ceramic	Power (W)
1000 Long	700 x 350 x 700	• F0030101	-	-	-	-
1200 Long	900 x 350 x 700	• F0030108	• FCH40008	1200	• FCC40008	1000
1400 Long	1100 x 350 x 700	• F0030102	• FCH40002	1200	• FCC40002	1000
1600 Long	1300 x 350 x 700	• F0030103	• FCH40003	1800	• FCC40003	1500
1800 Long	1500 x 350 x 700	• F0030104	• FCH40004	1800	• FCC40004	1500
2000 Long	1700 x 350 x 700	• F0030105	• FCH40005	2400	• FCC40005	2000
2200 Long	1900 x 350 x 700	• F0030109	• FCH40009	2400	• FCC40009	2000
2400 Long	2100 x 350 x 700	• F0030110	• FCH40010	3000	• FCC40010	2500
2600 Long	2300 x 350 x 700	• F0030111	• FCH40011	3600	• FCC40011	3000
2800 Long	2500 x 350 x 700	• F0030112	• FCH40012	3600	• FCC40012	3000

Halogen strip heater

- **Designed to fit under countertop shelving (not included).**
- Halogen light and heat unit with R7s-15 bulbs and additional glass protection.
- Unit with infrared heating system featuring long-lasting ceramic components.
- Made of stainless steel.
- It has a light-up switch.
- Easy to mount on the shelf - no tools required.



Total dimensions (mm)	Lamps	Voltage (V/Hz)	Halogen light and heat	Power (W)	Infrared heat Ceramic	Power (W)
800 x 150 x 60	2	230/50	• F1020601	600	• F1040601	500
1200 x 150 x 60	3	230/50	• F1020602	900	• F1040602	750
1600 x 150 x 60	4	230/50	• F1020603	1200	• F1040603	1000
2000 x 150 x 60	5	230/50	• F1020604	1500	• F1040604	1250

• **24-hour shipping**

• **3-day shipping**

WORK TABLES Accessories

Drawer with telescopic runners

- Made of AISI grade 304 stainless steel (18/10).
- Installed on all work tables except 500 series.

Total dimensions (mm)	Code
460 x 450 x 150	• F0020302



Drawer module

- Made of AISI grade 304 stainless steel (18/10).
- Module is easy to install onto a table.
- Modules with 3 drawers: drawers have 290 x 435 x 109 mm of useful space each.
- Modules with 4 drawers: drawers have 290 x 435 x 62 mm of useful space each.
- Drawers with linear ball-bearings.

Model	Total dimensions (mm)	Drawers	Code
600 Series	400 x 510 x 590	3	• FB3C6040
	400 x 510 x 590	4	• FB4C6040
700 Series	400 x 610 x 590	3	• FB3C7040
	400 x 610 x 590	4	• FB4C7040



High capacity module with drawers

- **Can be used as a bread chute, for waste bags, etc.**
- Made of AISI grade 304 stainless steel (18/10).
- Includes a clamp for waste bags.
- Module is easy to install onto a table.
- Drawer opens on 4 runners.

Model	Total dimensions (mm)	Code
600 Series	465 x 510 x 590	• F0020340
700 Series	465 x 610 x 590	• F0020341



NEW

Runner set module for GN1/1 and Bakery

- Made of AISI grade 304 stainless steel (18/10).
- Module is easy to install onto a table.

Model	Total dimensions (mm)	Code
GN 1/1	380 x 530 x 560	• F0020332
Bakery	436 x 660 x 596	• F0020337



• 24-hour shipping

WORK TABLES

Accessories

NEW

Side and back panels for tables

- Ideal for protecting walkways and dividing storage areas.
- Made of stainless steel.
- Easy to install on tables.



Side panel

For model	Code
500 Series	• FPL00500
550 Series	• FPL00550
600 Series	• FPL00600
700 Series	• FPL00700
800 Series	• FPL00800
900 Series	• FPL00900

Rear



- Customizable length available: Please indicate the desired length; Price and code of the upper model.

Table length	Code
600	• FT050600
700	• FT050700
800	• FT050800
900	• FT050900
1000	• FT051000
1100	• FT051100

Table length	Code
1200	• FT051200
1300	• FT051300
1400	• FT051400
1500	• FT051500
1600	• FT051600
1700	• FT051700

Table length	Code
1800	• FT051800
1900	• FT051900
2000	• FT052000
2200	• FT052200
2400	• FT052400
2600	• FT052600

Additional shelf for table

- Made of AISI grade 304 stainless steel (18/10).
- Lower reinforcing omega brackets to increase load capacity.
- Easy to install on tables.

Table length	500 Series	550 Series	600 Series	700 Series	800 Series	900 Series
600	• FME50060	• FME55060	• FME60060	• FME70060	• FME80060	• FME90060
700	-	-	• FME60070	• FME70070	• FME80070	• FME90070
800	• FME50080	• FME55080	• FME60080	• FME70080	• FME80080	• FME90080
900	-	-	• FME60090	• FME70090	• FME80090	• FME90090
1000	• FME50100	• FME55100	• FME60100	• FME70100	• FME80100	• FME90100
1100	-	-	• FME60110	• FME70110	• FME80110	• FME90110
1200	• FME50120	• FME55120	• FME60120	• FME70120	• FME80120	• FME90120
1300	-	-	• FME60130	• FME70130	• FME80130	• FME90130
1400	• FME50140	• FME55140	• FME60140	• FME70140	• FME80140	• FME90140
1500	• FME50150	• FME55150	• FME60150	• FME70150	• FME80150	• FME90150
1600	• FME50160	• FME55160	• FME60160	• FME70160	• FME80160	• FME90160
1700	-	-	• FME60170	• FME70170	• FME80170	• FME90170
1800	• FME50180	• FME55180	• FME60180	• FME70180	• FME80180	• FME90180
1900	-	-	• FME60190	• FME70190	• FME80190	• FME90190
2000	• FME50200	• FME55200	• FME60200	• FME70200	• FME80200	• FME90200
2200	• FME50220	• FME55220	• FME60220	• FME70220	• FME80220	• FME90220
2400	• FME50240	• FME55240	• FME60240	• FME70240	• FME80240	• FME90240
2600	-	-	• FME60260	• FME70260	• FME80260	• FME90260
2800	-	-	• FME60280	• FME70280	• FME80280	• FME90280

• 24-hour shipping

• 3-day shipping

WORK TABLES

Accessories

Detachable side splash for work tables and standard countertops



- Made of AISI grade 304 stainless steel (18/10).
- Easy to install from the side.
- Only for wall-facing tables.



Model	Side	Code
500 Series	Right	• CPE00013
	Left	• CPE00014
550 Series	Right	• CPE00015
	Left	• CPE00016
600 Series	Right	• CPE00005
	Left	• CPE00006
700 Series	Right	• CPE00007
	Left	• CPE00008
800 Series	Right	• CPE00017
	Left	• CPE00018
900 Series	Right	• CPE00019
	Left	• CPE00020

Tap hole for standard tables and countertops

- Hole that is 33 mm in diameter

Model	Position	Code
Right		• LAVA0001
Left		• LAVA0002
Center		• LAVA0003

Pack of 4 or 6 castors

- Comes with the 40 x 40 mm square legs pre-installed.
- Includes four or six Ø125 mm castors (two with brakes).



Model	For long tables	Code
4 castors	≤ 2000 mm	• F0020312
6 castors	> 2000 mm	• F0020325

• 24-hour shipping

WORK TABLES

Customizations for tables and standard counters

NEW

Waste chute for tables and standard countertops

- Ø 200 mm waste hole with a rubber ring for throwing trash directly into a bin beneath the counter.
- High-density food-service grade rubber.
- Removable rubber ring.



Model	Code
Chute + Rubber Ring	• ADE50001
Rubber ring replacement	• CAD00001

Folded and welded side splash on standard tables and countertops

- Made of AISI grade 304 stainless steel (18/10).
- Folded lateral backsplash with sanitary radius, welded at the corners.
- Additional cost relative to the standard table/countertop price.



Model	Code
Right	• CPDE0001
Left	• CPIE0002
Left and Right*	• CP2E0003

*For countertops of up to 2600 mm

Stainless steel reinforcement omegas on standard tables and countertops

- Substitution of standard omega brackets for stainless steel omega brackets.
- Additional cost relative to the standard table/countertop price.

Dimensions	Countertop only	1 shelf countertop	2 shelf countertop
Up to 1200 mm	• FIX1200E	• FIX1201E	• FIX1202E
Up to 2000 mm	• FIX2000E	• FIX2001E	• FIX2002E
Up to 2800 mm	• FIX2800E	• FIX2801E	• FIX2802E

Option: production in 1.5 mm thick stainless steel AISI 304 of tables and countertops

- Countertops are made out of 1.5 mm thick AISI grade 304 stainless steel (18/10)
- Sturdier.
- Additional cost relative to the standard table/countertop price.

Measurement	Code
Up to 1200 mm	• FESP1512
Up to 2000 mm	• FESP1520
Up to 2800 mm	• FESP1528

• 3-day shipping

WORK TABLES

Cooking and preparation supports

Oven support table

- Made of AISI 304 brushed stainless steel (18/10) with reinforcing omega brackets.
- Supports up to 200 kg of weight.
- Containers not included.
- **No assembly required.**



Gastronorm containers
Page 160

Total dimensions (mm)	Capacity	Number of runners	Code
850 x 750 x 700	GN 1/1	12	• F0050201
850 x 850 x 700	GN 1/1	12	• F0050202
1100 x 850 x 700	GN 1/1 and 2/1	6 + 6	• F0050203
1100 x 950 x 700	GN 1/1 and 2/1	6 + 6	• F0050204
850 x 850 x 700	600 x 400	6	• F0050222



Cutting board table

- Made of AISI grade 304 stainless steel (18/10).
- 40 x 40 mm square stainless steel legs with hidden threaded adjustable feet.
- 30 x 30 mm cross-pieces.
- 50 mm thick polyethylene cutting board included.
- Removable countertop for easy cleaning.
- Fully welded structure for greater durability.
- **No assembly required.**

Total dimensions (mm)	Code
500 x 500 x 880	• F0230001



Polyethylene cutting board

Total dimensions (mm)	White Cutting Board	Red Cutting Board
400 x 300 x 20	• RB040320	• RR040320
500 x 300 x 20	• RB050320	• RR050320
600 x 400 x 20	• RB060420	• RR060420



• 24-hour shipping

WORK TABLES

Coffee Service and Display Cabinet Tables

NEW

Coffee service table

- Exterior made of AISI grade 304 stainless steel (18/10).
- Countertop has stainless steel omega brackets for reinforcement instead of bonded wood.
- Rear backsplash height of 105 mm
- 65 mm front piece with rounded finish
- Drawers made of stainless steel with ball-bearing runners.
- Removable hopper for used coffee, with rubber stopper to dampen the sounds of opening and use.
- Legs with adjustable feet.
- Ø 60 mm hole with cable grommet.
- Stainless steel rear panel is partially open for the installation of the coffee machine.
- **No assembly required.**



Total dimensions (mm)	With countertop	Without countertop
1000 x 600 x 1050	• F3020001	• F3E20001
1500 x 600 x 1050	• F3020002	• F3E20002
2000 x 600 x 1050	• F3020003	• F3E20003
2500 x 600 x 1050	• F3020004	• F3E20004

Display table

- Exterior made of AISI grade 304 stainless steel (18/10).
- Countertop has stainless steel omega brackets for reinforcement instead of bonded wood.
- Rear backsplash height of 105 mm
- 65 mm front piece with rounded finish
- Legs with adjustable feet.
- **No assembly required.**



- **Customizable length available:**
Please indicate the desired length; Price and code of the upper model.



350 Series

Total dimensions (mm)	1 shelf		2 shelves	
	With countertop	Without countertop	With countertop	Without countertop
1000 x 350 x 1050	• F3010002	• F3E10002	• F3010122	• F3E10122
1500 x 350 x 1050	• F3010003	• F3E10003	• F3010123	• F3E10123
2000 x 350 x 1050	• F3010004	• F3E10004	• F3010124	• F3E10124
2500 x 350 x 1050	• F3010008	• F3E10008	• F3010128	• F3E10128

600 Series

Total dimensions (mm)	1 shelf		2 shelves	
	With countertop	Without countertop	With countertop	Without countertop
1000 x 600 x 1050	• F3010005	• F3E10005	• F3010125	• F3E10125
1500 x 600 x 1050	• F3010006	• F3E10006	• F3010126	• F3E10126
2000 x 600 x 1050	• F3010007	• F3E10007	• F3010127	• F3E10127
2500 x 600 x 1050	• F3010009	• F3E10009	• F3010129	• F3E10129

• 24-hour shipping

• 3-day shipping

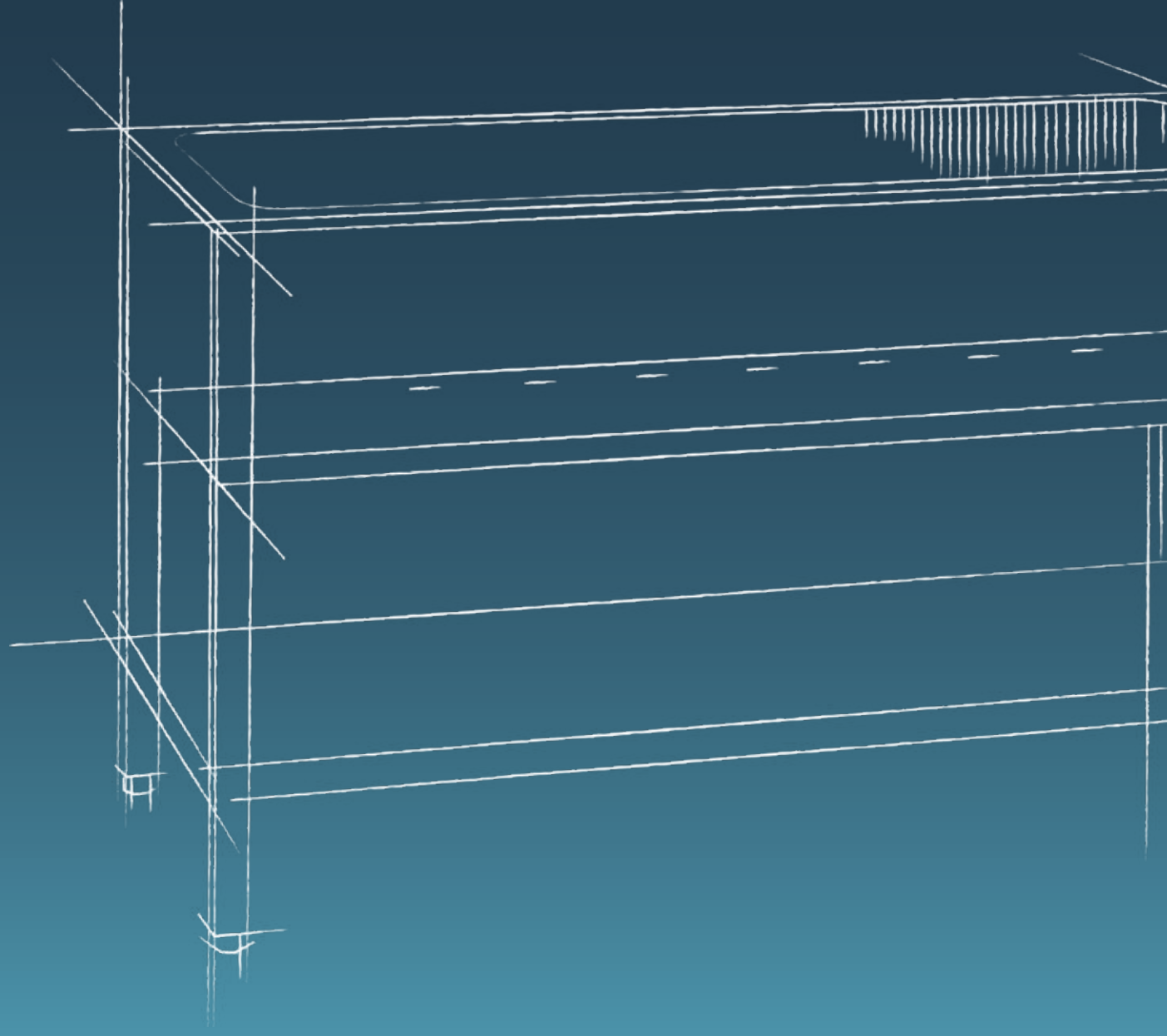

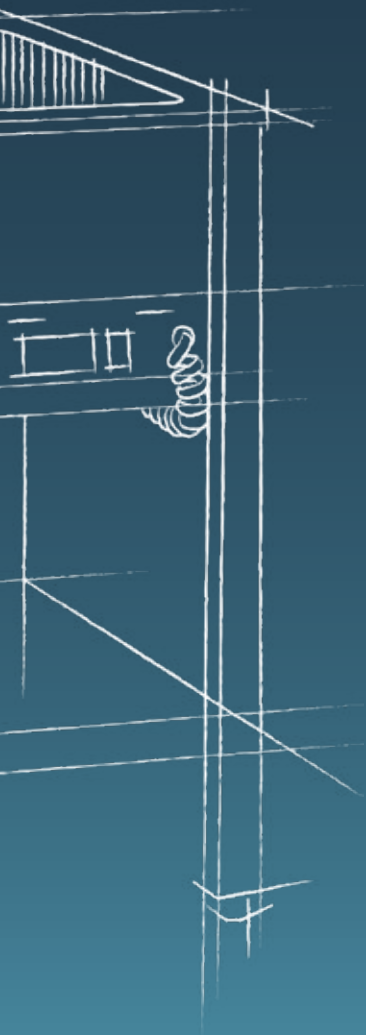

HOT FOOD AND BAIN-MARIE TABLES

Hot food tables	P. 76
Bain-marie tables	P. 78
Countertop bain-marie	P. 79

HOT FOOD AND BAIN-MARIE TABLES

Hot food tables

Hot food tables

- **Designed to keep dishes hot prior to serving.**
- Made of AISI 304 stainless steel (18/10).
- Mineral wool thermal insulation.
- 65 mm front panel with rounded edge. 105 mm high backsplash on wall-facing tables.
- Sliding doors anchored at top. Both sides open in pass-through model.
- Lateral heat blocks with ventilated heating elements that are easily removable.
- Control panel with lighted switch and 0 to 90°C digital thermostat.
- 150 mm legs allow you to raise the height of the unit from 850 to 900 mm.

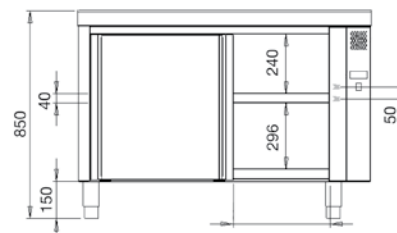

600 Series Center

Total dimensions (mm)	Power (W)	Power supply (V/Hz)	With countertop	Without countertop
1200 x 600 x 850	2000	230/50	• F0440110	• F0080297
1400 x 600 x 850	2000	230/50	• F0440112	• F0080405
1600 x 600 x 850	3000	230/50	• F0440111	• F0080298
1800 x 600 x 850	3000	230/50	• F0440113	• F0080406

700 Series Center

Total dimensions (mm)	Power (W)	Power supply (V/Hz)	With countertop	Without countertop
1200 x 700 x 850	2000	230/50	• F0430110	• F0080197
1400 x 700 x 850	2000	230/50	• F0430113	• F0080407
1600 x 700 x 850	3000	230/50	• F0430111	• F0080198
1800 x 700 x 850	3000	230/50	• F0430112	• F0080199
2000 x 700 x 850	3000	230/50	• F0430114	• F0080408



600 Series Pass-through Center

Total dimensions (mm)	Power (W)	Power supply (V/Hz)	With countertop	Without countertop
1200 x 600 x 850	3000	230/50	• F0440104	• F0080409
1400 x 600 x 850	3000	230/50	• F0440105	• F0080410
1600 x 600 x 850	3000	230/50	• F0440106	• F0080411
1800 x 600 x 850	3000	230/50	• F0440107	• F0080412

700 Series Pass-through Center

Total dimensions (mm)	Power (W)	Power supply (V/Hz)	With countertop	Without countertop
1200 x 700 x 850	3000	230/50	• F0430100	• F0080150
1400 x 700 x 850	3000	230/50	• F0430103	• F0080413
1600 x 700 x 850	3000	230/50	• F0430101	• F0080151
1800 x 700 x 850	3000	230/50	• F0430102	• F0080152
2000 x 700 x 850	3000	230/50	• F0430104	• F0080418

• 3-day shipping



600 series Wall-facing

Total dimensions (mm)	Power (W)	Power supply (V/Hz)	With countertop	Without countertop
1200 x 600 x 850	2000	230/50	• F0440000	• F0080297
1400 x 600 x 850	2000	230/50	• F0440002	• F0080405
1600 x 600 x 850	3000	230/50	• F0440001	• F0080298
1800 x 600 x 850	3000	230/50	• F0440003	• F0080406

700 series Wall-facing

Total dimensions (mm)	Power (W)	Power supply (V/Hz)	With countertop	Without countertop
1200 x 700 x 850	2000	230/50	• F0430000	• F0080197
1400 x 700 x 850	2000	230/50	• F0430003	• F0080407
1600 x 700 x 850	3000	230/50	• F0430001	• F0080198
1800 x 700 x 850	3000	230/50	• F0430002	• F0080199
2000 x 700 x 850	3000	230/50	• F0430004	• F0080408

Hot food tables with GN 1/1 runners

- **Ideal for storing and conserving hot foods in GN 1/1 containers.**
- Made of AISI 304 stainless steel (18/10).
- Mineral wool thermal insulation.
- 65 mm front panel with rounded edge. 105 mm high backsplash on wall-facing tables.
- Control panel with lighted switch and 0 to 90°C digital thermostat.
- Capacity for 21 GN 1/1 containers with three sets of runners.
- 70 mm between runners.
- Swinging doors
- Dry heat reservoir.
- 150 mm legs allow you to raise the height of the unit from 850 to 900 mm.



 **Gastronorm containers**
Page 160

700 Series Center

Total dimensions (mm)	Power (W)	Power supply (V/Hz)	With countertop	Without countertop
1200 x 700 x 850	2000	230/50	• F0432004	• F0080417
1600 x 700 x 850	3000	230/50	• F0432003	• F0082002



700 series Wall-facing

Total dimensions (mm)	Power (W)	Power supply (V/Hz)	With countertop	Without countertop
1200 x 700 x 850	2000	230/50	• F0432005	• F0080417
1600 x 700 x 850	3000	230/50	• F0432002	• F0082002

• 3-day shipping

HOT FOOD AND BAIN-MARIE TABLES

Bain-marie tables

Bain-marie table

- Designed to keep food at optimal serving temperature.
- Made of AISI 304 stainless steel (18/10).
- Basin with safety edges for GN containers with a maximum depth of 200 mm.
- Drain with ball valve.
- Hidden silicone heating elements.
- Lighted switch and adjustable 0-90°C digital thermostat.
- Safety thermostat.
- Stainless steel lower shelf.
- Gastronorm containers not included.
- No assembly required.



Gastronorm containers
Page 160

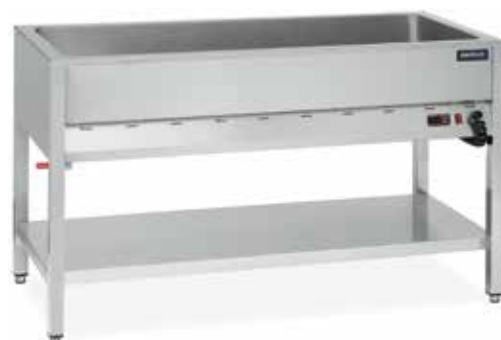
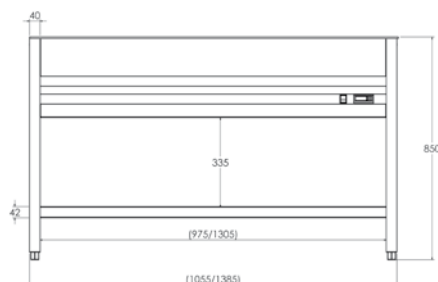

Total dimensions (mm)	Capacity	Power (W)	Power supply (V/Hz)	Code
1055 x 605 x 850	3 GN 1/1	2400	230/50-60	• F0430203
1385 x 605 x 850	4 GN 1/1	3200	230/50-60	• F0430204

Bain-marie table with reserve tank

700 Series

- Made of AISI 304 stainless steel (18/10).
- Countertop with 65 mm fully welded front piece with rounded edges.
- Mineral wool thermal insulation.
- Basin with safety edges on all sides, for GN containers 200 mm deep.
- Hidden resistors with lighted switch and 0 to 90°C digital thermostat.
- Water inlet and drain with ball valve
- Sliding doors anchored at top.
- Dry heat reservoir.
- 150 mm legs allow you to raise the height of the unit from 850 to 900 mm.



Gastronorm containers
Page 160



Total dimensions (mm)	Capacity	Power (W)	Power supply (V/Hz)	Code
1200 x 700 x 850	3 GN 1/1	3200	230/50-60	• F0432011
1600 x 700 x 850	4 GN 1/1	6200	230/50-60	• F0432012

• 3-day shipping

Countertop bain-marie

NEW

Countertop bain-marie for single GN 1/1

- Compact countertop design helps keep food at optimal serving temperature.
- Made of AISI grade 304 stainless steel (18/10).
- Basin inlaid with safety edges for GN 1/1 containers with a maximum depth of 150 mm.
- Adjustable temperature thermostat with LEDs for operation.
- Tap included.
- Gastronorm containers not included.

 **Gastronorm containers**
Page 160



Total dimensions (mm)	Capacity	Power (W)	Power supply (V/Hz)	Code
325 x 560 x 250	1 GN 1/1	1500	230/50-60	• F0420401

Countertop bain-marie for double GN 1/1

- Compact countertop design helps keep food at optimal serving temperature.
- Made of AISI grade 304 stainless steel (18/10).
- Two basins with safety edges for GN 1/1 tubs with a maximum depth of 150 mm.
- Adjustable temperature thermostat with LEDs for operation.
- Independent temperature control for each basin.
- Tap included.
- Gastronorm containers not included.

 **Gastronorm containers**
Page 160



Total dimensions (mm)	Capacity	Power (W)	Power supply (V/Hz)	Code
650 x 560 x 250	2 GN 1/1	3000	230/50-60	• F0420403

BAIN-MARIE TROLLEYS P. 151

• 24-hour shipping

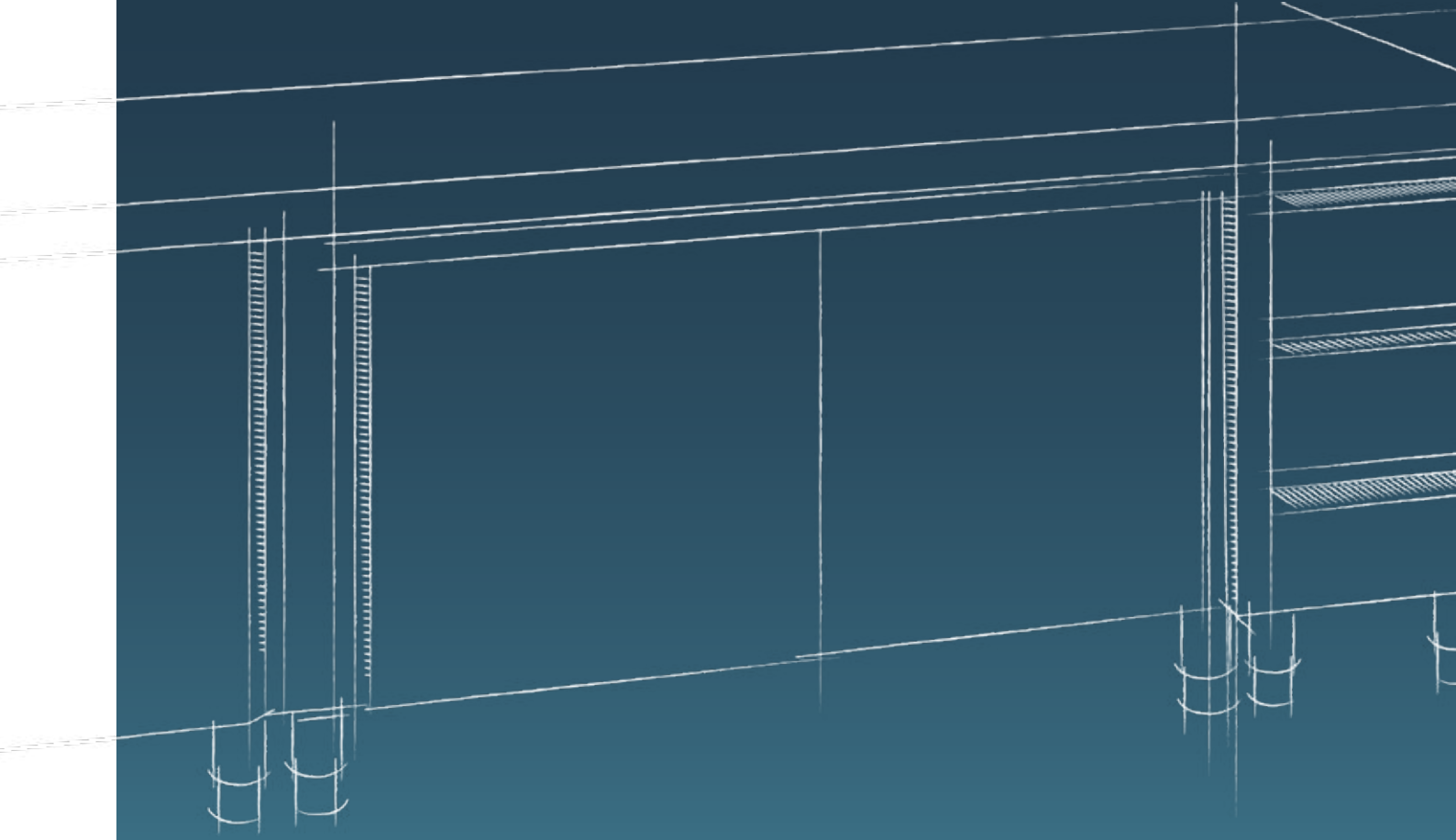



MODULES AND COUNTERTOPS FOR COMPOSITIONS

Units with pass-through shelves	P. 84
Units with shelves	P. 85
Units with pass-through sliding doors	P. 86
Units with sliding doors	P. 87
Units with drawers	P. 88
Units with drawers and swinging doors	P. 89
Modules	P. 90
600-mm-high units	P. 92
Units with drawers and sliding doors	P. 94
Industrial sink units	P. 96
Countertops	P. 98
Customizations	P. 100

**A WIDE RANGE OF
MODULES AND
COUNTERTOPS.
STURDINESS AND HIGH
QUALITY WITH THE
FASTEST POSSIBLE
SERVICE.**

Modular design
adapts to all kinds
of kitchens and
facilities



**THE BEST SOLUTION
TO OPTIMIZE SPACE,
CLEANLINESS, AND
HYGIENE IN THE
KITCHEN**

NEW

Countertops
with basins
that are
customizable in
length



The modular system promotes cleanliness because it creates a continuous countertop, which facilitates sanitary conditions in the kitchen



All units come fully assembled. It is easy and fast to mount the countertop to the modules



Units with wall-facing countertops, center countertops, and without countertops offer the easiest and most efficient way to design your kitchen



MODULES AND COUNTERTOPS FOR COMPOSITIONS

Units with pass-through shelves

NEW

- Made of AISI grade 304 stainless steel (18/10).
- Countertops and shelves have reinforcing omega brackets.
- 65 mm front panel with rounded edge, fully welded.
- 150 mm legs allow you to raise the height of the unit from 850 to 900 mm.
- Adjustable shelf with very sturdy supports.
- **No assembly required.**
- **Countertops on page 98.**



- **Customizable length available:**
Please indicate the desired length;
Price and code of the upper model.



600 Series

	With center countertop	Without countertop
Total dimensions (mm)	Code	Code
600 x 600 x 850	• F0078061	• F0080061
800 x 600 x 850	• F0078062	• F0080062
1000 x 600 x 850	• F0070061	• F0080063
1200 x 600 x 850	• F0070062	• F0080064
1400 x 600 x 850	• F0070063	• F0080065
1600 x 600 x 850	• F0070064	• F0080066
1800 x 600 x 850	• F0070065	• F0080067
2000 x 600 x 850	• F0070066	• F0080068
2200 x 600 x 850	• F0070067	• F0080069
2400 x 600 x 850	• F0070068	• F0080070

700 Series

	With center countertop	Without countertop
Total dimensions (mm)	Code	Code
600 x 700 x 850	• F0078071	• F0080071
800 x 700 x 850	• F0078072	• F0080072
1000 x 700 x 850	• F0070069	• F0080073
1200 x 700 x 850	• F0070070	• F0080074
1400 x 700 x 850	• F0070071	• F0080075
1600 x 700 x 850	• F0070072	• F0080076
1800 x 700 x 850	• F0070073	• F0080077
2000 x 700 x 850	• F0070074	• F0080078
2200 x 700 x 850	• F0070075	• F0080079
2400 x 700 x 850	• F0070076	• F0080080

• 3-day shipping

MODULES AND COUNTERTOPS FOR COOKING

Units with shelves

NEW

- Made of AISI grade 304 stainless steel (18/10).
- Countertops and shelves have reinforcing omega brackets.
- 105 mm backsplash on wall-facing countertops and 65 mm front panel with rounded safety edges, fully welded.
- 150 mm legs allow you to raise the height of the unit from 850 to 900 mm.
- Adjustable shelf with very sturdy supports.
- **No assembly required.**
- **Countertops on page 98.**



- **Customizable length available:**
Please indicate the desired length;
Price and code of the upper model.



600 Series

With wall-facing countertop

With center countertop

Without countertop

Total dimensions (mm)	Code	Code	Code
600 x 600 x 850	• F0078041	• F0079041	• F0080041
800 x 600 x 850	• F0078042	• F0079042	• F0080042
1000 x 600 x 850	• F0070121	• F0070041	• F0080043
1200 x 600 x 850	• F0070122	• F0070042	• F0080044
1400 x 600 x 850	• F0070123	• F0070043	• F0080045
1600 x 600 x 850	• F0070124	• F0070044	• F0080046
1800 x 600 x 850	• F0070125	• F0070045	• F0080047
2000 x 600 x 850	• F0070126	• F0070046	• F0080048
2200 x 600 x 850	• F0070127	• F0070047	• F0080049
2400 x 600 x 850	• F0070128	• F0070048	• F0080050

700 Series

With wall-facing countertop

With center countertop

Without countertop

Total dimensions (mm)	Code	Code	Code
600 x 700 x 850	• F0078051	• F0079051	• F0080051
800 x 700 x 850	• F0078052	• F0079052	• F0080052
1000 x 700 x 850	• F0070129	• F0070049	• F0080053
1200 x 700 x 850	• F0070130	• F0070050	• F0080054
1400 x 700 x 850	• F0070131	• F0070051	• F0080055
1600 x 700 x 850	• F0070132	• F0070052	• F0080056
1800 x 700 x 850	• F0070133	• F0070053	• F0080057
2000 x 700 x 850	• F0070134	• F0070054	• F0080058
2200 x 700 x 850	• F0070135	• F0070055	• F0080059
2400 x 700 x 850	• F0070136	• F0070056	• F0080060

• 3-day shipping

MODULES AND COUNTERTOPS FOR COMPOSITIONS

Units with pass-through sliding doors

NEW

- Made of AISI grade 304 stainless steel (18/10).
- Countertops and shelves have reinforcing omega brackets.
- 65 mm front panel with rounded edge, fully welded.
- 150 mm legs allow you to raise the height of the unit from 850 to 900 mm.
- Adjustable shelf with very sturdy supports.
- Suspended sliding doors glide very smoothly. This design does not use bottom runners, facilitating cleaning.
- **No assembly required.**
- **Countertops on page 98.**



• **Customizable length available:**
Please indicate the desired length;
Price and code of the upper model.



600 Series

	With center countertop	Without countertop
Total dimensions (mm)	Code	Code
1000 x 600 x 850	• F0070021	• F0080021
1200 x 600 x 850	• F0070022	• F0080022
1400 x 600 x 850	• F0070023	• F0080023
1600 x 600 x 850	• F0070024	• F0080024
1800 x 600 x 850	• F0070025	• F0080025
2000 x 600 x 850	• F0070026	• F0080026

700 Series

	With center countertop	Without countertop
Total dimensions (mm)	Code	Code
1000 x 700 x 850	• F0070027	• F0080027
1200 x 700 x 850	• F0070028	• F0080028
1400 x 700 x 850	• F0070029	• F0080029
1600 x 700 x 850	• F0070030	• F0080030
1800 x 700 x 850	• F0070031	• F0080031
2000 x 700 x 850	• F0070032	• F0080032

• **3-day shipping**

MODULES AND COUNTERTOPS FOR COOKING

Units with sliding doors

NEW

- Made of AISI grade 304 stainless steel (18/10).
- Countertops and shelves have reinforcing omega brackets.
- 105 mm backsplash on wall-facing countertops and 65 mm front panel with rounded safety edges, fully welded.
- 150 mm legs allow you to raise the height of the unit from 850 to 900 mm.
- Adjustable shelf with very sturdy supports.
- Suspended sliding doors glide very smoothly. This design does not use bottom runners, facilitating cleaning.
- **No assembly required.**
- **Countertops on page 98.**



- **Customizable length available:**
Please indicate the desired length;
Price and code of the upper model.



600 Series	With wall-facing countertop	With center countertop	Without countertop	For countertops with basin
Total dimensions (mm)	Code	Code	Code	Code
1000 x 600 x 850	• F0070101	• F0070001	• F0080001	• FCU80001
1200 x 600 x 850	• F0070102	• F0070002	• F0080002	• FCU80002
1400 x 600 x 850	• F0070103	• F0070003	• F0080003	• FCU80003
1600 x 600 x 850	• F0070104	• F0070004	• F0080004	• FCU80004
1800 x 600 x 850	• F0070105	• F0070005	• F0080005	• FCU80005
2000 x 600 x 850	• F0070112	• F0070006	• F0080006	• FCU80006

700 Series	With wall-facing countertop	With center countertop	Without countertop	For countertops with basin
Total dimensions (mm)	Code	Code	Code	Code
1000 x 700 x 850	• F0070106	• F0070007	• F0080007	• FCU80007
1200 x 700 x 850	• F0070107	• F0070008	• F0080008	• FCU80008
1400 x 700 x 850	• F0070108	• F0070009	• F0080009	• FCU80009
1600 x 700 x 850	• F0070109	• F0070010	• F0080010	• FCU80010
1800 x 700 x 850	• F0070110	• F0070011	• F0080011	• FCU80011
2000 x 700 x 850	• F0070111	• F0070012	• F0080012	• FCU80012

• **3-day shipping**

MODULES AND COUNTERTOPS FOR COMPOSITIONS

Units with drawers

NEW

- Made of AISI grade 304 stainless steel (18/10).
- Countertops with reinforcing omega brackets.
- 105 mm backsplash on wall-facing countertops and 65 mm front panel with rounded safety edges, fully welded.
- 150 mm legs allow you to raise the height of the unit from 850 to 900 mm.
- Fully removable runners.
- For 400-mm-wide models, drawers measure 289 x 485 x 125 mm of useful space.
- For 500-mm-wide models, drawers measure 389 x 485 x 125 mm of useful space.
- **No assembly required.**
- **Countertops on page 98.**



3 drawers

	With wall-facing countertop	With center countertop	Without countertop
600 Series			
Total dimensions (mm)	Code	Code	Code
400 x 600 x 850	• F0070151	• F0070091	• F0080111
500 x 600 x 850	• F0070152	• F0070092	• F0080112
700 Series			
Total dimensions (mm)	Code	Code	Code
400 x 700 x 850	• F0070155	• F0070095	• F0080113
500 x 700 x 850	• F0070156	• F0070096	• F0080114



4 drawers

	With wall-facing countertop	With center countertop	Without countertop
600 Series			
Total dimensions (mm)	Code	Code	Code
400 x 600 x 850	• F0078121	• F0079121	• F0080121
500 x 600 x 850	• F0078122	• F0079122	• F0080122
700 Series			
Total dimensions (mm)	Code	Code	Code
400 x 700 x 850	• F0078123	• F0079123	• F0080123
500 x 700 x 850	• F0078124	• F0079124	• F0080124

• 3-day shipping

Units with drawers and swinging doors



Drawers and swinging doors

600 Series

Total dimensions (mm)	Doors	Drawers	With wall-facing countertop	With center countertop	Without countertop
			Code	Code	Code
400 x 600 x 850	1	1	• F0078101	• F0079101	• F0080101
500 x 600 x 850	1	1	• F0078102	• F0079102	• F0080102
800 x 600 x 850	2	2	• F0078103	• F0079103	• F0080103
1000 x 600 x 850	2	2	• F0078104	• F0079104	• F0080104

700 Series

Total dimensions (mm)	Doors	Drawers	Code	Code	Code
			Code	Code	Code
400 x 700 x 850	1	1	• F0078106	• F0079106	• F0080106
500 x 700 x 850	1	1	• F0078107	• F0079107	• F0080107
800 x 700 x 850	2	2	• F0078108	• F0079108	• F0080108
1000 x 700 x 850	2	2	• F0078109	• F0079109	• F0080109



Swinging doors

600 Series

Total dimensions (mm)	Doors	With wall-facing countertop	With center countertop	Without countertop	For countertops with basin
		Code	Code	Code	Code
400 x 600 x 850	1	• F0070141	• F0070081	• F0080091	-
500 x 600 x 850	1	• F0070142	• F0070082	• F0080092	-
600 x 600 x 850	1	• F0078093	• F0079093	• F0080093	• FCU80093
800 x 600 x 850	2	• F0070143	• F0070083	• F0080094	• FCU80094
1000 x 600 x 850	2	• F0070144	• F0070084	• F0080095	• FCU80095

700 Series

Total dimensions (mm)	Doors	Code	Code	Code	Code
		Code	Code	Code	Code
400 x 700 x 850	1	• F0070145	• F0070085	• F0080096	-
500 x 700 x 850	1	• F0070146	• F0070086	• F0080097	-
600 x 700 x 850	1	• F0078098	• F0079098	• F0080098	• FCU80098
800 x 700 x 850	2	• F0070147	• F0070087	• F0080099	• FCU80099
1000 x 700 x 850	2	• F0070148	• F0070088	• F0080100	• FCU80100

• 3-day shipping

MODULES AND COUNTERTOPS FOR COMPOSITIONS

Modules

High capacity drawer



600 Series

Total dimensions (mm)
500 x 600 x 850

With wall-facing countertop

Code
• F0078132

With center countertop

Code
• F0079132

Without countertop

Code
• F0080132

700 Series

Total dimensions (mm)
500 x 700 x 850

Code
• F0078139

Code
• F0079139

Code
• F0080139

Baseless unit for waste container



600 Series

Total dimensions (mm)
600 x 600 x 850

With wall-facing countertop

Code
• F0078501

With center countertop

Code
• F0079501

Without countertop

Code
• F0080501

700 Series

Total dimensions (mm)
600 x 700 x 850

Code
• F0078502

Code
• F0079502

Code
• F0080502

90° corner countertop

- Made of AISI grade 304 stainless steel (18/10).
- To connect with a countertop with the lateral coupling module.
- Straight corners to connect to another countertop.
- 105 mm backsplash and 65 mm front panel with rounded safety edges, fully welded.
- 150 mm legs allow you to raise the height of the unit from 850 to 900 mm.

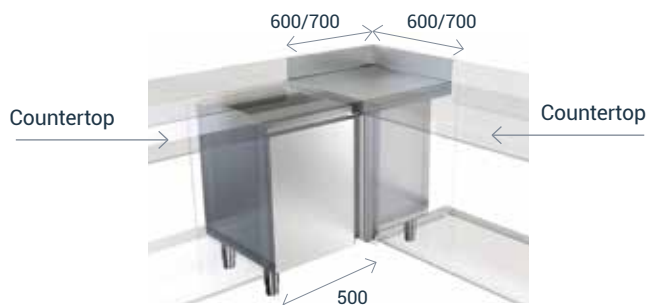

600 Series

Total dimensions (mm)	Corner countertop	Code
1100 x 600 x 850	Right	• F0080701
1100 x 600 x 850	Left	• F0080702

700 Series

Total dimensions (mm)	Corner countertop	Code
1200 x 700 x 850	Right	• F0080703
1200 x 700 x 850	Left	• F0080704

Frame with door

600/700 Series

Total dimensions (width x height) (mm)	Code
500 x 670	• F0080901
600 x 670	• F0080902

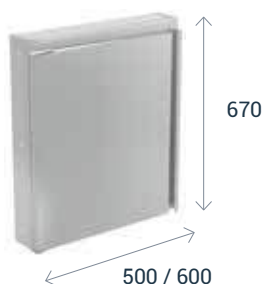

• 3-day shipping

90° chamfered corner unit

600 Series

Total dimensions (mm)	Code
1000 x 1000 x 600 x 850	• F0070116

700 Series

Total dimensions (mm)	Code
1000 x 1000 x 700 x 850	• F0070117



Runner set unit



600 Series

Total dimensions (mm)	Capacity	With wall-facing countertop	With center countertop	Without countertop
		Code	Code	Code
400 x 600 x 850	1 GN 1/1 body	• F0780141	• F0790141	• F0080141
800 x 600 x 850	2 GN 1/1 bodies	• F0780143	• F0790143	• F0080143

700 Series

Total dimensions (mm)	Capacity	Code	Code	Code
400 x 700 x 850	1 GN 1/1 body	• F0780145	• F0790145	• F0080145
500 x 700 x 850	One 600 x 400 body	• F0780146	• F0790146	• F0080146
800 x 700 x 850	2 GN 1/1 bodies	• F0780147	• F0790147	• F0080147
1000 x 700 x 850	2 600 x 400 bodies	• F0780148	• F0790148	• F0080148

Hot food tables without countertop



600 Series

Total dimensions (mm)	wall-facing module	Center pass-through module	Unit with GN 1/1 guides
		Code	Code
1200 x 600 x 850 *	• F0080297	• F0080409	-
1400 x 600 x 850 *	• F0080405	• F0080410	-
1600 x 600 x 850 **	• F0080298	• F0080411	-
1800 x 600 x 850 **	• F0080406	• F0080412	-

* Power 2000W - Voltage 230 V / ** Power: 3000W - Voltage 230 V

700 Series

Total dimensions (mm)	Code	Code	Code
1200 x 700 x 850 *	• F0080197	• F0080150	• F0080417
1400 x 700 x 850 *	• F0080407	• F0080413	-
1600 x 700 x 850 **	• F0080198	• F0080151	• F0082002
1800 x 700 x 850 **	• F0080199	• F0080152	-
2000 x 700 x 850 **	• F0080408	• F0080418	-

* Power 2000W - Voltage 230 V / ** Power: 3000W - Voltage 230 V

HOT FOOD TABLES WITH COUNTERTOPS P. 76/77

• 3-day shipping

MODULES AND COUNTERTOPS FOR COMPOSITIONS

600-mm-high units

NEW

600-mm-high unit with an open face

- Made of AISI grade 304 stainless steel (18/10).
- Countertops and shelves have reinforcing omega brackets.
- 105 mm backsplash on wall-facing countertops and 65 mm front panel with rounded safety edges, fully welded.
- 150 mm legs allow you to raise the height of the unit from 600 to 650 mm.
- **No assembly required.**
- **Countertops on page 98.**



• **Customizable length available:**
Please indicate the desired length;
Price and code of the upper model.



600 Series

	With wall-facing countertop	With center countertop	Without countertop
Total dimensions (mm)	Code	Code	Code
600 x 600 x 600	• F0781001	• F0791001	• F0081001
800 x 600 x 600	• F0781002	• F0791002	• F0081002
1000 x 600 x 600	• F0781003	• F0791003	• F0081003
1200 x 600 x 600	• F0781004	• F0791004	• F0081004
1400 x 600 x 600	• F0781005	• F0791005	• F0081005
1600 x 600 x 600	• F0781006	• F0791006	• F0081006



700 Series

	With wall-facing countertop	With center countertop	Without countertop
Total dimensions (mm)	Code	Code	Code
600 x 700 x 600	• F0781007	• F0791007	• F0081007
800 x 700 x 600	• F0781008	• F0791008	• F0081008
1000 x 700 x 600	• F0781009	• F0791009	• F0081009
1200 x 700 x 600	• F0781010	• F0791010	• F0081010
1400 x 700 x 600	• F0781011	• F0791011	• F0081011
1600 x 700 x 600	• F0781012	• F0791012	• F0081012

• **3-day shipping**

NEW

600-mm-high unit with swinging doors

- Made of AISI grade 304 stainless steel (18/10).
- Countertops and shelves have reinforcing omega brackets.
- 105 mm backsplash on wall-facing countertops and 65 mm front panel with rounded safety edges, fully welded.
- 150 mm legs allow you to raise the height of the unit from 600 to 650 mm.
- **No assembly required.**
- **Countertops on page 98.**



600 Series

With wall-facing countertop

With center countertop

Without countertop

Total dimensions (mm)	Code	Code	Code
400 x 600 x 600	• F0781020	• F0791020	• F0081020
500 x 600 x 600	• F0781021	• F0791021	• F0081021
600 x 600 x 600	• F0781022	• F0791022	• F0081022
800 x 600 x 600	• F0781023	• F0791023	• F0081023
1000 x 600 x 600	• F0781024	• F0791024	• F0081024



700 Series

With wall-facing countertop

With center countertop

Without countertop

Total dimensions (mm)	Code	Code	Code
400 x 700 x 600	• F0781025	• F0791025	• F0081025
500 x 700 x 600	• F0781026	• F0791026	• F0081026
600 x 700 x 600	• F0781027	• F0791027	• F0081027
800 x 700 x 600	• F0781028	• F0791028	• F0081028
1000 x 700 x 600	• F0781029	• F0791029	• F0081029

• 3-day shipping

MODULES AND COUNTERTOPS FOR COMPOSITIONS

Unit with cabinets and sliding doors

NEW

Unit with left-side drawers and sliding doors

- Made of AISI 304 stainless steel (18/10).
- Countertops and shelves have reinforcing omega brackets.
- 105 mm backsplash on wall-facing countertops and 65 mm front panel with rounded safety edges, fully welded.
- Adjustable shelf with very sturdy supports.
- 150 mm legs allow you to raise the height of the unit from 850 to 900 mm.
- Suspended sliding doors glide very smoothly. This design does not use bottom runners, facilitating cleaning.
- Useable volume of drawers is 289 x 485 x 125 mm
- **No assembly required.**
- **Countertops on page 98.**

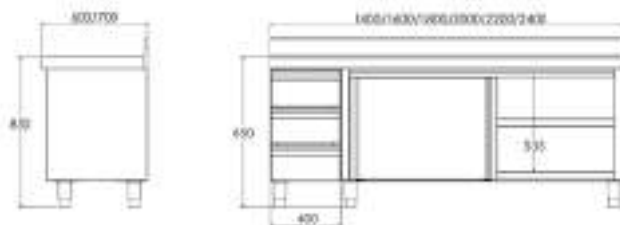

• **Customizable length available:**
Please indicate the desired length;
Price and code of the upper model.



600 Series

Total dimensions (mm)

1400 x 600 x 850
1600 x 600 x 850
1800 x 600 x 850
2000 x 600 x 850
2200 x 600 x 850
2400 x 600 x 850

With wall-facing countertop

Code

- F0071111
- F0071112
- F0071113
- F0071114
- F0071115
- F0071116

With center countertop

Code

- F0071011
- F0071012
- F0071013
- F0071014
- F0071015
- F0071016

Without countertop

Code

- F0083011
- F0083012
- F0083013
- F0083014
- F0083015
- F0083016

700 Series

Total dimensions (mm)

1400 x 700 x 850
1600 x 700 x 850
1800 x 700 x 850
2000 x 700 x 850
2200 x 700 x 850
2400 x 700 x 850

With wall-facing countertop

Code

- F0071131
- F0071132
- F0071133
- F0071134
- F0071135
- F0071136

With center countertop

Code

- F0071031
- F0071032
- F0071033
- F0071034
- F0071035
- F0071036

Without countertop

Code

- F0083031
- F0083032
- F0083033
- F0083034
- F0083035
- F0083036

• **3-day shipping**

NEW

Unit with right-side drawers and sliding doors

- Made of AISI 304 stainless steel (18/10).
- Countertops and shelves have reinforcing omega brackets.
- 105 mm backsplash on wall-facing countertops and 65 mm front panel with rounded safety edges, fully welded.
- Adjustable shelf with very sturdy supports.
- 150 mm legs allow you to raise the height of the unit from 850 to 900 mm.
- Suspended sliding doors glide very smoothly. This design does not use bottom runners, facilitating cleaning.
- Useable volume of drawers is 289 x 485 x 125 mm
- **No assembly required.**
- **Countertops on page 98.**

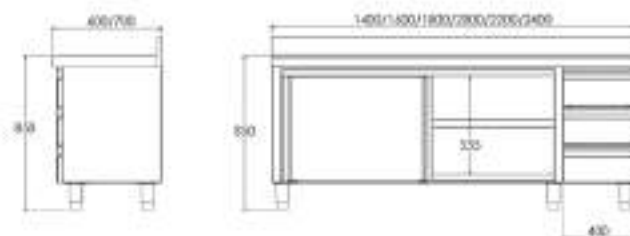

- **Customizable length available:**
Please indicate the desired length;
Price and code of the upper model.



600 Series

	With wall-facing countertop	With center countertop	Without countertop
Total dimensions (mm)	Code	Code	Code
1400 x 600 x 850	• F0071101	• F0071001	• F0083101
1600 x 600 x 850	• F0071102	• F0071002	• F0083102
1800 x 600 x 850	• F0071103	• F0071003	• F0083103
2000 x 600 x 850	• F0071104	• F0071004	• F0083104
2200 x 600 x 850	• F0071105	• F0071005	• F0083105
2400 x 600 x 850	• F0071106	• F0071006	• F0083106

700 Series

	With wall-facing countertop	With center countertop	Without countertop
Total dimensions (mm)	Code	Code	Code
1400 x 700 x 850	• F0071121	• F0071021	• F0083021
1600 x 700 x 850	• F0071122	• F0071022	• F0083022
1800 x 700 x 850	• F0071123	• F0071023	• F0083023
2000 x 700 x 850	• F0071124	• F0071024	• F0083024
2200 x 700 x 850	• F0071125	• F0071025	• F0083025
2400 x 700 x 850	• F0071126	• F0071026	• F0083026

• **3-day shipping**

MODULES AND COUNTERTOPS FOR COMPOSITIONS

Industrial sink units

NEW

600 Series



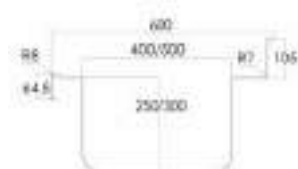













- Made of AISI grade 304 stainless steel (18/10).
- 105 mm backsplash and 65 mm front panel with rounded safety edges, fully welded.
- Basins inlaid with sound-proofing protection.
- Inlaid drain valve and overflow pipe included in each basin.
- 150 mm legs allow you to raise the height of the unit from 850 to 900 mm.
- Rear legs raised 50 mm to allow you to set the industrial sink unit on a floor with a sanitary radius.
- Open rear section to facilitate access to installations.
- Available with hinged or sliding doors depending on the model.
- Taps not included.
- **No assembly required.**



 **Taps** page 33



600 Series

Total dimensions (mm)	Basin dimensions (mm)	Unit with doors	Unit with doors and space for dishwasher
600 x 600	 500 x 400 x 250	• FP960600 Swinging	-
	 400 x 400 x 250	• FP91060D Sliding	-
1000 x 600	 400 x 400 x 250	• FP91060I Sliding	-
	 400 x 400 x 250	• FP910600 Sliding	-
	 500 x 400 x 250	• FP91260D Sliding	• FP9126LD Swinging
1200 x 600	 500 x 400 x 250	• FP91260I Sliding	• FP9126LI Swinging
	 500 x 400 x 250	• FP912600 Sliding	-
	 400 x 400 x 250	• FP91460D Sliding	-
1400 x 600	 400 x 400 x 250	• FP91460I Sliding	-
	 500 x 400 x 250	• FP91461D Sliding	• FP9146LD Swinging
	 500 x 400 x 250	• FP91461I Sliding	• FP9146LI Swinging
1600 x 600	 500 x 400 x 250	• FP91660D Sliding	-
	 500 x 400 x 250	• FP91660I Sliding	-
1800 x 600	 500 x 400 x 300	• FP91860D Sliding	• FP9186LD Sliding
	 500 x 400 x 300	• FP91860I Sliding	• FP9186LI Sliding
2000 x 600	 500 x 400 x 250	• FP920600 Sliding	-

• 3-day shipping

NEW

700 Series



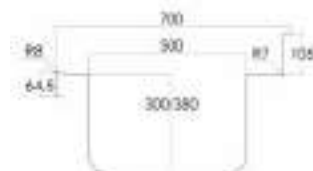







- Made of AISI grade 304 stainless steel (18/10).
- 105 mm backsplash and 65 mm front panel with rounded safety edges, fully welded.
- Basins inlaid with sound-proofing protection.
- Inlaid drain valve and overflow pipe included in each basin.
- 150 mm legs allow you to raise the height of the unit from 850 to 900 mm.
- Rear legs raised 50 mm to allow you to set the Industrial sink unit on a floor with a sanitary radius.
- Open rear section to facilitate access to installations.
- Available with hinged or sliding doors depending on the model.
- Taps not included.
- **No assembly required.**



 **Taps** page 33



700 Series

Total dimensions (mm)	Basin dimensions (mm)	Unit with doors	Unit with doors and space for dishwasher
700 x 700	 500 x 500 x 300	• FP970700 Swinging	-
1000 x 700	 500 x 500 x 300	• FP91070D Sliding	-
	 500 x 500 x 300	• FP91070I Sliding	-
1200 x 700	 500 x 400 x 250	• FP910700 Sliding	-
	 500 x 500 x 300	• FP91270D Sliding	• FP9127LD Swinging
	 500 x 500 x 300	• FP91270I Sliding	• FP9127LI Swinging
1400 x 700	 500 x 500 x 300	• FP912700 Sliding	-
	 600 x 500 x 300	• FP91470D Sliding	• FP9147LD Swinging
	 600 x 500 x 300	• FP91470I Sliding	• FP9147LI Swinging
1600 x 700	 600 x 500 x 300	• FP914700 Sliding	-
	 500 x 500 x 300	• FP91670D Sliding	-
	 500 x 500 x 300	• FP91670I Sliding	-
1800 x 700	 500 x 500 x 300	• FP91870D Sliding	• FP9187LD Sliding
	 500 x 500 x 300	• FP91870I Sliding	• FP9187LI Sliding
	 500 x 500 x 300	• FP918700 Sliding	-
2000 x 700	 1160 x 500 x 380	• FP92070D Sliding	-
	 1160 x 500 x 380	• FP92070I Sliding	-

• **3-day shipping**

MODULES AND COUNTERTOPS FOR COMPOSITIONS

Center and wall-facing countertop

NEW

Countertop

- Built with AISI grade 304 brushed stainless steel (18/10).
- With reinforcing omega brackets.
- 105 mm backsplash and 65 mm front panel with rounded safety edges, fully welded.



- **Customizable length available:**
Please indicate the desired length;
Price and code of the upper model.



600 Series

Total dimensions (mm)	Center Countertop	Wall-facing countertop
400 x 600	• F0080301	• F0080351
500 x 600	• F0080302	• F0080352
600 x 600	• F0080303	• F0080353
700 x 600	• F0080419	• F0080420
800 x 600	• F0080304	• F0080354
900 x 600	• F0080401	• F0080403
1000 x 600	• F0080305	• F0080355
1100 x 600	• F0080306	• F0080356
1200 x 600	• F0080307	• F0080357
1300 x 600	• F0080308	• F0080358
1400 x 600	• F0080309	• F0080359
1500 x 600	• F0080310	• F0080360
1600 x 600	• F0080311	• F0080361
1700 x 600	• F0080312	• F0080362
1800 x 600	• F0080313	• F0080363
1900 x 600	• F0080314	• F0080364
2000 x 600	• F0080315	• F0080365
2100 x 600	• F0080316	• F0080366
2200 x 600	• F0080317	• F0080367
2300 x 600	• F0080318	• F0080368
2400 x 600	• F0080319	• F0080369
2500 x 600	• F0080320	• F0080370
2600 x 600	• F0080321	• F0080371
2700 x 600	• F0080322	• F0080372
2800 x 600	• F0080323	• F0080373



700 Series

Total dimensions (mm)	Center Countertop	Wall-facing countertop
400 x 700	• F0080326	• F0080376
500 x 700	• F0080327	• F0080377
600 x 700	• F0080328	• F0080378
700 x 700	• F0080421	• F0080422
800 x 700	• F0080329	• F0080379
900 x 700	• F0080402	• F0080404
1000 x 700	• F0080330	• F0080380
1100 x 700	• F0080331	• F0080381
1200 x 700	• F0080332	• F0080382
1300 x 700	• F0080333	• F0080383
1400 x 700	• F0080334	• F0080384
1500 x 700	• F0080335	• F0080385
1600 x 700	• F0080336	• F0080386
1700 x 700	• F0080337	• F0080387
1800 x 700	• F0080338	• F0080388
1900 x 700	• F0080339	• F0080389
2000 x 700	• F0080340	• F0080390
2100 x 700	• F0080341	• F0080391
2200 x 700	• F0080342	• F0080392
2300 x 700	• F0080343	• F0080393
2400 x 700	• F0080344	• F0080394
2500 x 700	• F0080345	• F0080395
2600 x 700	• F0080346	• F0080396
2700 x 700	• F0080347	• F0080397
2800 x 700	• F0080348	• F0080398

• 3-day shipping

MODULES AND COUNTERTOPS FOR COOKING

Wall-facing countertop with basin

NEW

Countertop with basin

- Built with AISI grade 304 brushed stainless steel (18/10).
- With reinforcing omega brackets.
- 105 mm backsplash and 65 mm front panel with rounded safety edges, fully welded.
- 500 x 400 x 250 mm welded basin.



- **Customizable length available:**
Please indicate the desired length;
Price and code of the upper model.

 Taps page 33



600 Series

Total dimensions (mm)	Countertop with right basin	Countertop with left basin	Countertop with center basin
1000 x 600	• FEC1006D	• FEC1006I	• FEC1006C
1200 x 600	• FEC1206D	• FEC1206I	• FEC1206C
1400 x 600	• FEC1406D	• FEC1406I	• FEC1406C
1500 x 600	• FEC1506D	• FEC1506I	• FEC1506C
1600 x 600	• FEC1606D	• FEC1606I	• FEC1606C
1800 x 600	• FEC1806D	• FEC1806I	• FEC1806C
2000 x 600	• FEC2006D	• FEC2006I	• FEC2006C
2200 x 600	• FEC2206D	• FEC2206I	• FEC2206C
2400 x 600	• FEC2406D	• FEC2406I	• FEC2406C
2600 x 600	• FEC2606D	• FEC2606I	• FEC2606C
2800 x 600	• FEC2806D	• FEC2806I	• FEC2806C

700 Series

Total dimensions (mm)	Countertop with right basin	Countertop with left basin	Countertop with center basin
1000 x 700	• FEC1007D	• FEC1007I	• FEC1007C
1200 x 700	• FEC1207D	• FEC1207I	• FEC1207C
1400 x 700	• FEC1407D	• FEC1407I	• FEC1407C
1500 x 700	• FEC1507D	• FEC1507I	• FEC1507C
1600 x 700	• FEC1607D	• FEC1607I	• FEC1607C
1800 x 700	• FEC1807D	• FEC1807I	• FEC1807C
2000 x 700	• FEC2007D	• FEC2007I	• FEC2007C
2200 x 700	• FEC2207D	• FEC2207I	• FEC2207C
2400 x 700	• FEC2407D	• FEC2407I	• FEC2407C
2600 x 700	• FEC2607D	• FEC2607I	• FEC2607C
2800 x 700	• FEC2807D	• FEC2807I	• FEC2807C

• 3-day shipping

MODULES AND COUNTERTOPS FOR COMPOSITIONS

Customizations for countertops

NEW

Countertop waste chute

- Ø 200 mm waste chute with a rubber ring for throwing trash directly into a bin beneath the counter.
- High-density food-service grade rubber.
- Removable rubber ring.



Model	Code
Chute + Rubber Ring	• ADE50001
Rubber ring replacement	• CAD00001

Folded and welded side splash on countertops

- Made of AISI grade 304 stainless steel (18/10).
- Folded lateral backsplash with sanitary radius, welded at the corners.
- Additional cost relative to the standard countertop price:



Model	Code
Right	• CPDE0001
Left	• CPIE0002
Right + Left *	• CP2E0003

*For countertops of up to 2600 mm

Tap hole in countertop

- * 33 mm diameter hole

Model	Position	Code
Right		• LAVA0001
Left		• LAVA0002
Center		• LAVA0003
Between basins		• LAVA0004

1.5 mm thick countertop

- Countertops are made out of 1.5 mm thick AISI grade 304 stainless steel (18/10)
- Sturdier.
- Additional cost relative to the standard countertop price:

Measurement	Code
Up to 1200 mm	• FESP1512
Up to 2000 mm	• FESP1520
Up to 2800 mm	• FESP1528

Pack of 4 or 6 castors

- These are attached to the legs of the modular furnishings before shipping.
- Includes four or six Ø150 mm castors (two with brakes).

Model	For long modules	Code
4 castors	≤ 2000 mm	• FRU80001
6 castors	> 2000 mm	• FRU80002

Baseboards

- Made of AISI grade 304 stainless steel (18/10).
- Easy installation.

Measurement	Code
400	• FZ000400
600	• FZ000600
800	• FZ000800
1000	• FZ001000
1200	• FZ001200
1400	• FZ001400
1600	• FZ001600
1800	• FZ001800
2000	• FZ002000
Side 600	• FZL00600
Side 700	• FZL00700

Stainless steel reinforcing omega brackets on countertops

- Substitution of standard omega brackets for stainless steel omega brackets.
- Additional cost relative to the standard countertop price:

Dimensions	Countertop only	1 shelf countertop	2 shelf countertop
Up to 1200 mm	• FIX1200E	• FIX1201E	• FIX1202E
Up to 2000 mm	• FIX2000E	• FIX2001E	• FIX2002E
Up to 2800 mm	• FIX2800E	• FIX2801E	• FIX2802E

• 3-day shipping

MODULES AND COUNTERTOPS FOR COMPOSITIONS

Example of possible arrangement



Description	Total dimensions (mm)	Code
1. 700 Series Center countertop	2400 x 700	F0080344
2. 700 Series baseless module for waste container	600 x 700 x 850	F0080502
3. 700 Series baseless module for waste container	1400 x 700 x 850	F0080009
4. 700 Series three drawer module without countertop	400 x 700 x 850	F0080113

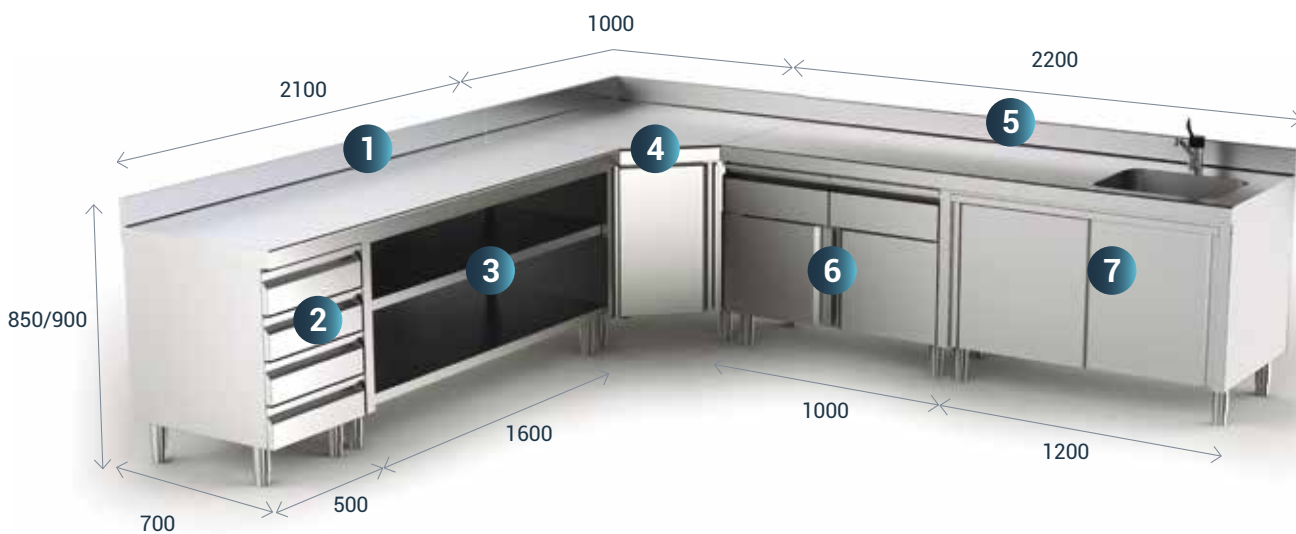

Description	Total dimensions (mm)	Code
1. 700 Series wall-facing countertop	2100 x 700	F0080391
2. 700 Series four drawer module without countertop	500 x 700 x 850	F0080124
3. 700 Series module with shelves, no countertop	1600 x 700 x 850	F0080056
4. 700 Series 90° chamfered corner unit	1000 x 1000 x 700 x 850	F0070117
5. 700 Series wall-facing countertop with right-side basin	2200 x 700	FEC2007D
6. 700 Series module with drawers and swinging doors, no countertop	1000 x 700 x 850	F0080109
7. 700 Series sliding door module for countertop with basin	1200 x 700 x 850	FCU80008

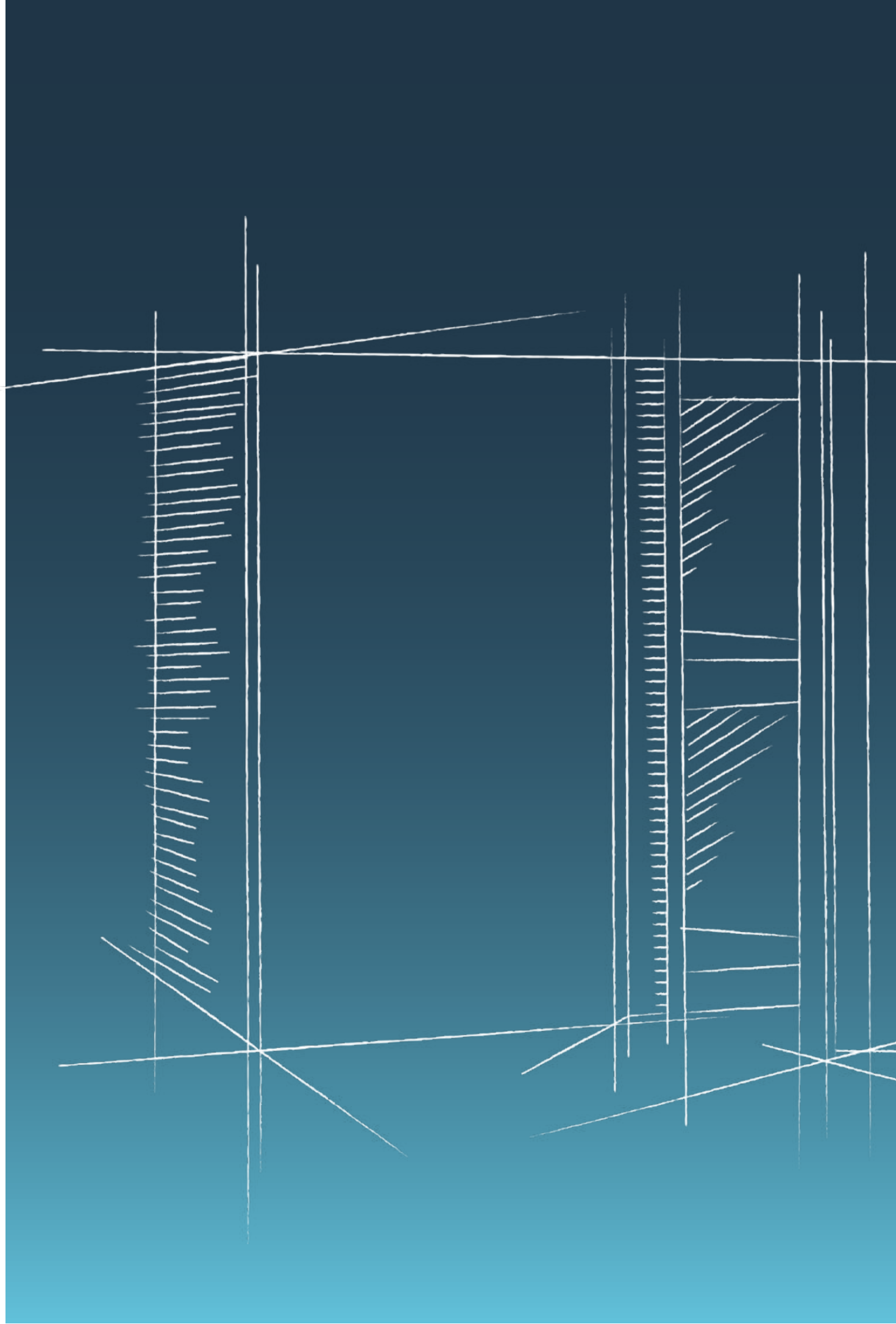

CABINETS

Wall-mounted cabinets **P. 104**

Plate warming cabinets **P. 105**

Supports **P. 105**

Freestanding cabinets **P. 106**

CABINETS Wall-mounted

Wall cabinet

- For daily use in organizing a commercial kitchen.
- Made of AISI grade 304 brushed stainless steel (18/10).
- Middle shelf with adjustable height.
- Easy wall mounting.
- Models with swinging doors open on the right side.
- Corner model is designed to connect cabinets in 90° corners.
- Adjustable wall system for inclines greater than 1cm.
- No assembly required.



Unit with dish rack

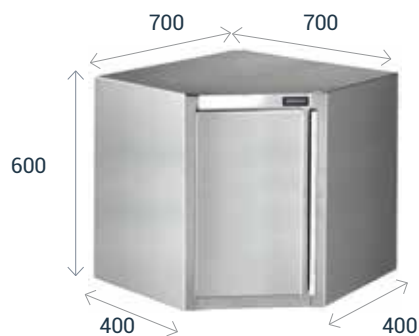

Swinging doors

Total dimensions (mm)	Doors	Code
400 x 400 x 600	1	• F0240134
500 x 400 x 600	1	• F0240135
800 x 400 x 600	2	• F0240136
1000 x 400 x 600	2	• F0240137

Sliding doors

Total dimensions (mm)	With Shelf	With Dish rack
1000 x 400 x 600	• F0240101	• F0240111
1200 x 400 x 600	• F0240102	• F0240112
1400 x 400 x 600	• F0240104	-
1600 x 400 x 600	• F0240103	-
1800 x 400 x 600	• F0240105	-

Open

Total dimensions (mm)	Code
1000 x 400 x 600	• F0240130
1200 x 400 x 600	• F0240131
1400 x 400 x 600	• F0240132
1600 x 400 x 600	• F0240133

90° corner

Total dimensions (mm)	Code
700 x 400 x 600	• F0240121

• 24-hour shipping

CABINETS

Plate warming cabinets and supports

NEW

Plate warming cabinet

- Keeps plates hot during service.
- Made of AISI grade 304 stainless steel (18/10).
- Lighted switch and adjustable 0-90°C analog thermostat.
- Single unit: 1 adjustable middle shelf.
- Double unit: 2 adjustable middle shelves.
- Modular model: Easy to install on the bottom shelf of a work table.



Single

Total dimensions (mm)	Power (W)	Power supply (V/Hz)	Plate capacity*	Code
400 x 460 x 870	400	230/50-60	60	• F0420301

* Ø 310 mm



Double

Total dimensions (mm)	Power (W)	Power supply (V/Hz)	Plate capacity*	Code
800 x 460 x 870	1500	230/50	120	• F0420302

* Ø 310 mm



Modular

Total dimensions (mm)	Power (W)	Power supply (V/Hz)	Plate capacity	Code
400 x 460 x 570	400	230/50-60	30	• F0420306

* Ø 290 mm

Utensil hanging rack

- Made of Ø8 mm AISI 304 18/10 stainless steel tube.
- Welded plates with holes for wall installation (screws and plugs included).



Total dimensions (mm)	Ø	Code
600 x 48	8 mm	• F0210201

• 24-hour shipping

CABINETS

Freestanding

Freestanding cabinet

- **Facilitates storage and organization in the kitchen.**
- Made of AISI grade 304 brushed stainless steel (18/10).
- All models include 3 stainless steel shelves with reinforcing omega brackets. The center shelf is fixed and the other two are adjustable.
- Maximum load per shelf: 80 kg.
- Lock with key included.
- 150 mm legs allow you to raise the height of the unit from 850 to 900 mm.
- No assembly required.

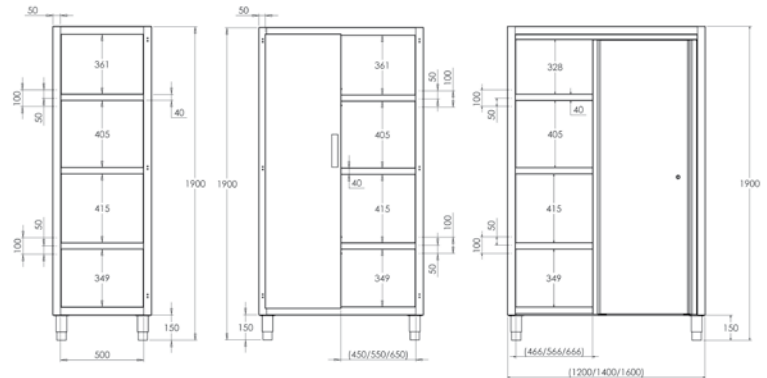

Swinging doors

Total dimensions (mm)	Code	Doors
600 x 600 x 1900	• F0240000	1
1000 x 600 x 1900	• F0240006	2
1200 x 600 x 1900	• F0240007	2
1400 x 600 x 1900	• F0240008	2
1600 x 600 x 1900	-	-

Sliding doors

Code	Doors
-	-
• F0240001	2
• F0240002	2
• F0240003	2

Sloped protector for freestanding cabinet

- **Useful for preventing the build-up of dust and dirt on top of the cabinet.**
- Made of AISI grade 304 brushed stainless steel (18/10).
- Easily installed on freestanding cabinets.

Total dimensions (mm)	Swinging doors	Sliding doors
600 x 600 x 200	• F0240402	-
1000 x 600 x 200	• F0240403	-
1200 x 600 x 200	• F0240404	• F0240406
1400 x 600 x 200	• F0240405	• F0240407
1600 x 600 x 200	-	• F0240408



• 24-hour shipping

Cabinet for cleaning products

- **Designed to organize and separate cleaning products, keeping them out-of-sight in the work area.**
- Made of AISI grade 304 brushed stainless steel (18/10).
- Comes with 3 stainless steel middle shelves and space to organize and separate cleaning products and items.
- Lock with key included.
- 150 mm legs allow you to raise the height of the unit from 850 to 900 mm.
- No assembly required.

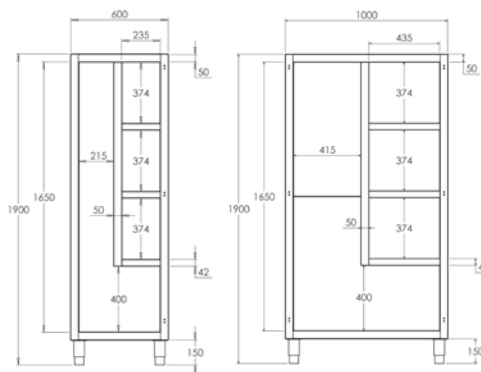

Total dimensions (mm)	Swinging doors	Code
600 x 450 x 1900	1	• F0240201
1000 x 450 x 1900	2	• F0240202

Sloped protector for cleaning cabinet

- **Useful for preventing the build-up of dust and dirt on top of the cabinet.**
- Made of AISI grade 304 brushed stainless steel (18/10).
- Easily installed on freestanding cabinets.

Total dimensions (mm)	Code
600 x 450 x 200	• F0240410
1000 x 450 x 200	• F0240409



• 24-hour shipping

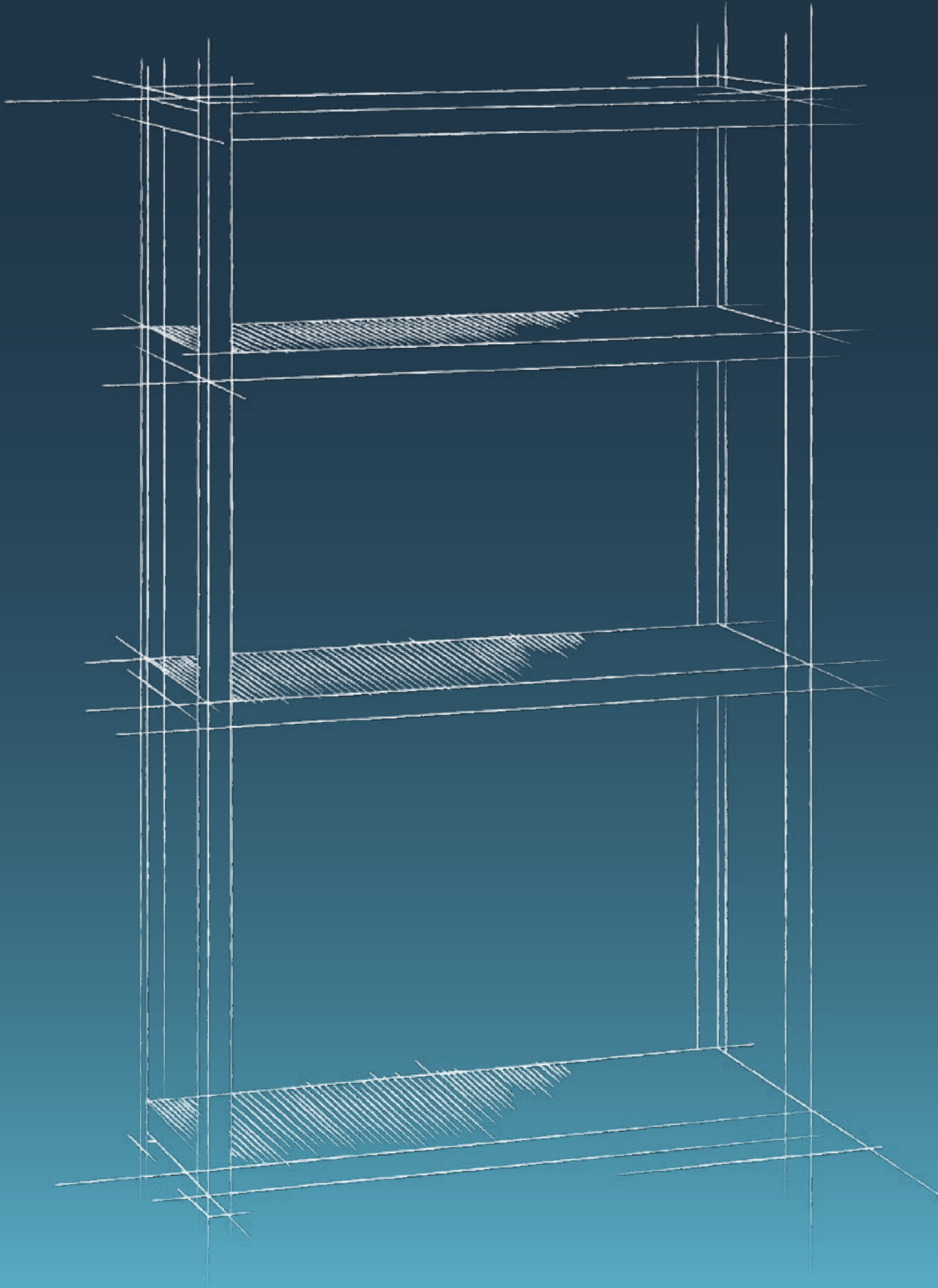

SHELVING

Wall-mounted shelving **P. 110**

Freestanding stainless steel shelving unit **P. 113**

Freestanding aluminium shelving unit **P. 124**

SHELVING Wall-mounted

Wall-mounted shelving

- Made of AISI 304 stainless steel (18/10).
- Wall-mountable brackets with Ø8 mm drill holes.
- Screws and plugs for installation are included.
- Comes fully welded.



Total dimensions (mm)	Code
600 x 400 x 250	• F0100217
800 x 400 x 250	• F0100218
1000 x 400 x 250	• F0100211
1200 x 400 x 250	• F0100212
1400 x 400 x 250	• F0100213
1500 x 400 x 250	• F0100219
1600 x 400 x 250	• F0100214
1800 x 400 x 250	• F0100215
2000 x 400 x 250	• F0100216



- **Customizable length available:**
Please indicate the desired length;
Price and code of the upper model.



Total dimensions (mm)	Code
600 x 250 x 150	• F0100207
800 x 250 x 150	• F0100208
1000 x 250 x 150	• F0100201
1200 x 250 x 150	• F0100202
1400 x 250 x 150	• F0100203
1500 x 250 x 150	• F0100209
1600 x 250 x 150	• F0100204
1800 x 250 x 150	• F0100205
2000 x 250 x 150	• F0100206

Shelving with brackets

- Shelving unit made of stainless steel.
- Screws and plugs for installation are included.
- Comes fully welded with disassembled brackets.



- **Customizable length available:**
Please indicate the desired length;
Price and code of the upper model.

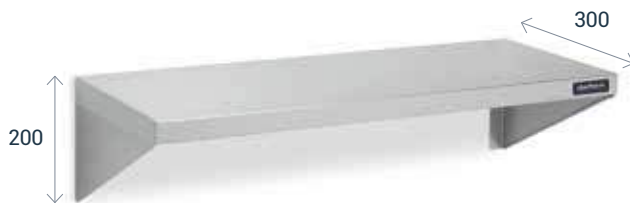

Total dimensions (mm)	Code
600 x 300 x 200	• F0100221
800 x 300 x 200	• F0100222
1000 x 300 x 200	• F0100223
1200 x 300 x 200	• F0100224
1400 x 300 x 200	• F0100225

Microwave shelf

- **Designed to hold microwaves or other appliances, hung from a wall.**
- Made of stainless steel.
- Wall-mountable brackets with Ø8 mm drill holes.
- Screws and plugs for installation are included.
- Ø60 mm hole for wiring.
- Comes fully welded with disassembled brackets.



- **Customizable length available:**
Please indicate the desired length;
Price and code of the upper model.



Total dimensions (mm)	Code
600 x 400 x 230	• F0200401
700 x 500 x 280	• F0200403
800 x 400 x 230	• F0200402

• 24-hour shipping

• 3-day shipping

Wall-mounted dish rack shelf

- Made of AISI 304 stainless steel (18/10).
- Wall-mountable brackets with Ø8 mm drill holes.
- Screws and plugs for installation are included.
- Removable stainless steel racks
- For plates with a maximum diameter of 250 mm.
- Comes fully welded.



Total dimensions (mm)	Plate capacity	Code
710 x 300 x 180	26	• F0200301
1430 x 300 x 180	52	• F0200302

Wall-mounted hood shelf

- Made of AISI 304 stainless steel (18/10).
- Wall-mountable brackets with Ø8 mm drill holes.
- Screws and plugs for installation are included.
- Removable stainless steel grill racks for GN 1/1
- Comes fully welded.



Total dimensions (mm)	Capacity	Code
590 x 400 x 180	1GN 1/1	• F0200104
1115 x 400 x 180	2GN 1/1	• F0200101
1650 x 400 x 180	3GN 1/1	• F0200102
2180 x 400 x 180	4GN 1/1	• F0200103

Wall-mounted tube shelving

- Made of AISI 304 stainless steel (18/10).
- Wall-mountable brushed stainless steel brackets with Ø 8 mm pre-drilled holes.
- Screws and plugs for installation are included.
- 25 x 25 mm stainless steel tubes
- Comes fully welded.

- **Customizable length available:**
Please indicate the desired length;
Price and code of the upper model.



Total dimensions (mm)	Code
600 x 400 x 248	• F0100007
800 x 400 x 248	• F0100008
1000 x 400 x 248	• F0100001
1200 x 400 x 248	• F0100002
1400 x 400 x 248	• F0100003
1600 x 400 x 248	• F0100004
1800 x 400 x 248	• F0100006 *
2000 x 400 x 248	• F0100005 *

* Units that have a welded central bracket.

Hanging rack

- Made of Ø30mm AISI 304 stainless steel (18/10) tube.
- Welded plates with holes for wall installation.
- Screws and plugs for installation are included.
- Comes fully welded.



Total dimensions (mm)	Code
1000 x 150	• F0210001
1500 x 150	• F0210002
2000 x 150	• F0210003

• 24-hour shipping

• 3-day shipping

SHELVING Wall-mounted

Adjustable wall-mounted shelving

- Made entirely of AISI grade 304 brushed stainless steel (18/10).
- Easy to install tracks.
- Screws and plugs for installation are included.



Tracks

Height (mm)	Code
600	• F0120001
1000	• F0120002
1500	• F0120003

- Price per unit.

Flat shelf

Dimensions (mm)	Code
1000 x 250	• F0100401
1200 x 250	• F0100403
1400 x 250	• F0100402
1600 x 250	• F0100404
1000 x 400	• F0100411
1200 x 400	• F0100413
1400 x 400	• F0100412
1600 x 400	• F0100414

Slanted shelf

Dimensions (mm)	Units	Containers	Code
1000 x 250	4	1/6	• F0100501
1000 x 400	4	1/3	• F0100511

- Containers not included.



Gastronorm containers
Page 160



• 24-hour shipping

SHELVING

Freestanding stainless steel

Freestanding four-level shelving unit

- Made of AISI 304 stainless steel (18/10).
- Shelf height is adjustable in 150 mm increments.
- Shelves available with widths of 400 and 500 mm.
- Stands available with heights of 1700 and 2000 mm.
- Shelves are attached to stands using the hardware included.



Total dimensions (mm)	Code
1000 x 400 x 1700	• KD104017
1200 x 400 x 1700	• KD124017
1400 x 400 x 1700	• KD144017
1000 x 400 x 2000	• KD104020
1200 x 400 x 2000	• KD124020
1400 x 400 x 2000	• KD144020
1000 x 500 x 1700	• KD105017
1200 x 500 x 1700	• KD125017
1400 x 500 x 1700	• KD145017
1000 x 500 x 2000	• KD105020
1200 x 500 x 2000	• KD125020
1400 x 500 x 2000	• KD145020

Extra shelf

Total dimensions (mm)	Code
1000 x 400	• KDE10040
1200 x 400	• KDE12040
1400 x 400	• KDE14040
1000 x 500	• KDE10050
1200 x 500	• KDE12050
1400 x 500	• KDE14050



• 24-hour shipping

SHELVING

Freestanding stainless steel

Freestanding stainless steel shelving unit

- Made of stainless steel.
- Shelf height is adjustable in 160 mm increments, with 11 possible levels.
- 2 shelf depths are available: 400 and 500 mm.
- Shelving unit height available: 1800 mm.
- Trays come in smooth, perforated, or polypropylene options.
- Removable trays for easy cleaning.
- Adjustable legs ensure maximum stability on any surface.
- Designed for easily assembly - no tools required.
- Maximum load per shelf: 170 kg.



• Designed for easily assembly - no tools required.

Supports

- Made of 30 x 30 mm stainless steel tube with adjustable feet.

Center support

Total dimensions (mm)	Code
1800 x 400	• KCC01840
1800 x 500	• KCC01850

Side support

Total dimensions (mm)	Code
1800 x 400	• KCL01840
1800 x 500	• KCL01850



Corner piece

- Accessory made of AISI 304 stainless steel (18/10) to mount corner shelving.

Dimensions (mm)	Code
400	• KA000400
500	• KA000500



• 24-hour shipping

Shelves with trays



• Polypropylene trays



• Smooth stainless steel trays



• Perforated stainless steel trays

400 mm Depth

Dimensions (mm)	Polypropylene trays	Smooth stainless steel trays	Perforated stainless steel trays
600 x 400	• K4060003	• K4060002	• K4060001
700 x 400	• K4070003	• K4070002	• K4070001
800 x 400	• K4080003	• K4080002	• K4080001
900 x 400	• K4090003	• K4090002	• K4090001
1000 x 400	• K4100003	• K4100002	• K4100001
1100 x 400	• K4110003	• K4110002	• K4110001
1200 x 400	• K4120003	• K4120002	• K4120001
1300 x 400	• K4130003	• K4130002	• K4130001
1400 x 400	• K4140003	• K4140002	• K4140001
1500 x 400	• K4150003	• K4150002	• K4150001
1600 x 400	• K4160003	• K4160002	• K4160001

500 mm Depth

Dimensions (mm)	Trays made of polypropylene	Smooth stainless steel trays	Perforated stainless steel trays
600 x 500	• K5060003	• K5060002	• K5060001
700 x 500	• K5070003	• K5070002	• K5070001
800 x 500	• K5080003	• K5080002	• K5080001
900 x 500	• K5090003	• K5090002	• K5090001
1000 x 500	• K5100003	• K5100002	• K5100001
1100 x 500	• K5110003	• K5110002	• K5110001
1200 x 500	• K5120003	• K5120002	• K5120001
1300 x 500	• K5130003	• K5130002	• K5130001
1500 x 500	• K5140003	• K5140002	• K5140001
1500 x 500	• K5150003	• K5150002	• K5150001
1600 x 500	• K5160003	• K5160002	• K5160001

• 24-hour shipping

SHELVING

Freestanding stainless steel

Trays



Total dimensions (mm)	Polypropylene	Smooth stainless steel	Perforated stainless steel
300 x 400	• KP304003	• KP304002	• KP304001
400 x 400	• KP404003	• KP404002	• KP404001
300 x 500	• KP305003	• KP305002	• KP305001
400 x 500	• KP405003	• KP405002	• KP405001

Bench

• For storing boxes in places where sanitation standards prohibit direct contact with the floor.



Total dimensions (mm)	Polypropylene	Smooth stainless steel
1060 x 500 x 180	• KB106003	• KB106002
1260 x 500 x 180	• KB126003	• KB126002
1460 x 500 x 180	• KB146003	• KB146002
1660 x 500 x 180	• KB166003	• KB166002

Hanging rack

• Made of Ø30 mm AISI 304 stainless steel (18/10) tube.

Dimensions (mm)	Code
800	• KBC00800
900	• KBC00900
1000	• KBC01000
1100	• KBC01100
1200	• KBC01200
1300	• KBC01300
1400	• KBC01400
1500	• KBC01500
1600	• KBC01600



Castors

• Pack includes four Ø125 mm castors (2 with brakes).

Model	Code
Pack of 4 castors	• KRU00001



• 24-hour shipping

Basic options for modular shelving

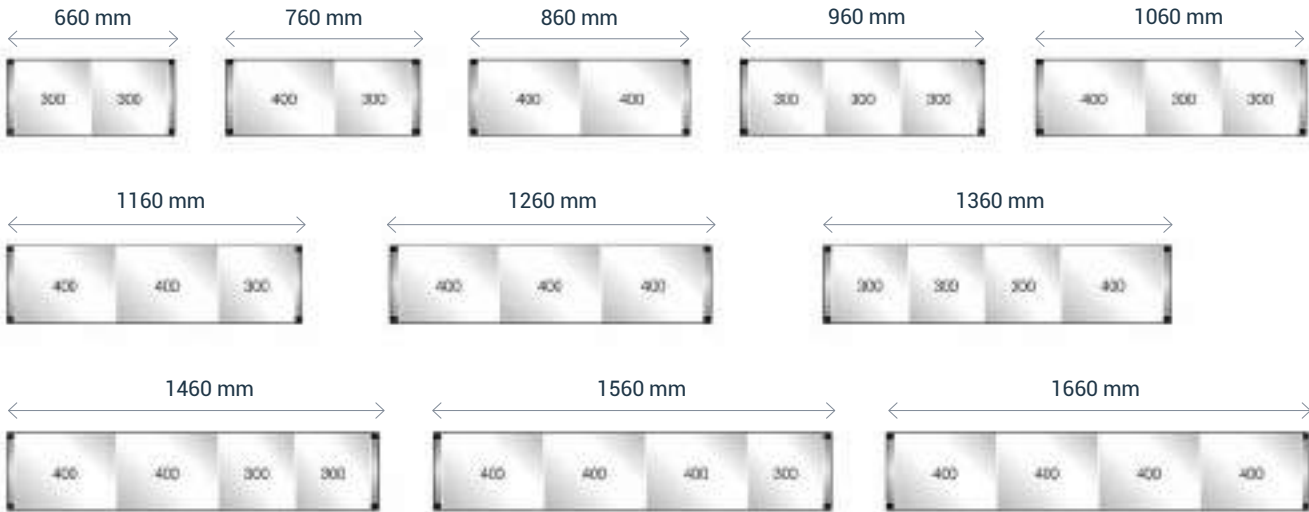

Example of a shelving order:

- To choose your modular shelving units, all you need to know is the dimensions of the room.
- Calculate the linear portion of the shelving unit based on the length of the room (X).
- To determine the length of the corner portion of the shelving unit, subtract the width of the linear shelving unit from the width of the room (Y). If the room has a safety radius, subtract it from the length of the room.

Example of how to calculate the estimate for a stainless steel and polypropylene corner shelving unit that is 400-mm-wide with four levels, in a 3000 x 2400 mm refrigerated chamber.

Refrigerated chamber	X=3000	Y=2400
Shelving 4 levels	linear (3000)	angular (2400-400=2000)
Code	KIT00087	KIT02077
Shelving dimensions	2990 mm	1960 mm

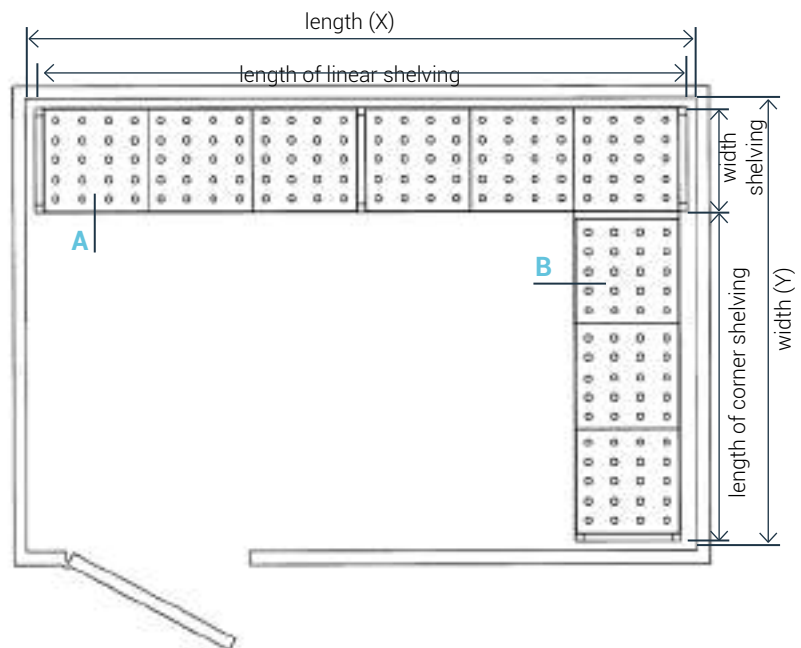

Linear shelving (A)



Corner shelving (B)



SHELVING

1800-mm-high linear sections



Stainless steel with polypropylene trays •

400 mm Depth

Length (mm)	3 Levels	4 Levels	5 Levels
660	KIT00001	KIT00063	KIT00125
760	KIT00002	KIT00064	KIT00126
860	KIT00003	KIT00065	KIT00127
960	KIT00004	KIT00066	KIT00128
1060	KIT00005	KIT00067	KIT00129
1160	KIT00006	KIT00068	KIT00130
1260	KIT00007	KIT00069	KIT00131
1360	KIT00008	KIT00070	KIT00132
1460	KIT00009	KIT00071	KIT00133
1560	KIT00010	KIT00072	KIT00134
1660	KIT00011	KIT00073	KIT00135
1690	KIT00012	KIT00074	KIT00136
1790	KIT00013	KIT00075	KIT00137
1890	KIT00014	KIT00076	KIT00138
1990	KIT00015	KIT00077	KIT00139
2090	KIT00016	KIT00078	KIT00140
2190	KIT00017	KIT00079	KIT00141
2290	KIT00018	KIT00080	KIT00142
2390	KIT00019	KIT00081	KIT00143
2490	KIT00020	KIT00082	KIT00144
2590	KIT00021	KIT00083	KIT00145
2690	KIT00022	KIT00084	KIT00146
2790	KIT00023	KIT00085	KIT00147
2890	KIT00024	KIT00086	KIT00148
2990	KIT00025	KIT00087	KIT00149
3090	KIT00026	KIT00088	KIT00150
3190	KIT00027	KIT00089	KIT00151
3290	KIT00028	KIT00090	KIT00152
3320	KIT00029	KIT00091	KIT00153
3420	KIT00030	KIT00092	KIT00154
3520	KIT00031	KIT00093	KIT00155
3620	KIT00032	KIT00094	KIT00156
3720	KIT00033	KIT00095	KIT00157
3820	KIT00034	KIT00096	KIT00158
3920	KIT00035	KIT00097	KIT00159
4020	KIT00036	KIT00098	KIT00160
4120	KIT00037	KIT00099	KIT00161
4220	KIT00038	KIT00100	KIT00162
4320	KIT00039	KIT00101	KIT00163
4420	KIT00040	KIT00102	KIT00164
4520	KIT00041	KIT00103	KIT00165
4620	KIT00042	KIT00104	KIT00166
4720	KIT00043	KIT00105	KIT00167
4820	KIT00044	KIT00106	KIT00168
4920	KIT00045	KIT00107	KIT00169
4950	KIT00046	KIT00108	KIT00170
5050	KIT00047	KIT00109	KIT00171
5150	KIT00048	KIT00110	KIT00172
5250	KIT00049	KIT00111	KIT00173
5350	KIT00050	KIT00112	KIT00174
5450	KIT00051	KIT00113	KIT00175
5550	KIT00052	KIT00114	KIT00176
5650	KIT00053	KIT00115	KIT00177
5750	KIT00054	KIT00116	KIT00178
5850	KIT00055	KIT00117	KIT00179
5950	KIT00056	KIT00118	KIT00180
6050	KIT00057	KIT00119	KIT00181
6150	KIT00058	KIT00120	KIT00182
6250	KIT00059	KIT00121	KIT00183
6350	KIT00060	KIT00122	KIT00184
6450	KIT00061	KIT00123	KIT00185
6550	KIT00062	KIT00124	KIT00186

500 mm Depth

Length (mm)	3 Levels	4 Levels	5 Levels
660	KIT00187	KIT00249	KIT00311
760	KIT00188	KIT00250	KIT00312
860	KIT00189	KIT00251	KIT00313
960	KIT00190	KIT00252	KIT00314
1060	KIT00191	KIT00253	KIT00315
1160	KIT00192	KIT00254	KIT00316
1260	KIT00193	KIT00255	KIT00317
1360	KIT00194	KIT00256	KIT00318
1460	KIT00195	KIT00257	KIT00319
1560	KIT00196	KIT00258	KIT00320
1660	KIT00197	KIT00259	KIT00321
1690	KIT00198	KIT00260	KIT00322
1790	KIT00199	KIT00261	KIT00323
1890	KIT00200	KIT00262	KIT00324
1990	KIT00201	KIT00263	KIT00325
2090	KIT00202	KIT00264	KIT00326
2190	KIT00203	KIT00265	KIT00327
2290	KIT00204	KIT00266	KIT00328
2390	KIT00205	KIT00267	KIT00329
2490	KIT00206	KIT00268	KIT00330
2590	KIT00207	KIT00269	KIT00331
2690	KIT00208	KIT00270	KIT00332
2790	KIT00209	KIT00271	KIT00333
2890	KIT00210	KIT00272	KIT00334
2990	KIT00211	KIT00273	KIT00335
3090	KIT00212	KIT00274	KIT00336
3190	KIT00213	KIT00275	KIT00337
3290	KIT00214	KIT00276	KIT00338
3320	KIT00215	KIT00277	KIT00339
3420	KIT00216	KIT00278	KIT00340
3520	KIT00217	KIT00279	KIT00341
3620	KIT00218	KIT00280	KIT00342
3720	KIT00219	KIT00281	KIT00343
3820	KIT00220	KIT00282	KIT00344
3920	KIT00221	KIT00283	KIT00345
4020	KIT00222	KIT00284	KIT00346
4120	KIT00223	KIT00285	KIT00347
4220	KIT00224	KIT00286	KIT00348
4320	KIT00225	KIT00287	KIT00349
4420	KIT00226	KIT00288	KIT00350
4520	KIT00227	KIT00289	KIT00351
4620	KIT00228	KIT00290	KIT00352
4720	KIT00229	KIT00291	KIT00353
4820	KIT00230	KIT00292	KIT00354
4920	KIT00231	KIT00293	KIT00355
4950	KIT00232	KIT00294	KIT00356
5050	KIT00233	KIT00295	KIT00357
5150	KIT00234	KIT00296	KIT00358
5250	KIT00235	KIT00297	KIT00359
5350	KIT00236	KIT00298	KIT00360
5450	KIT00237	KIT00299	KIT00361
5550	KIT00238	KIT00300	KIT00362
5650	KIT00239	KIT00301	KIT00363
5750	KIT00240	KIT00302	KIT00364
5850	KIT00241	KIT00303	KIT00365
5950	KIT00242	KIT00304	KIT00366
6050	KIT00243	KIT00305	KIT00367
6150	KIT00244	KIT00306	KIT00368
6250	KIT00245	KIT00307	KIT00369
6350	KIT00246	KIT00308	KIT00370
6450	KIT00247	KIT00309	KIT00371
6550	KIT00248	KIT00310	KIT00372

• 24-hour shipping

SHELVING

1800 mm angular sections



Stainless steel with polypropylene trays •

400 mm Depth

Length (mm)	3 Levels	4 Levels	5 Levels
630	KIT02001	KIT02063	KIT02125
730	KIT02002	KIT02064	KIT02126
830	KIT02003	KIT02065	KIT02127
930	KIT02004	KIT02066	KIT02128
1030	KIT02005	KIT02067	KIT02129
1130	KIT02006	KIT02068	KIT02130
1230	KIT02007	KIT02069	KIT02131
1330	KIT02008	KIT02070	KIT02132
1430	KIT02009	KIT02071	KIT02133
1530	KIT02010	KIT02072	KIT02134
1630	KIT02011	KIT02073	KIT02135
1660	KIT02012	KIT02074	KIT02136
1760	KIT02013	KIT02075	KIT02137
1860	KIT02014	KIT02076	KIT02138
1960	KIT02015	KIT02077	KIT02139
2060	KIT02016	KIT02078	KIT02140
2160	KIT02017	KIT02079	KIT02141
2260	KIT02018	KIT02080	KIT02142
2360	KIT02019	KIT02081	KIT02143
2460	KIT02020	KIT02082	KIT02144
2560	KIT02021	KIT02083	KIT02145
2660	KIT02022	KIT02084	KIT02146
2760	KIT02023	KIT02085	KIT02147
2860	KIT02024	KIT02086	KIT02148
2960	KIT02025	KIT02087	KIT02149
3060	KIT02026	KIT02088	KIT02150
3160	KIT02027	KIT02089	KIT02151
3260	KIT02028	KIT02090	KIT02152
3290	KIT02029	KIT02091	KIT02153
3390	KIT02030	KIT02092	KIT02154
3490	KIT02031	KIT02093	KIT02155
3590	KIT02032	KIT02094	KIT02156
3690	KIT02033	KIT02095	KIT02157
3790	KIT02034	KIT02096	KIT02158
3890	KIT02035	KIT02097	KIT02159
3990	KIT02036	KIT02098	KIT02160
4090	KIT02037	KIT02099	KIT02161
4190	KIT02038	KIT02100	KIT02162
4290	KIT02039	KIT02101	KIT02163
4390	KIT02040	KIT02102	KIT02164
4490	KIT02041	KIT02103	KIT02165
4590	KIT02042	KIT02104	KIT02166
4690	KIT02043	KIT02105	KIT02167
4790	KIT02044	KIT02106	KIT02168
4890	KIT02045	KIT02107	KIT02169
4920	KIT02046	KIT02108	KIT02170
5020	KIT02047	KIT02109	KIT02171
5120	KIT02048	KIT02110	KIT02172
5220	KIT02049	KIT02111	KIT02173
5320	KIT02050	KIT02112	KIT02174
5420	KIT02051	KIT02113	KIT02175
5520	KIT02052	KIT02114	KIT02176
5620	KIT02053	KIT02115	KIT02177
5720	KIT02054	KIT02116	KIT02178
5820	KIT02055	KIT02117	KIT02179
5920	KIT02056	KIT02118	KIT02180
6020	KIT02057	KIT02119	KIT02181
6120	KIT02058	KIT02120	KIT02182
6220	KIT02059	KIT02121	KIT02183
6320	KIT02060	KIT02122	KIT02184
6420	KIT02061	KIT02123	KIT02185
6520	KIT02062	KIT02124	KIT02186

500 mm Depth

Length (mm)	3 Levels	4 Levels	5 Levels
630	KIT02187	KIT02249	KIT02311
730	KIT02188	KIT02250	KIT02312
830	KIT02189	KIT02251	KIT02313
930	KIT02190	KIT02252	KIT02314
1030	KIT02191	KIT02253	KIT02315
1130	KIT02192	KIT02254	KIT02316
1230	KIT02193	KIT02255	KIT02317
1330	KIT02194	KIT02256	KIT02318
1430	KIT02195	KIT02257	KIT02319
1530	KIT02196	KIT02258	KIT02320
1630	KIT02197	KIT02259	KIT02321
1660	KIT02198	KIT02260	KIT02322
1760	KIT02199	KIT02261	KIT02323
1860	KIT02200	KIT02262	KIT02324
1960	KIT02201	KIT02263	KIT02325
2060	KIT02202	KIT02264	KIT02326
2160	KIT02203	KIT02265	KIT02327
2260	KIT02204	KIT02266	KIT02328
2360	KIT02205	KIT02267	KIT02329
2460	KIT02206	KIT02268	KIT02330
2560	KIT02207	KIT02269	KIT02331
2660	KIT02208	KIT02270	KIT02332
2760	KIT02209	KIT02271	KIT02333
2860	KIT02210	KIT02272	KIT02334
2960	KIT02211	KIT02273	KIT02335
3060	KIT02212	KIT02274	KIT02336
3160	KIT02213	KIT02275	KIT02337
3260	KIT02214	KIT02276	KIT02338
3290	KIT02215	KIT02277	KIT02339
3390	KIT02216	KIT02278	KIT02340
3490	KIT02217	KIT02279	KIT02341
3590	KIT02218	KIT02280	KIT02342
3690	KIT02219	KIT02281	KIT02343
3790	KIT02220	KIT02282	KIT02344
3890	KIT02221	KIT02283	KIT02345
3990	KIT02222	KIT02284	KIT02346
4090	KIT02223	KIT02285	KIT02347
4190	KIT02224	KIT02286	KIT02348
4290	KIT02225	KIT02287	KIT02349
4390	KIT02226	KIT02288	KIT02350
4490	KIT02227	KIT02289	KIT02351
4590	KIT02228	KIT02290	KIT02352
4690	KIT02229	KIT02291	KIT02353
4790	KIT02230	KIT02292	KIT02354
4890	KIT02231	KIT02293	KIT02355
4920	KIT02232	KIT02294	KIT02356
5020	KIT02233	KIT02295	KIT02357
5120	KIT02234	KIT02296	KIT02358
5220	KIT02235	KIT02297	KIT02359
5320	KIT02236	KIT02298	KIT02360
5420	KIT02237	KIT02299	KIT02361
5520	KIT02238	KIT02300	KIT02362
5620	KIT02239	KIT02301	KIT02363
5720	KIT02240	KIT02302	KIT02364
5820	KIT02241	KIT02303	KIT02365
5920	KIT02242	KIT02304	KIT02366
6020	KIT02243	KIT02305	KIT02367
6120	KIT02244	KIT02306	KIT02368
6220	KIT02245	KIT02307	KIT02369
6320	KIT02246	KIT02308	KIT02370
6420	KIT02247	KIT02309	KIT02371
6520	KIT02248	KIT02310	KIT02372

• 24-hour shipping

SHELVING

1800-mm-high linear sections



Stainless steel with smooth stainless steel trays .

400 mm Depth

Length (mm)	3 Levels	4 Levels	5 Levels
660	KIT00373	KIT00435	KIT00497
760	KIT00374	KIT00436	KIT00498
860	KIT00375	KIT00437	KIT00499
960	KIT00376	KIT00438	KIT00500
1060	KIT00377	KIT00439	KIT00501
1160	KIT00378	KIT00440	KIT00502
1260	KIT00379	KIT00441	KIT00503
1360	KIT00380	KIT00442	KIT00504
1460	KIT00381	KIT00443	KIT00505
1560	KIT00382	KIT00444	KIT00506
1660	KIT00383	KIT00445	KIT00507
1690	KIT00384	KIT00446	KIT00508
1790	KIT00385	KIT00447	KIT00509
1890	KIT00386	KIT00448	KIT00510
1990	KIT00387	KIT00449	KIT00511
2090	KIT00388	KIT00450	KIT00512
2190	KIT00389	KIT00451	KIT00513
2290	KIT00390	KIT00452	KIT00514
2390	KIT00391	KIT00453	KIT00515
2490	KIT00392	KIT00454	KIT00516
2590	KIT00393	KIT00455	KIT00517
2690	KIT00394	KIT00456	KIT00518
2790	KIT00395	KIT00457	KIT00519
2890	KIT00396	KIT00458	KIT00520
2990	KIT00397	KIT00459	KIT00521
3090	KIT00398	KIT00460	KIT00522
3190	KIT00399	KIT00461	KIT00523
3290	KIT00400	KIT00462	KIT00524
3320	KIT00401	KIT00463	KIT00525
3420	KIT00402	KIT00464	KIT00526
3520	KIT00403	KIT00465	KIT00527
3620	KIT00404	KIT00466	KIT00528
3720	KIT00405	KIT00467	KIT00529
3820	KIT00406	KIT00468	KIT00530
3920	KIT00407	KIT00469	KIT00531
4020	KIT00408	KIT00470	KIT00532
4120	KIT00409	KIT00471	KIT00533
4220	KIT00410	KIT00472	KIT00534
4320	KIT00411	KIT00473	KIT00535
4420	KIT00412	KIT00474	KIT00536
4520	KIT00413	KIT00475	KIT00537
4620	KIT00414	KIT00476	KIT00538
4720	KIT00415	KIT00477	KIT00539
4820	KIT00416	KIT00478	KIT00540
4920	KIT00417	KIT00479	KIT00541
4950	KIT00418	KIT00480	KIT00542
5050	KIT00419	KIT00481	KIT00543
5150	KIT00420	KIT00482	KIT00544
5250	KIT00421	KIT00483	KIT00545
5350	KIT00422	KIT00484	KIT00546
5450	KIT00423	KIT00485	KIT00547
5550	KIT00424	KIT00486	KIT00548
5650	KIT00425	KIT00487	KIT00549
5750	KIT00426	KIT00488	KIT00550
5850	KIT00427	KIT00489	KIT00551
5950	KIT00428	KIT00490	KIT00552
6050	KIT00429	KIT00491	KIT00553
6150	KIT00430	KIT00492	KIT00554
6250	KIT00431	KIT00493	KIT00555
6350	KIT00432	KIT00494	KIT00556
6450	KIT00433	KIT00495	KIT00557
6550	KIT00434	KIT00496	KIT00558

500 mm Depth

Length (mm)	3 Levels	4 Levels	5 Levels
660	KIT00559	KIT00621	KIT00683
760	KIT00560	KIT00622	KIT00684
860	KIT00561	KIT00623	KIT00685
960	KIT00562	KIT00624	KIT00686
1060	KIT00563	KIT00625	KIT00687
1160	KIT00564	KIT00626	KIT00688
1260	KIT00565	KIT00627	KIT00689
1360	KIT00566	KIT00628	KIT00690
1460	KIT00567	KIT00629	KIT00691
1560	KIT00568	KIT00630	KIT00692
1660	KIT00569	KIT00631	KIT00693
1690	KIT00570	KIT00632	KIT00694
1790	KIT00571	KIT00633	KIT00695
1890	KIT00572	KIT00634	KIT00696
1990	KIT00573	KIT00635	KIT00697
2090	KIT00574	KIT00636	KIT00698
2190	KIT00575	KIT00637	KIT00699
2290	KIT00576	KIT00638	KIT00700
2390	KIT00577	KIT00639	KIT00701
2490	KIT00578	KIT00640	KIT00702
2590	KIT00579	KIT00641	KIT00703
2690	KIT00580	KIT00642	KIT00704
2790	KIT00581	KIT00643	KIT00705
2890	KIT00582	KIT00644	KIT00706
2990	KIT00583	KIT00645	KIT00707
3090	KIT00584	KIT00646	KIT00708
3190	KIT00585	KIT00647	KIT00709
3290	KIT00586	KIT00648	KIT00710
3320	KIT00587	KIT00649	KIT00711
3420	KIT00588	KIT00650	KIT00712
3520	KIT00589	KIT00651	KIT00713
3620	KIT00590	KIT00652	KIT00714
3720	KIT00591	KIT00653	KIT00715
3820	KIT00592	KIT00654	KIT00716
3920	KIT00593	KIT00655	KIT00717
4020	KIT00594	KIT00656	KIT00718
4120	KIT00595	KIT00657	KIT00719
4220	KIT00596	KIT00658	KIT00720
4320	KIT00597	KIT00659	KIT00721
4420	KIT00598	KIT00660	KIT00722
4520	KIT00599	KIT00661	KIT00723
4620	KIT00600	KIT00662	KIT00724
4720	KIT00601	KIT00663	KIT00725
4820	KIT00602	KIT00664	KIT00726
4920	KIT00603	KIT00665	KIT00727
4950	KIT00604	KIT00666	KIT00728
5050	KIT00605	KIT00667	KIT00729
5150	KIT00606	KIT00668	KIT00730
5250	KIT00607	KIT00669	KIT00731
5350	KIT00608	KIT00670	KIT00732
5450	KIT00609	KIT00671	KIT00733
5550	KIT00610	KIT00672	KIT00734
5650	KIT00611	KIT00673	KIT00735
5750	KIT00612	KIT00674	KIT00736
5850	KIT00613	KIT00675	KIT00737
5950	KIT00614	KIT00676	KIT00738
6050	KIT00615	KIT00677	KIT00739
6150	KIT00616	KIT00678	KIT00740
6250	KIT00617	KIT00679	KIT00741
6350	KIT00618	KIT00680	KIT00742
6450	KIT00619	KIT00681	KIT00743
6550	KIT00620	KIT00682	KIT00744

• 24-hour shipping

SHELVING

1800 mm angular sections



Stainless steel with smooth stainless steel trays .

400 mm Depth

Length (mm)	3 Levels	4 Levels	5 Levels
630	KIT02373	KIT02435	KIT02497
730	KIT02374	KIT02436	KIT02498
830	KIT02375	KIT02437	KIT02499
930	KIT02376	KIT02438	KIT02500
1030	KIT02377	KIT02439	KIT02501
1130	KIT02378	KIT02440	KIT02502
1230	KIT02379	KIT02441	KIT02503
1330	KIT02380	KIT02442	KIT02504
1430	KIT02381	KIT02443	KIT02505
1530	KIT02382	KIT02444	KIT02506
1630	KIT02383	KIT02445	KIT02507
1660	KIT02384	KIT02446	KIT02508
1760	KIT02385	KIT02447	KIT02509
1860	KIT02386	KIT02448	KIT02510
1960	KIT02387	KIT02449	KIT02511
2060	KIT02388	KIT02450	KIT02512
2160	KIT02389	KIT02451	KIT02513
2260	KIT02390	KIT02452	KIT02514
2360	KIT02391	KIT02453	KIT02515
2460	KIT02392	KIT02454	KIT02516
2560	KIT02393	KIT02455	KIT02517
2660	KIT02394	KIT02456	KIT02518
2760	KIT02395	KIT02457	KIT02519
2860	KIT02396	KIT02458	KIT02520
2960	KIT02397	KIT02459	KIT02521
3060	KIT02398	KIT02460	KIT02522
3160	KIT02399	KIT02461	KIT02523
3260	KIT02400	KIT02462	KIT02524
3290	KIT02401	KIT02463	KIT02525
3390	KIT02402	KIT02464	KIT02526
3490	KIT02403	KIT02465	KIT02527
3590	KIT02404	KIT02466	KIT02528
3690	KIT02405	KIT02467	KIT02529
3790	KIT02406	KIT02468	KIT02530
3890	KIT02407	KIT02469	KIT02531
3990	KIT02408	KIT02470	KIT02532
4090	KIT02409	KIT02471	KIT02533
4190	KIT02410	KIT02472	KIT02534
4290	KIT02411	KIT02473	KIT02535
4390	KIT02412	KIT02474	KIT02536
4490	KIT02413	KIT02475	KIT02537
4590	KIT02414	KIT02476	KIT02538
4690	KIT02415	KIT02477	KIT02539
4790	KIT02416	KIT02478	KIT02540
4890	KIT02417	KIT02479	KIT02541
4920	KIT02418	KIT02480	KIT02542
5020	KIT02419	KIT02481	KIT02543
5120	KIT02420	KIT02482	KIT02544
5220	KIT02421	KIT02483	KIT02545
5320	KIT02422	KIT02484	KIT02546
5420	KIT02423	KIT02485	KIT02547
5520	KIT02424	KIT02486	KIT02548
5620	KIT02425	KIT02487	KIT02549
5720	KIT02426	KIT02488	KIT02550
5820	KIT02427	KIT02489	KIT02551
5920	KIT02428	KIT02490	KIT02552
6020	KIT02429	KIT02491	KIT02553
6120	KIT02430	KIT02492	KIT02554
6220	KIT02431	KIT02493	KIT02555
6320	KIT02432	KIT02494	KIT02556
6420	KIT02433	KIT02495	KIT02557
6520	KIT02434	KIT02496	KIT02558

500 mm Depth

Length (mm)	3 Levels	4 Levels	5 Levels
630	KIT02559	KIT02621	KIT02683
730	KIT02560	KIT02622	KIT02684
830	KIT02561	KIT02623	KIT02685
930	KIT02562	KIT02624	KIT02686
1030	KIT02563	KIT02625	KIT02687
1130	KIT02564	KIT02626	KIT02688
1230	KIT02565	KIT02627	KIT02689
1330	KIT02566	KIT02628	KIT02690
1430	KIT02567	KIT02629	KIT02691
1530	KIT02568	KIT02630	KIT02692
1630	KIT02569	KIT02631	KIT02693
1660	KIT02570	KIT02632	KIT02694
1760	KIT02571	KIT02633	KIT02695
1860	KIT02572	KIT02634	KIT02696
1960	KIT02573	KIT02635	KIT02697
2060	KIT02574	KIT02636	KIT02698
2160	KIT02575	KIT02637	KIT02699
2260	KIT02576	KIT02638	KIT02700
2360	KIT02577	KIT02639	KIT02701
2460	KIT02578	KIT02640	KIT02702
2560	KIT02579	KIT02641	KIT02703
2660	KIT02580	KIT02642	KIT02704
2760	KIT02581	KIT02643	KIT02705
2860	KIT02582	KIT02644	KIT02706
2960	KIT02583	KIT02645	KIT02707
3060	KIT02584	KIT02646	KIT02708
3160	KIT02585	KIT02647	KIT02709
3260	KIT02586	KIT02648	KIT02710
3290	KIT02587	KIT02649	KIT02711
3390	KIT02588	KIT02650	KIT02712
3490	KIT02589	KIT02651	KIT02713
3590	KIT02590	KIT02652	KIT02714
3690	KIT02591	KIT02653	KIT02715
3790	KIT02592	KIT02654	KIT02716
3890	KIT02593	KIT02655	KIT02717
3990	KIT02594	KIT02656	KIT02718
4090	KIT02595	KIT02657	KIT02719
4190	KIT02596	KIT02658	KIT02720
4290	KIT02597	KIT02659	KIT02721
4390	KIT02598	KIT02660	KIT02722
4490	KIT02599	KIT02661	KIT02723
4590	KIT02600	KIT02662	KIT02724
4690	KIT02601	KIT02663	KIT02725
4790	KIT02602	KIT02664	KIT02726
4890	KIT02603	KIT02665	KIT02727
4920	KIT02604	KIT02666	KIT02728
5020	KIT02605	KIT02667	KIT02729
5120	KIT02606	KIT02668	KIT02730
5220	KIT02607	KIT02669	KIT02731
5320	KIT02608	KIT02670	KIT02732
5420	KIT02609	KIT02671	KIT02733
5520	KIT02610	KIT02672	KIT02734
5620	KIT02611	KIT02673	KIT02735
5720	KIT02612	KIT02674	KIT02736
5820	KIT02613	KIT02675	KIT02737
5920	KIT02614	KIT02676	KIT02738
6020	KIT02615	KIT02677	KIT02739
6120	KIT02616	KIT02678	KIT02740
6220	KIT02617	KIT02679	KIT02741
6320	KIT02618	KIT02680	KIT02742
6420	KIT02619	KIT02681	KIT02743
6520	KIT02620	KIT02682	KIT02744

• 24-hour shipping

SHELVING

1800-mm-high linear sections



Stainless steel with perforated stainless steel trays •

400 mm Depth

Length (mm)	3 Levels	4 Levels	5 Levels
660	KIT00745	KIT00807	KIT00869
760	KIT00746	KIT00808	KIT00870
860	KIT00747	KIT00809	KIT00871
960	KIT00748	KIT00810	KIT00872
1060	KIT00749	KIT00811	KIT00873
1160	KIT00750	KIT00812	KIT00874
1260	KIT00751	KIT00813	KIT00875
1360	KIT00752	KIT00814	KIT00876
1460	KIT00753	KIT00815	KIT00877
1560	KIT00754	KIT00816	KIT00878
1660	KIT00755	KIT00817	KIT00879
1690	KIT00756	KIT00818	KIT00880
1790	KIT00757	KIT00819	KIT00881
1890	KIT00758	KIT00820	KIT00882
1990	KIT00759	KIT00821	KIT00883
2090	KIT00760	KIT00822	KIT00884
2190	KIT00761	KIT00823	KIT00885
2290	KIT00762	KIT00824	KIT00886
2390	KIT00763	KIT00825	KIT00887
2490	KIT00764	KIT00826	KIT00888
2590	KIT00765	KIT00827	KIT00889
2690	KIT00766	KIT00828	KIT00890
2790	KIT00767	KIT00829	KIT00891
2890	KIT00768	KIT00830	KIT00892
2990	KIT00769	KIT00831	KIT00893
3090	KIT00770	KIT00832	KIT00894
3190	KIT00771	KIT00833	KIT00895
3290	KIT00772	KIT00834	KIT00896
3320	KIT00773	KIT00835	KIT00897
3420	KIT00774	KIT00836	KIT00898
3520	KIT00775	KIT00837	KIT00899
3620	KIT00776	KIT00838	KIT00900
3720	KIT00777	KIT00839	KIT00901
3820	KIT00778	KIT00840	KIT00902
3920	KIT00779	KIT00841	KIT00903
4020	KIT00780	KIT00842	KIT00904
4120	KIT00781	KIT00843	KIT00905
4220	KIT00782	KIT00844	KIT00906
4320	KIT00783	KIT00845	KIT00907
4420	KIT00784	KIT00846	KIT00908
4520	KIT00785	KIT00847	KIT00909
4620	KIT00786	KIT00848	KIT00910
4720	KIT00787	KIT00849	KIT00911
4820	KIT00788	KIT00850	KIT00912
4920	KIT00789	KIT00851	KIT00913
4950	KIT00790	KIT00852	KIT00914
5050	KIT00791	KIT00853	KIT00915
5150	KIT00792	KIT00854	KIT00916
5250	KIT00793	KIT00855	KIT00917
5350	KIT00794	KIT00856	KIT00918
5450	KIT00795	KIT00857	KIT00919
5550	KIT00796	KIT00858	KIT00920
5650	KIT00797	KIT00859	KIT00921
5750	KIT00798	KIT00860	KIT00922
5850	KIT00799	KIT00861	KIT00923
5950	KIT00800	KIT00862	KIT00924
6050	KIT00801	KIT00863	KIT00925
6150	KIT00802	KIT00864	KIT00926
6250	KIT00803	KIT00865	KIT00927
6350	KIT00804	KIT00866	KIT00928
6450	KIT00805	KIT00867	KIT00929
6550	KIT00806	KIT00868	KIT00930

500 mm Depth

Length (mm)	3 Levels	4 Levels	5 Levels
660	KIT00931	KIT00993	KIT01055
760	KIT00932	KIT00994	KIT01056
860	KIT00933	KIT00995	KIT01057
960	KIT00934	KIT00996	KIT01058
1060	KIT00935	KIT00997	KIT01059
1160	KIT00936	KIT00998	KIT01060
1260	KIT00937	KIT00999	KIT01061
1360	KIT00938	KIT01000	KIT01062
1460	KIT00939	KIT01001	KIT01063
1560	KIT00940	KIT01002	KIT01064
1660	KIT00941	KIT01003	KIT01065
1690	KIT00942	KIT01004	KIT01066
1790	KIT00943	KIT01005	KIT01067
1890	KIT00944	KIT01006	KIT01068
1990	KIT00945	KIT01007	KIT01069
2090	KIT00946	KIT01008	KIT01070
2190	KIT00947	KIT01009	KIT01071
2290	KIT00948	KIT01010	KIT01072
2390	KIT00949	KIT01011	KIT01073
2490	KIT00950	KIT01012	KIT01074
2590	KIT00951	KIT01013	KIT01075
2690	KIT00952	KIT01014	KIT01076
2790	KIT00953	KIT01015	KIT01077
2890	KIT00954	KIT01016	KIT01078
2990	KIT00955	KIT01017	KIT01079
3090	KIT00956	KIT01018	KIT01080
3190	KIT00957	KIT01019	KIT01081
3290	KIT00958	KIT01020	KIT01082
3320	KIT00959	KIT01021	KIT01083
3420	KIT00960	KIT01022	KIT01084
3520	KIT00961	KIT01023	KIT01085
3620	KIT00962	KIT01024	KIT01086
3720	KIT00963	KIT01025	KIT01087
3820	KIT00964	KIT01026	KIT01088
3920	KIT00965	KIT01027	KIT01089
4020	KIT00966	KIT01028	KIT01090
4120	KIT00967	KIT01029	KIT01091
4220	KIT00968	KIT01030	KIT01092
4320	KIT00969	KIT01031	KIT01093
4420	KIT00970	KIT01032	KIT01094
4520	KIT00971	KIT01033	KIT01095
4620	KIT00972	KIT01034	KIT01096
4720	KIT00973	KIT01035	KIT01097
4820	KIT00974	KIT01036	KIT01098
4920	KIT00975	KIT01037	KIT01099
4950	KIT00976	KIT01038	KIT01100
5050	KIT00977	KIT01039	KIT01101
5150	KIT00978	KIT01040	KIT01102
5250	KIT00979	KIT01041	KIT01103
5350	KIT00980	KIT01042	KIT01104
5450	KIT00981	KIT01043	KIT01105
5550	KIT00982	KIT01044	KIT01106
5650	KIT00983	KIT01045	KIT01107
5750	KIT00984	KIT01046	KIT01108
5850	KIT00985	KIT01047	KIT01109
5950	KIT00986	KIT01048	KIT01110
6050	KIT00987	KIT01049	KIT01111
6150	KIT00988	KIT01050	KIT01112
6250	KIT00989	KIT01051	KIT01113
6350	KIT00990	KIT01052	KIT01114
6450	KIT00991	KIT01053	KIT01115
6550	KIT00992	KIT01054	KIT01116

• 24-hour shipping

SHELVING

1800 mm angular sections



Stainless steel with perforated stainless steel trays .

400 mm Depth

Length (mm)	3 Levels	4 Levels	5 Levels
630	KIT02745	KIT02807	KIT02869
730	KIT02746	KIT02808	KIT02870
830	KIT02747	KIT02809	KIT02871
930	KIT02748	KIT02810	KIT02872
1030	KIT02749	KIT02811	KIT02873
1130	KIT02750	KIT02812	KIT02874
1230	KIT02751	KIT02813	KIT02875
1330	KIT02752	KIT02814	KIT02876
1430	KIT02753	KIT02815	KIT02877
1530	KIT02754	KIT02816	KIT02878
1630	KIT02755	KIT02817	KIT02879
1660	KIT02756	KIT02818	KIT02880
1760	KIT02757	KIT02819	KIT02881
1860	KIT02758	KIT02820	KIT02882
1960	KIT02759	KIT02821	KIT02883
2060	KIT02760	KIT02822	KIT02884
2160	KIT02761	KIT02823	KIT02885
2260	KIT02762	KIT02824	KIT02886
2360	KIT02763	KIT02825	KIT02887
2460	KIT02764	KIT02826	KIT02888
2560	KIT02765	KIT02827	KIT02889
2660	KIT02766	KIT02828	KIT02890
2760	KIT02767	KIT02829	KIT02891
2860	KIT02768	KIT02830	KIT02892
2960	KIT02769	KIT02831	KIT02893
3060	KIT02770	KIT02832	KIT02894
3160	KIT02771	KIT02833	KIT02895
3260	KIT02772	KIT02834	KIT02896
3290	KIT02773	KIT02835	KIT02897
3390	KIT02774	KIT02836	KIT02898
3490	KIT02775	KIT02837	KIT02899
3590	KIT02776	KIT02838	KIT02900
3690	KIT02777	KIT02839	KIT02901
3790	KIT02778	KIT02840	KIT02902
3890	KIT02779	KIT02841	KIT02903
3990	KIT02780	KIT02842	KIT02904
4090	KIT02781	KIT02843	KIT02905
4190	KIT02782	KIT02844	KIT02906
4290	KIT02783	KIT02845	KIT02907
4390	KIT02784	KIT02846	KIT02908
4490	KIT02785	KIT02847	KIT02909
4590	KIT02786	KIT02848	KIT02910
4690	KIT02787	KIT02849	KIT02911
4790	KIT02788	KIT02850	KIT02912
4890	KIT02789	KIT02851	KIT02913
4920	KIT02790	KIT02852	KIT02914
5020	KIT02791	KIT02853	KIT02915
5120	KIT02792	KIT02854	KIT02916
5220	KIT02793	KIT02855	KIT02917
5320	KIT02794	KIT02856	KIT02918
5420	KIT02795	KIT02857	KIT02919
5520	KIT02796	KIT02858	KIT02920
5620	KIT02797	KIT02859	KIT02921
5720	KIT02798	KIT02860	KIT02922
5820	KIT02799	KIT02861	KIT02923
5920	KIT02800	KIT02862	KIT02924
6020	KIT02801	KIT02863	KIT02925
6120	KIT02802	KIT02864	KIT02926
6220	KIT02803	KIT02865	KIT02927
6320	KIT02804	KIT02866	KIT02928
6420	KIT02805	KIT02867	KIT02929
6520	KIT02806	KIT02868	KIT02930

500 mm Depth

Length (mm)	3 Levels	4 Levels	5 Levels
630	KIT02931	KIT02993	KIT03055
730	KIT02932	KIT02994	KIT03056
830	KIT02933	KIT02995	KIT03057
930	KIT02934	KIT02996	KIT03058
1030	KIT02935	KIT02997	KIT03059
1130	KIT02936	KIT02998	KIT03060
1230	KIT02937	KIT02999	KIT03061
1330	KIT02938	KIT03000	KIT03062
1430	KIT02939	KIT03001	KIT03063
1530	KIT02940	KIT03002	KIT03064
1630	KIT02941	KIT03003	KIT03065
1660	KIT02942	KIT03004	KIT03066
1760	KIT02943	KIT03005	KIT03067
1860	KIT02944	KIT03006	KIT03068
1960	KIT02945	KIT03007	KIT03069
2060	KIT02946	KIT03008	KIT03070
2160	KIT02947	KIT03009	KIT03071
2260	KIT02948	KIT03010	KIT03072
2360	KIT02949	KIT03011	KIT03073
2460	KIT02950	KIT03012	KIT03074
2560	KIT02951	KIT03013	KIT03075
2660	KIT02952	KIT03014	KIT03076
2760	KIT02953	KIT03015	KIT03077
2860	KIT02954	KIT03016	KIT03078
2960	KIT02955	KIT03017	KIT03079
3060	KIT02956	KIT03018	KIT03080
3160	KIT02957	KIT03019	KIT03081
3260	KIT02958	KIT03020	KIT03082
3290	KIT02959	KIT03021	KIT03083
3390	KIT02960	KIT03022	KIT03084
3490	KIT02961	KIT03023	KIT03085
3590	KIT02962	KIT03024	KIT03086
3690	KIT02963	KIT03025	KIT03087
3790	KIT02964	KIT03026	KIT03088
3890	KIT02965	KIT03027	KIT03089
3990	KIT02966	KIT03028	KIT03090
4090	KIT02967	KIT03029	KIT03091
4190	KIT02968	KIT03030	KIT03092
4290	KIT02969	KIT03031	KIT03093
4390	KIT02970	KIT03032	KIT03094
4490	KIT02971	KIT03033	KIT03095
4590	KIT02972	KIT03034	KIT03096
4690	KIT02973	KIT03035	KIT03097
4790	KIT02974	KIT03036	KIT03098
4890	KIT02975	KIT03037	KIT03099
4920	KIT02976	KIT03038	KIT03100
5020	KIT02977	KIT03039	KIT03101
5120	KIT02978	KIT03040	KIT03102
5220	KIT02979	KIT03041	KIT03103
5320	KIT02980	KIT03042	KIT03104
5420	KIT02981	KIT03043	KIT03105
5520	KIT02982	KIT03044	KIT03106
5620	KIT02983	KIT03045	KIT03107
5720	KIT02984	KIT03046	KIT03108
5820	KIT02985	KIT03047	KIT03109
5920	KIT02986	KIT03048	KIT03110
6020	KIT02987	KIT03049	KIT03111
6120	KIT02988	KIT03050	KIT03112
6220	KIT02989	KIT03051	KIT03113
6320	KIT02990	KIT03052	KIT03114
6420	KIT02991	KIT03053	KIT03115
6520	KIT02992	KIT03054	KIT03116

• 24-hour shipping

SHELVING

Freestanding aluminium

Freestanding aluminium shelving unit

- **Specially designed to be placed in refrigerated chambers.**
- Easy assembly with fasteners.
- Sturdy 20 micron aluminium structure.
- If weight is spread uniformly, each shelf has a 150 kg capacity.
- Shelf height is adjustable in 150mm increments.
- Self-ventilating, detachable, dishwasher-safe polypropylene grills
- 2 depths: 370 and 570mm Gastronorm sizes.
- 2 shelving unit heights: 1700 and 2000 mm.
- The screw-free fastener assembly system allows you to save time during installation.



• Detail of the mounting piece

Diagram of the different combinations of shelf width.
 These shelving units have 10 different shelf lengths for each width.

The kits include: 2 struts, 4 mounting pieces, and an array of grills as per the diagram below

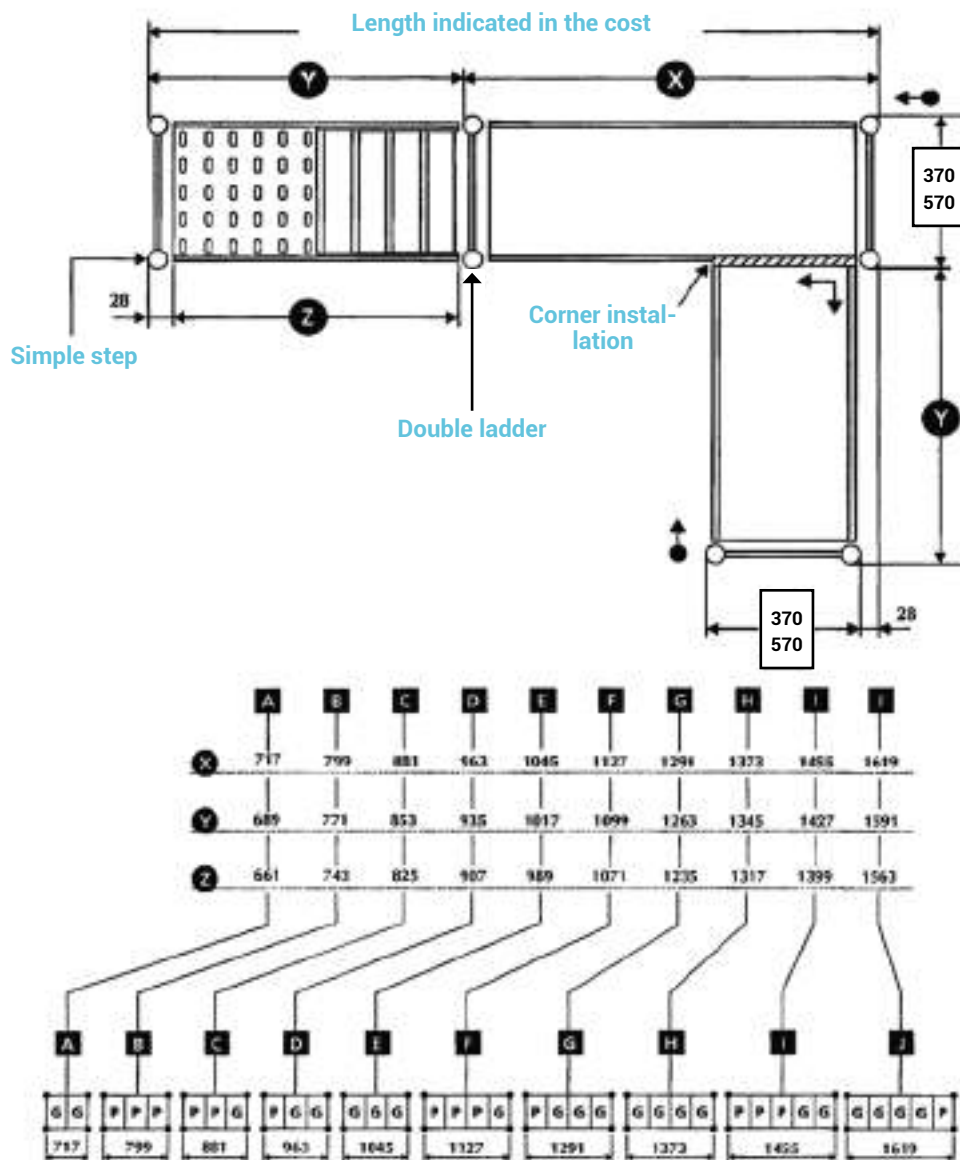

Depth	370	570
Large	325 x 325	525 x 325
Small	325 x 245	525 x 245

SHELVING

Freestanding aluminium

Polypropylene trays

- Made entirely out of food grade high density polypropylene.
- 2 struts, 4 mounting pieces, and an array of grills as per the diagram on page 125.
- Easy assembly.
- 370- or 570-mm-wide Grills.



370 mm Width

Length (mm)	Grill combination	Code
661	2G	• EAB00001
743	3P	• EAB00002
825	2P + 1G	• EAB00003
907	1P + 2G	• EAB00004
989	3G	• EAB00005
1071	3P + 1G	• EAB00006
1235	1P + 3G	• EAB00007
1317	4G	• EAB00008
1399	3P + 2G	• EAB00009
1563	1P + 4G	• EAB00010

570 mm Width

Length (mm)	Grill combination	Code
661	2G	• EAB00011
743	3P	• EAB00012
825	2P + 1G	• EAB00013
907	1P + 2G	• EAB00014
989	3G	• EAB00015
1071	3P + 1G	• EAB00016
1235	1P + 3G	• EAB00017
1317	4G	• EAB00018
1399	3P + 2G	• EAB00019
1563	1P + 4G	• EAB00020

Supports

- Made in two heights: 1700 or 2000 mm.
- These feature adjustable legs that can adapt to any kind of floor.
- Machined to allow shelves to be attached every 150 mm.

370 mm Width

Support height (mm)	Side support	Center support
1700	• EASL0001	• EASC0001
2000	• EASL0002	• EASC0002

570 mm Width

Support height (mm)	Side Support	Center support
1700	• EASL0003	• EASC0003
2000	• EASL0004	• EASC0004



• 24-hour shipping

Corner piece

- Accessory for mounting corner shelving.
- Price per unit.



For model	Code
370 mm Width	• EAPA0001
570 mm Width	• EAPA0002

Bench

- Specially designed to fulfill the hygienic and sanitary standards for refrigerated chambers, which prohibit direct contact between boxes and other products and the ground.



370 mm Width

Total dimensions (mm)	Code
717 x 370 x 250	• EABN0001
799 x 370 x 250	• EABN0002
881 x 370 x 250	• EABN0003
963 x 370 x 250	• EABN0004
1045 x 370 x 250	• EABN0005
1127 x 370 x 250	• EABN0006
1291 x 370 x 250	• EABN0007
1373 x 370 x 250	• EABN0008
1455 x 370 x 250	• EABN0009
1619 x 370 x 250	• EABN0010

570 mm Width

Total dimensions (mm)	Code
717 x 570 x 250	• EABN0011
799 x 570 x 250	• EABN0012
881 x 570 x 250	• EABN0013
963 x 570 x 250	• EABN0014
1045 x 570 x 250	• EABN0015
1127 x 570 x 250	• EABN0016
1291 x 570 x 250	• EABN0017
1373 x 570 x 250	• EABN0018
1455 x 570 x 250	• EABN0019
1619 x 570 x 250	• EABN0020

• 24-hour shipping

SHELVING

1700-mm-high linear sections



Aluminium with polypropylene trays •

370 mm Depth

570 mm Depth

Length (mm)	Shelves	3 Levels	4 Levels	5 Levels		Length (mm)	Shelves	3 Levels	4 Levels	5 Levels
717	A	EAL00001	EAL00055	EAL00109		2 Supports	717	A	EAL00163	EAL00217
799	B	EAL00002	EAL00056	EAL00110	799		B	EAL00164	EAL00218	EAL00272
881	C	EAL00003	EAL00057	EAL00111	881		C	EAL00165	EAL00219	EAL00273
963	D	EAL00004	EAL00058	EAL00112	963		D	EAL00166	EAL00220	EAL00274
1045	E	EAL00005	EAL00059	EAL00113	1045		E	EAL00167	EAL00221	EAL00275
1127	F	EAL00006	EAL00060	EAL00114	1127		F	EAL00168	EAL00222	EAL00276
1291	G	EAL00007	EAL00061	EAL00115	1291		G	EAL00169	EAL00223	EAL00277
1373	H	EAL00008	EAL00062	EAL00116	1373		H	EAL00170	EAL00224	EAL00278
1455	I	EAL00009	EAL00063	EAL00117	1455		I	EAL00171	EAL00225	EAL00279
1619	J	EAL00010	EAL00064	EAL00118	1619		J	EAL00172	EAL00226	EAL00280
1734	2C	EAL00011	EAL00065	EAL00119	3 Supports	1734	2C	EAL00173	EAL00227	EAL00281
1816	C + D	EAL00012	EAL00066	EAL00120		1816	C + D	EAL00174	EAL00228	EAL00282
1898	2D	EAL00013	EAL00067	EAL00121		1898	2D	EAL00175	EAL00229	EAL00283
1980	D + E	EAL00014	EAL00068	EAL00122		1980	D + E	EAL00176	EAL00230	EAL00284
2062	2E	EAL00015	EAL00069	EAL00123		2062	2E	EAL00177	EAL00231	EAL00285
2144	E + F	EAL00016	EAL00070	EAL00124		2144	E + F	EAL00178	EAL00232	EAL00286
2226	2 F	EAL00017	EAL00071	EAL00125		2226	2 F	EAL00179	EAL00233	EAL00287
2308	E + G	EAL00018	EAL00072	EAL00126		2308	E + G	EAL00180	EAL00234	EAL00288
2390	F + G	EAL00019	EAL00073	EAL00127		2390	F + G	EAL00181	EAL00235	EAL00289
2472	F + H	EAL00020	EAL00074	EAL00128		2472	F + H	EAL00182	EAL00236	EAL00290
2554	2G	EAL00021	EAL00075	EAL00129	2554	2G	EAL00183	EAL00237	EAL00291	
2636	G + H	EAL00022	EAL00076	EAL00130	2636	G + H	EAL00184	EAL00238	EAL00292	
2718	2H	EAL00023	EAL00077	EAL00131	2718	2H	EAL00185	EAL00239	EAL00293	
2800	H + I	EAL00024	EAL00078	EAL00132	2800	H + I	EAL00186	EAL00240	EAL00294	
2882	2I	EAL00025	EAL00079	EAL00133	2882	2I	EAL00187	EAL00241	EAL00295	
2964	H + J	EAL00026	EAL00080	EAL00134	2964	H + J	EAL00188	EAL00242	EAL00296	
3046	I + J	EAL00027	EAL00081	EAL00135	3046	I + J	EAL00189	EAL00243	EAL00297	
3210	2J	EAL00028	EAL00082	EAL00136	3210	2J	EAL00190	EAL00244	EAL00298	
3325	2E + G	EAL00029	EAL00083	EAL00137	4 Supports	3325	2E + G	EAL00191	EAL00245	EAL00299
3407	E + F + G	EAL00030	EAL00084	EAL00138		3407	E + F + G	EAL00192	EAL00246	EAL00300
3489	2F + G	EAL00031	EAL00085	EAL00139		3489	2F + G	EAL00193	EAL00247	EAL00301
3571	E + 2G	EAL00032	EAL00086	EAL00140		3571	E + 2G	EAL00194	EAL00248	EAL00302
3653	F + 2G	EAL00033	EAL00087	EAL00141		3653	F + 2G	EAL00195	EAL00249	EAL00303
3735	F + G + H	EAL00034	EAL00088	EAL00142		3735	F + G + H	EAL00196	EAL00250	EAL00304
3817	3G	EAL00035	EAL00089	EAL00143		3817	3G	EAL00197	EAL00251	EAL00305
3899	2G + H	EAL00036	EAL00090	EAL00144		3899	2G + H	EAL00198	EAL00252	EAL00306
3981	G + 2H	EAL00037	EAL00091	EAL00145		3981	G + 2H	EAL00199	EAL00253	EAL00307
4063	3H	EAL00038	EAL00092	EAL00146		4063	3H	EAL00200	EAL00254	EAL00308
4145	2H + I	EAL00039	EAL00093	EAL00147	4145	2H + I	EAL00201	EAL00255	EAL00309	
4227	H + 2I	EAL00040	EAL00094	EAL00148	4227	H + 2I	EAL00202	EAL00256	EAL00310	
4309	3I	EAL00041	EAL00095	EAL00149	4309	3I	EAL00203	EAL00257	EAL00311	
4391	H + I + J	EAL00042	EAL00096	EAL00150	4391	H + I + J	EAL00204	EAL00258	EAL00312	
4473	2I + J	EAL00043	EAL00097	EAL00151	4473	2I + J	EAL00205	EAL00259	EAL00313	
4555	H + 2J	EAL00044	EAL00098	EAL00152	4555	H + 2J	EAL00206	EAL00260	EAL00314	
4637	I + 2J	EAL00045	EAL00099	EAL00153	4637	I + 2J	EAL00207	EAL00261	EAL00315	
4801	3J	EAL00046	EAL00100	EAL00154	4801	3J	EAL00208	EAL00262	EAL00316	
4916	F + 3G	EAL00047	EAL00101	EAL00155	5 Supports	4916	F + 3G	EAL00209	EAL00263	EAL00317
4998	F + 2G + H	EAL00048	EAL00102	EAL00156		4998	F + 2G + H	EAL00210	EAL00264	EAL00318
5080	4G	EAL00049	EAL00103	EAL00157		5080	4G	EAL00211	EAL00265	EAL00319
5162	3G + H	EAL00050	EAL00104	EAL00158		5162	3G + H	EAL00212	EAL00266	EAL00320
5244	2G + 2H	EAL00051	EAL00105	EAL00159		5244	2G + 2H	EAL00213	EAL00267	EAL00321
5326	G + 3H	EAL00052	EAL00106	EAL00160		5326	G + 3H	EAL00214	EAL00268	EAL00322
5408	4H	EAL00053	EAL00107	EAL00161		5408	4H	EAL00215	EAL00269	EAL00323
5490	3H + I	EAL00054	EAL00108	EAL00162		5490	3H + I	EAL00216	EAL00270	EAL00324
5572	2H + 2I	EAL00649	EAL00651	EAL00653		5572	2H + 2I	EAL00655	EAL00657	EAL00659
5654	1H + 3I	EAL00650	EAL00652	EAL00654		5654	1H + 3I	EAL00656	EAL00658	EAL00660

• 24-hour shipping

1700-mm-angular sections

Aluminium with polypropylene trays .



370 mm Depth

570 mm Depth

Length (mm)	Shelves	3 Levels	4 Levels	5 Levels		Length (mm)	Shelves	3 Levels	4 Levels	5 Levels
689	A	EAA00001	EAA00055	EAA00109	2 Supports	689	A	EAA00163	EAA00217	EAA00271
771	B	EAA00002	EAA00056	EAA00110		771	B	EAA00164	EAA00218	EAA00272
853	C	EAA00003	EAA00057	EAA00111		853	C	EAA00165	EAA00219	EAA00273
935	D	EAA00004	EAA00058	EAA00112		935	D	EAA00166	EAA00220	EAA00274
1017	E	EAA00005	EAA00059	EAA00113		1017	E	EAA00167	EAA00221	EAA00275
1099	F	EAA00006	EAA00060	EAA00114		1099	F	EAA00168	EAA00222	EAA00276
1263	G	EAA00007	EAA00061	EAA00115		1263	G	EAA00169	EAA00223	EAA00277
1345	H	EAA00008	EAA00062	EAA00116		1345	H	EAA00170	EAA00224	EAA00278
1427	I	EAA00009	EAA00063	EAA00117		1427	I	EAA00171	EAA00225	EAA00279
1591	J	EAA00010	EAA00064	EAA00118		1591	J	EAA00172	EAA00226	EAA00280
1706	2C	EAA00011	EAA00065	EAA00119	3 Supports	1706	2C	EAA00173	EAA00227	EAA00281
1788	C + D	EAA00012	EAA00066	EAA00120		1788	C + D	EAA00174	EAA00228	EAA00282
1870	2D	EAA00013	EAA00067	EAA00121		1870	2D	EAA00175	EAA00229	EAA00283
1952	D + E	EAA00014	EAA00068	EAA00122		1952	D + E	EAA00176	EAA00230	EAA00284
2034	2E	EAA00015	EAA00069	EAA00123		2034	2E	EAA00177	EAA00231	EAA00285
2116	E + F	EAA00016	EAA00070	EAA00124		2116	E + F	EAA00178	EAA00232	EAA00286
2198	2 F	EAA00017	EAA00071	EAA00125		2198	2 F	EAA00179	EAA00233	EAA00287
2280	E + G	EAA00018	EAA00072	EAA00126		2280	E + G	EAA00180	EAA00234	EAA00288
2362	F + G	EAA00019	EAA00073	EAA00127		2362	F + G	EAA00181	EAA00235	EAA00289
2444	F + H	EAA00020	EAA00074	EAA00128		2444	F + H	EAA00182	EAA00236	EAA00290
2526	2G	EAA00021	EAA00075	EAA00129	2526	2G	EAA00183	EAA00237	EAA00291	
2608	G + H	EAA00022	EAA00076	EAA00130	2608	G + H	EAA00184	EAA00238	EAA00292	
2690	2H	EAA00023	EAA00077	EAA00131	2690	2H	EAA00185	EAA00239	EAA00293	
2772	H + I	EAA00024	EAA00078	EAA00132	2772	H + I	EAA00186	EAA00240	EAA00294	
2854	2I	EAA00025	EAA00079	EAA00133	2854	2I	EAA00187	EAA00241	EAA00295	
2936	H + J	EAA00026	EAA00080	EAA00134	2936	H + J	EAA00188	EAA00242	EAA00296	
3018	I + J	EAA00027	EAA00081	EAA00135	3018	I + J	EAA00189	EAA00243	EAA00297	
3182	2J	EAA00028	EAA00082	EAA00136	3182	2J	EAA00190	EAA00244	EAA00298	
3297	2E + G	EAA00029	EAA00083	EAA00137	4 Supports	3297	2E + G	EAA00191	EAA00245	EAA00299
3379	E + F + G	EAA00030	EAA00084	EAA00138		3379	E + F + G	EAA00192	EAA00246	EAA00300
3461	2F + G	EAA00031	EAA00085	EAA00139		3461	2F + G	EAA00193	EAA00247	EAA00301
3543	E + 2G	EAA00032	EAA00086	EAA00140		3543	E + 2G	EAA00194	EAA00248	EAA00302
3625	F + 2G	EAA00033	EAA00087	EAA00141		3625	F + 2G	EAA00195	EAA00249	EAA00303
3707	F + G + H	EAA00034	EAA00088	EAA00142		3707	F + G + H	EAA00196	EAA00250	EAA00304
3789	3G	EAA00035	EAA00089	EAA00143		3789	3G	EAA00197	EAA00251	EAA00305
3871	2G + H	EAA00036	EAA00090	EAA00144		3871	2G + H	EAA00198	EAA00252	EAA00306
3953	G + 2H	EAA00037	EAA00091	EAA00145		3953	G + 2H	EAA00199	EAA00253	EAA00307
4035	3H	EAA00038	EAA00092	EAA00146		4035	3H	EAA00200	EAA00254	EAA00308
4117	2H + I	EAA00039	EAA00093	EAA00147	4117	2H + I	EAA00201	EAA00255	EAA00309	
4199	H + 2I	EAA00040	EAA00094	EAA00148	4199	H + 2I	EAA00202	EAA00256	EAA00310	
4281	3I	EAA00041	EAA00095	EAA00149	4281	3I	EAA00203	EAA00257	EAA00311	
4363	H + I + J	EAA00042	EAA00096	EAA00150	4363	H + I + J	EAA00204	EAA00258	EAA00312	
4445	2I + J	EAA00043	EAA00097	EAA00151	4445	2I + J	EAA00205	EAA00259	EAA00313	
4527	H + 2J	EAA00044	EAA00098	EAA00152	4527	H + 2J	EAA00206	EAA00260	EAA00314	
4609	I + 2J	EAA00045	EAA00099	EAA00153	4609	I + 2J	EAA00207	EAA00261	EAA00315	
4773	3J	EAA00046	EAA00100	EAA00154	4773	3J	EAA00208	EAA00262	EAA00316	
4888	F + 3G	EAA00047	EAA00101	EAA00155	5 Supports	4888	F + 3G	EAA00209	EAA00263	EAA00317
4970	F + 2G + H	EAA00048	EAA00102	EAA00156		4970	F + 2G + H	EAA00210	EAA00264	EAA00318
5052	4G	EAA00049	EAA00103	EAA00157		5052	4G	EAA00211	EAA00265	EAA00319
5134	3G + H	EAA00050	EAA00104	EAA00158		5134	3G + H	EAA00212	EAA00266	EAA00320
5216	2G + 2H	EAA00051	EAA00105	EAA00159		5216	2G + 2H	EAA00213	EAA00267	EAA00321
5298	G + 3H	EAA00052	EAA00106	EAA00160		5298	G + 3H	EAA00214	EAA00268	EAA00322
5380	4H	EAA00053	EAA00107	EAA00161		5380	4H	EAA00215	EAA00269	EAA00323
5462	3H + I	EAA00054	EAA00108	EAA00162		5462	3H + I	EAA00216	EAA00270	EAA00324
5544	2H + 2I	EAA00649	EAA00651	EAA00653		5544	2H + 2I	EAA00655	EAA00657	EAA00659
5626	1H + 3I	EAA00650	EAA00652	EAA00654		5626	1H + 3I	EAA00656	EAA00658	EAA00660

• 24-hour shipping

SHELVING

2000-mm-high linear sections



Aluminium with polypropylene trays .

370 mm Depth

Length (mm)	Shelves	3 Levels	4 Levels	5 Levels
717	A	EAL00325	EAL00379	EAL00433
799	B	EAL00326	EAL00380	EAL00434
881	C	EAL00327	EAL00381	EAL00435
963	D	EAL00328	EAL00382	EAL00436
1045	E	EAL00329	EAL00383	EAL00437
1127	F	EAL00330	EAL00384	EAL00438
1291	G	EAL00331	EAL00385	EAL00439
1373	H	EAL00332	EAL00386	EAL00440
1455	I	EAL00333	EAL00387	EAL00441
1619	J	EAL00334	EAL00388	EAL00442
1734	2C	EAL00335	EAL00389	EAL00443
1816	C + D	EAL00336	EAL00390	EAL00444
1898	2D	EAL00337	EAL00391	EAL00445
1980	D + E	EAL00338	EAL00392	EAL00446
2062	2E	EAL00339	EAL00393	EAL00447
2144	E + F	EAL00340	EAL00394	EAL00448
2226	2 F	EAL00341	EAL00395	EAL00449
2308	E + G	EAL00342	EAL00396	EAL00450
2390	F + G	EAL00343	EAL00397	EAL00451
2472	F+ H	EAL00344	EAL00398	EAL00452
2554	2G	EAL00345	EAL00399	EAL00453
2636	G + H	EAL00346	EAL00400	EAL00454
2718	2H	EAL00347	EAL00401	EAL00455
2800	H + I	EAL00348	EAL00402	EAL00456
2882	2I	EAL00349	EAL00403	EAL00457
2964	H + J	EAL00350	EAL00404	EAL00458
3046	I + J	EAL00351	EAL00405	EAL00459
3210	2J	EAL00352	EAL00406	EAL00460
3325	2E + G	EAL00353	EAL00407	EAL00461
3407	E + F + G	EAL00354	EAL00408	EAL00462
3489	2F + G	EAL00355	EAL00409	EAL00463
3571	E + 2G	EAL00356	EAL00410	EAL00464
3653	F + 2G	EAL00357	EAL00411	EAL00465
3735	F + G + H	EAL00358	EAL00412	EAL00466
3817	3G	EAL00359	EAL00413	EAL00467
3899	2G + H	EAL00360	EAL00414	EAL00468
3981	G + 2H	EAL00361	EAL00415	EAL00469
4063	3H	EAL00362	EAL00416	EAL00470
4145	2H + I	EAL00363	EAL00417	EAL00471
4227	H + 2I	EAL00364	EAL00418	EAL00472
4309	3I	EAL00365	EAL00419	EAL00473
4391	H + I + J	EAL00366	EAL00420	EAL00474
4473	2I + J	EAL00367	EAL00421	EAL00475
4555	H + 2J	EAL00368	EAL00422	EAL00476
4637	I + 2J	EAL00369	EAL00423	EAL00477
4801	3J	EAL00370	EAL00424	EAL00478
4916	F + 3G	EAL00371	EAL00425	EAL00479
4998	F + 2G + H	EAL00372	EAL00426	EAL00480
5080	4G	EAL00373	EAL00427	EAL00481
5162	3G + H	EAL00374	EAL00428	EAL00482
5244	2G + 2H	EAL00375	EAL00429	EAL00483
5326	G + 3H	EAL00376	EAL00430	EAL00484
5408	4H	EAL00377	EAL00431	EAL00485
5490	3H + I	EAL00378	EAL00432	EAL00486
5572	2H + 2I	EAL00661	EAL00663	EAL00665
5654	1H + 3I	EAL00662	EAL00664	EAL00666

570 mm Depth

Length (mm)	Shelves	3 Levels	4 Levels	5 Levels
717	A	EAL00487	EAL00541	EAL00595
799	B	EAL00488	EAL00542	EAL00596
881	C	EAL00489	EAL00543	EAL00597
963	D	EAL00490	EAL00544	EAL00598
1045	E	EAL00491	EAL00545	EAL00599
1127	F	EAL00492	EAL00546	EAL00600
1291	G	EAL00493	EAL00547	EAL00601
1373	H	EAL00494	EAL00548	EAL00602
1455	I	EAL00495	EAL00549	EAL00603
1619	J	EAL00496	EAL00550	EAL00604
1734	2C	EAL00497	EAL00551	EAL00605
1816	C + D	EAL00498	EAL00552	EAL00606
1898	2D	EAL00499	EAL00553	EAL00607
1980	D + E	EAL00500	EAL00554	EAL00608
2062	2E	EAL00501	EAL00555	EAL00609
2144	E + F	EAL00502	EAL00556	EAL00610
2226	2 F	EAL00503	EAL00557	EAL00611
2308	E + G	EAL00504	EAL00558	EAL00612
2390	F + G	EAL00505	EAL00559	EAL00613
2472	F+ H	EAL00506	EAL00560	EAL00614
2554	2G	EAL00507	EAL00561	EAL00615
2636	G + H	EAL00508	EAL00562	EAL00616
2718	2H	EAL00509	EAL00563	EAL00617
2800	H + I	EAL00510	EAL00564	EAL00618
2882	2I	EAL00511	EAL00565	EAL00619
2964	H + J	EAL00512	EAL00566	EAL00620
3046	I + J	EAL00513	EAL00567	EAL00621
3210	2J	EAL00514	EAL00568	EAL00622
3325	2E + G	EAL00515	EAL00569	EAL00623
3407	E + F + G	EAL00516	EAL00570	EAL00624
3489	2F + G	EAL00517	EAL00571	EAL00625
3571	E + 2G	EAL00518	EAL00572	EAL00626
3653	F + 2G	EAL00519	EAL00573	EAL00627
3735	F + G + H	EAL00520	EAL00574	EAL00628
3817	3G	EAL00521	EAL00575	EAL00629
3899	2G + H	EAL00522	EAL00576	EAL00630
3981	G + 2H	EAL00523	EAL00577	EAL00631
4063	3H	EAL00524	EAL00578	EAL00632
4145	2H + I	EAL00525	EAL00579	EAL00633
4227	H + 2I	EAL00526	EAL00580	EAL00634
4309	3I	EAL00527	EAL00581	EAL00635
4391	H + I + J	EAL00528	EAL00582	EAL00636
4473	2I + J	EAL00529	EAL00583	EAL00637
4555	H + 2J	EAL00530	EAL00584	EAL00638
4637	I + 2J	EAL00531	EAL00585	EAL00639
4801	3J	EAL00532	EAL00586	EAL00640
4916	F + 3G	EAL00533	EAL00587	EAL00641
4998	F + 2G + H	EAL00534	EAL00588	EAL00642
5080	4G	EAL00535	EAL00589	EAL00643
5162	3G + H	EAL00536	EAL00590	EAL00644
5244	2G + 2H	EAL00537	EAL00591	EAL00645
5326	G + 3H	EAL00538	EAL00592	EAL00646
5408	4H	EAL00539	EAL00593	EAL00647
5490	3H + I	EAL00540	EAL00594	EAL00648
5572	2H + 2I	EAL00667	EAL00669	EAL00671
5654	1H + 3I	EAL00668	EAL00670	EAL00672

• 24-hour shipping

2000-mm-high angular sections

Aluminium with polypropylene trays



370 mm Depth

570 mm Depth

Length (mm)	Shelves	3 Levels	4 Levels	5 Levels		Length (mm)	Shelves	3 Levels	4 Levels	5 Levels
689	A	EAA00325	EAA00379	EAA00433	2 Supports	689	A	EAA00487	EAA00541	EAA00595
771	B	EAA00326	EAA00380	EAA00434		771	B	EAA00488	EAA00542	EAA00596
853	C	EAA00327	EAA00381	EAA00435		853	C	EAA00489	EAA00543	EAA00597
935	D	EAA00328	EAA00382	EAA00436		935	D	EAA00490	EAA00544	EAA00598
1017	E	EAA00329	EAA00383	EAA00437		1017	E	EAA00491	EAA00545	EAA00599
1099	F	EAA00330	EAA00384	EAA00438		1099	F	EAA00492	EAA00546	EAA00600
1263	G	EAA00331	EAA00385	EAA00439		1263	G	EAA00493	EAA00547	EAA00601
1345	H	EAA00332	EAA00386	EAA00440		1345	H	EAA00494	EAA00548	EAA00602
1427	I	EAA00333	EAA00387	EAA00441		1427	I	EAA00495	EAA00549	EAA00603
1591	J	EAA00334	EAA00388	EAA00442		1591	J	EAA00496	EAA00550	EAA00604
1706	2C	EAA00335	EAA00389	EAA00443	3 Supports	1706	2C	EAA00497	EAA00551	EAA00605
1788	C + D	EAA00336	EAA00390	EAA00444		1788	C + D	EAA00498	EAA00552	EAA00606
1870	2D	EAA00337	EAA00391	EAA00445		1870	2D	EAA00499	EAA00553	EAA00607
1952	D + E	EAA00338	EAA00392	EAA00446		1952	D + E	EAA00500	EAA00554	EAA00608
2034	2E	EAA00339	EAA00393	EAA00447		2034	2E	EAA00501	EAA00555	EAA00609
2116	E + F	EAA00340	EAA00394	EAA00448		2116	E + F	EAA00502	EAA00556	EAA00610
2198	2F	EAA00341	EAA00395	EAA00449		2198	2F	EAA00503	EAA00557	EAA00611
2280	E + G	EAA00342	EAA00396	EAA00450		2280	E + G	EAA00504	EAA00558	EAA00612
2362	F + G	EAA00343	EAA00397	EAA00451		2362	F + G	EAA00505	EAA00559	EAA00613
2444	F + H	EAA00344	EAA00398	EAA00452		2444	F + H	EAA00506	EAA00560	EAA00614
2526	2G	EAA00345	EAA00399	EAA00453	2526	2G	EAA00507	EAA00561	EAA00615	
2608	G + H	EAA00346	EAA00400	EAA00454	2608	G + H	EAA00508	EAA00562	EAA00616	
2690	2H	EAA00347	EAA00401	EAA00455	2690	2H	EAA00509	EAA00563	EAA00617	
2772	H + I	EAA00348	EAA00402	EAA00456	2772	H + I	EAA00510	EAA00564	EAA00618	
2854	2I	EAA00349	EAA00403	EAA00457	2854	2I	EAA00511	EAA00565	EAA00619	
2936	H + J	EAA00350	EAA00404	EAA00458	2936	H + J	EAA00512	EAA00566	EAA00620	
3018	I + J	EAA00351	EAA00405	EAA00459	3018	I + J	EAA00513	EAA00567	EAA00621	
3182	2J	EAA00352	EAA00406	EAA00460	3182	2J	EAA00514	EAA00568	EAA00622	
3297	2E + G	EAA00353	EAA00407	EAA00461	4 Supports	3297	2E + G	EAA00515	EAA00569	EAA00623
3379	E + F + G	EAA00354	EAA00408	EAA00462		3379	E + F + G	EAA00516	EAA00570	EAA00624
3461	2F + G	EAA00355	EAA00409	EAA00463		3461	2F + G	EAA00517	EAA00571	EAA00625
3543	E + 2G	EAA00356	EAA00410	EAA00464		3543	E + 2G	EAA00518	EAA00572	EAA00626
3625	F + 2G	EAA00357	EAA00411	EAA00465		3625	F + 2G	EAA00519	EAA00573	EAA00627
3707	F + G + H	EAA00358	EAA00412	EAA00466		3707	F + G + H	EAA00520	EAA00574	EAA00628
3789	3G	EAA00359	EAA00413	EAA00467		3789	3G	EAA00521	EAA00575	EAA00629
3871	2G + H	EAA00360	EAA00414	EAA00468		3871	2G + H	EAA00522	EAA00576	EAA00630
3953	G + 2H	EAA00361	EAA00415	EAA00469		3953	G + 2H	EAA00523	EAA00577	EAA00631
4035	3H	EAA00362	EAA00416	EAA00470		4035	3H	EAA00524	EAA00578	EAA00632
4117	2H + I	EAA00363	EAA00417	EAA00471	4117	2H + I	EAA00525	EAA00579	EAA00633	
4199	H + 2I	EAA00364	EAA00418	EAA00472	4199	H + 2I	EAA00526	EAA00580	EAA00634	
4281	3I	EAA00365	EAA00419	EAA00473	4281	3I	EAA00527	EAA00581	EAA00635	
4363	H + I + J	EAA00366	EAA00420	EAA00474	4363	H + I + J	EAA00528	EAA00582	EAA00636	
4445	2I + J	EAA00367	EAA00421	EAA00475	4445	2I + J	EAA00529	EAA00583	EAA00637	
4527	H + 2J	EAA00368	EAA00422	EAA00476	4527	H + 2J	EAA00530	EAA00584	EAA00638	
4609	I + 2J	EAA00369	EAA00423	EAA00477	4609	I + 2J	EAA00531	EAA00585	EAA00639	
4773	3J	EAA00370	EAA00424	EAA00478	4773	3J	EAA00532	EAA00586	EAA00640	
4888	F + 3G	EAA00371	EAA00425	EAA00479	5 Supports	4888	F + 3G	EAA00533	EAA00587	EAA00641
4970	F + 2G + H	EAA00372	EAA00426	EAA00480		4970	F + 2G + H	EAA00534	EAA00588	EAA00642
5052	4G	EAA00373	EAA00427	EAA00481		5052	4G	EAA00535	EAA00589	EAA00643
5134	3G + H	EAA00374	EAA00428	EAA00482		5134	3G + H	EAA00536	EAA00590	EAA00644
5216	2G + 2H	EAA00375	EAA00429	EAA00483		5216	2G + 2H	EAA00537	EAA00591	EAA00645
5298	G + 3H	EAA00376	EAA00430	EAA00484		5298	G + 3H	EAA00538	EAA00592	EAA00646
5380	4H	EAA00377	EAA00431	EAA00485		5380	4H	EAA00539	EAA00593	EAA00647
5462	3H + I	EAA00378	EAA00432	EAA00486		5462	3H + I	EAA00540	EAA00594	EAA00648
5544	2H + 2I	EAA00661	EAA00663	EAA00665		5544	2H + 2I	EAA00667	EAA00669	EAA00671
5626	1H + 3I	EAA00662	EAA00664	EAA00666		5626	1H + 3I	EAA00668	EAA00670	EAA00672

• 24-hour shipping

FOOD DISTRIBUTION AND DISPLAY

Transport trolleys

Pages 135 - 143

Temperature maintenance and bain-marie trolleys

Pages 144 - 151

Regeneration ovens

Pages 152 - 157

Gastronorm containers

Pages 158 - 163

Drop-In

Pages 164 - 179

Self-Service

Pages 180 - 201



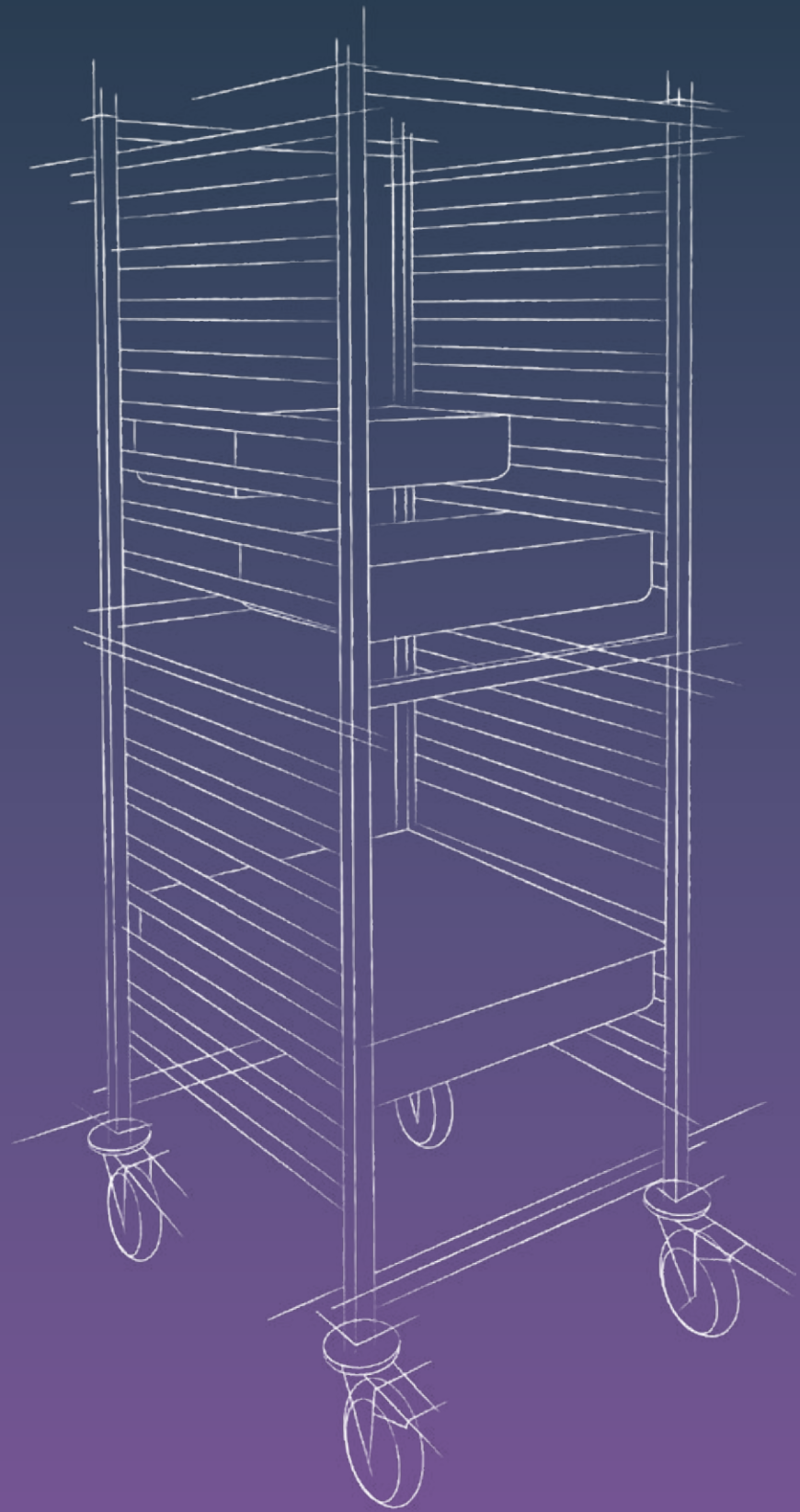

TRANSPORT TROLLEYS

Serving trolleys **P. 136**

Transport trolleys **P. 138**

TRANSPORT TROLLEYS

Serving

Serving trolleys

- The **sturdiness of the trolleys allows them to transport heavy loads.**
- Made of AISI grade 304 stainless steel (18/10).
- Inlay design and raised outer edges make shelves very sturdy.
- Maximum load distributed across each shelf is 75 kg, with a total maximum load of 200 kg.
- Four Ø125 mm castors with bumpers (2 with brakes).

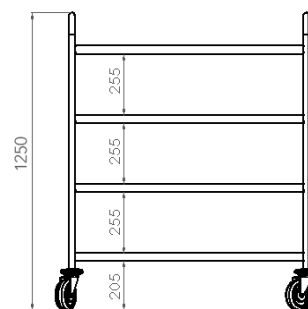
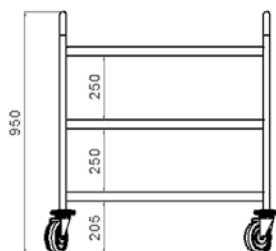
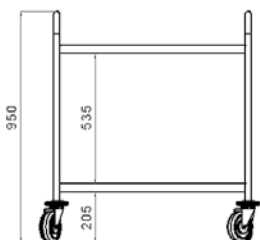

2 shelves

Total dimensions(mm)	Shelf dimensions(mm)	Assembled Trolley	Disassembled Trolley
895 x 595 x 950	800 x 500	• F0260401	• FD260401
995 x 595 x 950	900 x 500	• F0260402	• FD260402
1095 x 695 x 950	1000 x 600	• F0260403	• FD260403

3 shelves

Total dimensions(mm)	Shelf dimensions(mm)	Assembled Trolley	Disassembled Trolley
895 x 595 x 950	800 x 500	• F0260404	• FD260404
995 x 595 x 950	900 x 500	• F0260405	• FD260405
1095 x 695 x 950	1000 x 600	• F0260406	• FD260406

4 shelves

Total dimensions(mm)	Shelf dimensions(mm)	Assembled Trolley
995 x 595 x 1250	900 x 500	• F0260407
1095 x 695 x 1250	1000 x 600	• F0260408

• 24-hour shipping

Accessories for service trolleys

- Easy to install on the service trolley without the use of tools.
- Stainless steel utensil basket holder.
- 200 mm Gastronorm 1/3 container holder.
- 200 mm Gastronorm 1/3 pan not included.



Waste bag holder

For Trolley	Total dimensions (mm)	Code
Width 595	527 x 285 x 50	• F0260209
Width 695	627 x 285 x 50	• F0260201



Utensil basket holder

For Trolley	Total dimensions (mm)	Code
Width 595	525 x 149 x 125	• F0260210
Width 695	625 x 149 x 125	• F0260202



Gastronorm container holder

Model	Code
Support	• F0260207
Basin	• RGN13200



Reinforced trolley for heavy loads

- **Designed to transport heavy loads.**
- Made entirely of AISI grade 304 stainless steel (18/10).
- Maximum load of 300 kg.
- Ø30mm tubular handles.
- Four Ø150mm castors (2 with brakes).
- Easy assembly in 3 minutes.

Total dimensions(mm)	Code
1040 x 640 x 1050	• F0260002



• 24-hour shipping

TRANSPORT TROLLEYS

Reinforced GN trolley

- Made entirely of AISI grade 304 stainless steel (18/10).
- Sets of runners: 18
- Distance between runners: 75 mm.
- Four Ø125 mm castors with bumpers (2 with brakes).
- Gastronorm containers not included.
- Quick and easy assembly in just 5 minutes.



Gastronorm containers
Page 160

Model	Total dimensions(mm)	Code
GN 1/1	460 x 630 x 1700	• F0260601
GN 2/1	660 x 750 x 1700	• F0260901



Protective cover for reinforced GN trolley

- 200-micron-thick transparent PVC cover.
- Zip closure.
- Reinforced seams.
- Not machine washable; hand wash only.

Model	Code
GN 1/1	• F0260602
GN 2/1	• F0260902



Short reinforced GN trolley

- Made entirely of AISI grade 304 stainless steel (18/10).
- Sets of runners: 7.
- Distance between runners: 75 mm.
- Four Ø125 mm castors with bumpers (2 with brakes).
- Gastronorm containers not included.
- Quick and easy assembly in just 5 minutes.



Gastronorm containers
Page 160

Model	Total dimensions (mm)	Code
GN 1/1	460 x 630 x 900	• F0260611
GN 2/1	660 x 750 x 900	• F0260911



• 24-hour shipping

Reinforced GN 2/1 racking trolley

- **Designed to be separated into 2 pieces for easy storage.**
- Made entirely of AISI grade 304 stainless steel (18/10).
- Sets of runners: 18.
- Distance between runners: 75 mm.
- Four Ø125 mm castors with bumpers (2 with brakes).
- Containers not included.
- No assembly required.



Gastronorm containers
Page 160



Reinforced bakery trolley

- Made entirely of AISI grade 304 stainless steel (18/10).
- Sets of runners: 16.
- Distance between runners: 85 mm.
- Four Ø125 mm castors with bumpers (2 with brakes).
- Quick and easy assembly in just 5 minutes.

Total dimensions(mm)	Code
670 x 750 x 1720	• F0261301

Washing trolley

- **Designed for washing vegetables or transporting different foods.**
- Made entirely of AISI grade 304 stainless steel (18/10).
- Perforated false bottom.
- Drain with tap.
- Four Ø105mm castors.
- 600 x 500 x 300 mm Basin.
- No assembly required.

Total dimensions(mm)	Code
600 x 500 x 600	• F0260701



• 24-hour shipping

TRANSPORT TROLLEYS

Plate rack trolley

- **Designed for plating large numbers of dishes before service.**
- Made entirely of AISI grade 304 stainless steel (18/10).
- Capacity for 80 plates with diameters of 200 to 320 mm or 120 plates with diameters of less than 200 mm.
- Comes with a bag of 160 rubber bars for increased safety during movement.
- 540 x 273 mm stainless steel grilles with Ø7 mm bars.
- Ø25 mm stainless steel handle.
- Four Ø125 mm castors with bumpers (2 with brakes).
- Distance between runners: 70 mm.
- Number of levels: 2 x 20.
- No assembly required.

Total dimensions (mm)	Code
645 x 665 x 1740	• F0260301

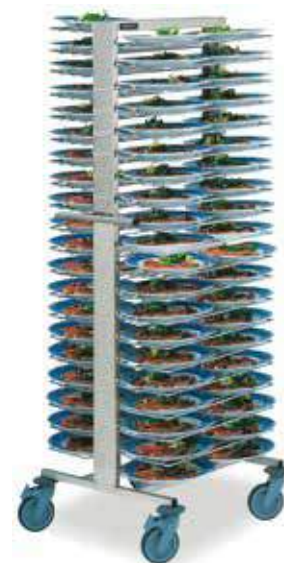

Protective cover for plate rack trolley

- **200-micron-thick transparent PVC cover.**
- Zip closure.
- Reinforced seams.

Total dimensions (mm)	Code
660 x 750 x 1700	• F0260902



Countertop plate rack

- **Its small size makes this rack excellent for plating in medium-sized kitchens.**
- Structure made entirely of AISI 304 stainless steel (18/10) with 25 mm square tube.
- Capacity for 20 plates between 200 to 320 mm in diameter or 30 plates less than 200mm in diameter.
- Stainless steel grilles with Ø7 mm bars.
- Number of levels: 10.
- Distance between runners: 76 mm.
- No assembly required.

Total dimensions (mm)	Code
575 x 320 x 855	• F0260302



• 24-hour shipping

Stock and plate transportation trolley

- Made of AISI 304 18/10 stainless steel.
- Very sturdy, fully-welded structure.
- Shelves lean inwards to prevent plates from falling.
- Four Ø125 mm castors with bumpers (2 with brakes).
- The double model can stack plates measuring up to Ø32 cm on one side and Ø26 cm on the other.
- Bar separator not included.
- No assembly required.



Single

Total dimensions (mm)	Plate capacity	Ø maximum	Code
1165 x 570 x 850	150	32 cm	• F0261501

Double

Total dimensions (mm)	Plate capacity	Ø maximum	Code
1165 x 785 x 850	300	32/36 cm	• F0261502

Bar separator

Code
• F0260208

* Price per unit



Solid food trolley

- Made entirely of AISI grade 304 stainless steel (18/10).
- Four Ø50 mm castors.
- Removable swinging lid.
- Airtight container.
- Floor inlaid with sanitary radius to facilitate cleaning.
- Capacity of 135 L.
- No assembly required.

Total dimensions (mm)	Code
395 x 610 x 725	• F0260503



• 24-hour shipping

TRANSPORT TROLLEYS

Tray trolley

- Made entirely of AISI grade 304 stainless steel (18/10).
- Fully welded sturdy structure.
- Maximum load of 5 kg per level.
- Four Ø125 mm castors with bumpers (2 with brakes).
- Distance between runners: 120 mm.
- For standard-dimension 450 x 350 mm, 480 x 370 mm, GN 1/1, and 350 x 270 mm (fast food) trays, or other trays (maximum dimensions of 530 x 370 mm).
- Closed models include stainless steel side panels.
- No assembly required.



Single or double opening

Total dimensions (mm)	Runners	Code
565 x 650 x 1720	12	• F0261101
970 x 650 x 1720	12 + 12	• F0261201

Single or double closed sides

Total dimensions (mm)	Runners	Code
565 x 650 x 1720	12	• F0261102
970 x 650 x 1720	12 + 12	• F0261202

Fast food waste receptacle

- **Designed for use in fast-food restaurants, self-service areas, buffets, etc.**
- Made of AISI grade 304 stainless steel (18/10).
- Sloped ramp facilitates movement of waste into the bin.
- Capacity for waste bins up to Ø500 mm and 690 mm in height.
- No assembly required.

Total dimensions(mm)	Code
668 x 585 x 1300	• F0260512

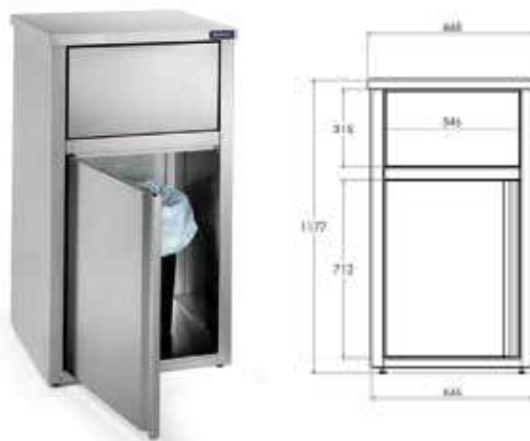

• 24-hour shipping

Trolleys for dish racks

- For storing and transporting 500 x 500 mm Dish racks.
- Made entirely of AISI grade 304 stainless steel (18/10).
- Maximum load of 80 kg.
- Four Ø125 mm castors with bumpers (2 with brakes).
- Ø25 mm tube handles on model F0260101.
- Features non-marking rubber protectors on each corner (model F0260001).
- No assembly required.

With handle

Total dimensions (mm)	Code
731 x 634 x 1050	• F0260101

No handle

Total dimensions (mm)	Code
520 x 520 x 250	• F0260001



Dish rack trolley

- Made entirely of AISI grade 304 stainless steel (18/10).
- 25 mm square tube structure.
- Sets of runners: 7.
- Distance between runners: 198 mm.
- Four Ø125 mm castors with bumpers (2 with brakes).
- Dish racks not included.
- Quick and easy assembly in just 5 minutes.

Total dimensions (mm)	Code
625 x 637 x 1720	• F0261701



Waste container with castors and lid

- Made entirely of AISI grade 304 stainless steel (18/10).
- Floor inlaid with sanitary radius to facilitate cleaning.
- No assembly required.

Pedal-operated lid

Total dimensions (mm)	Capacity (liters)	Castors	Code
380 Ø x 605	50	2 dimension Ø 50 mm	• F0260502
450 Ø x 685	95	2 dimension Ø 50 mm	• F0260505



Separate lid

Total dimensions (mm)	Capacity (liters)	Castors	Code
380 Ø x 605	50	3 dimension Ø 50 mm	• F0260501
450 Ø x 685	95	3 dimension Ø 50 mm	• F0260504



• 24-hour shipping

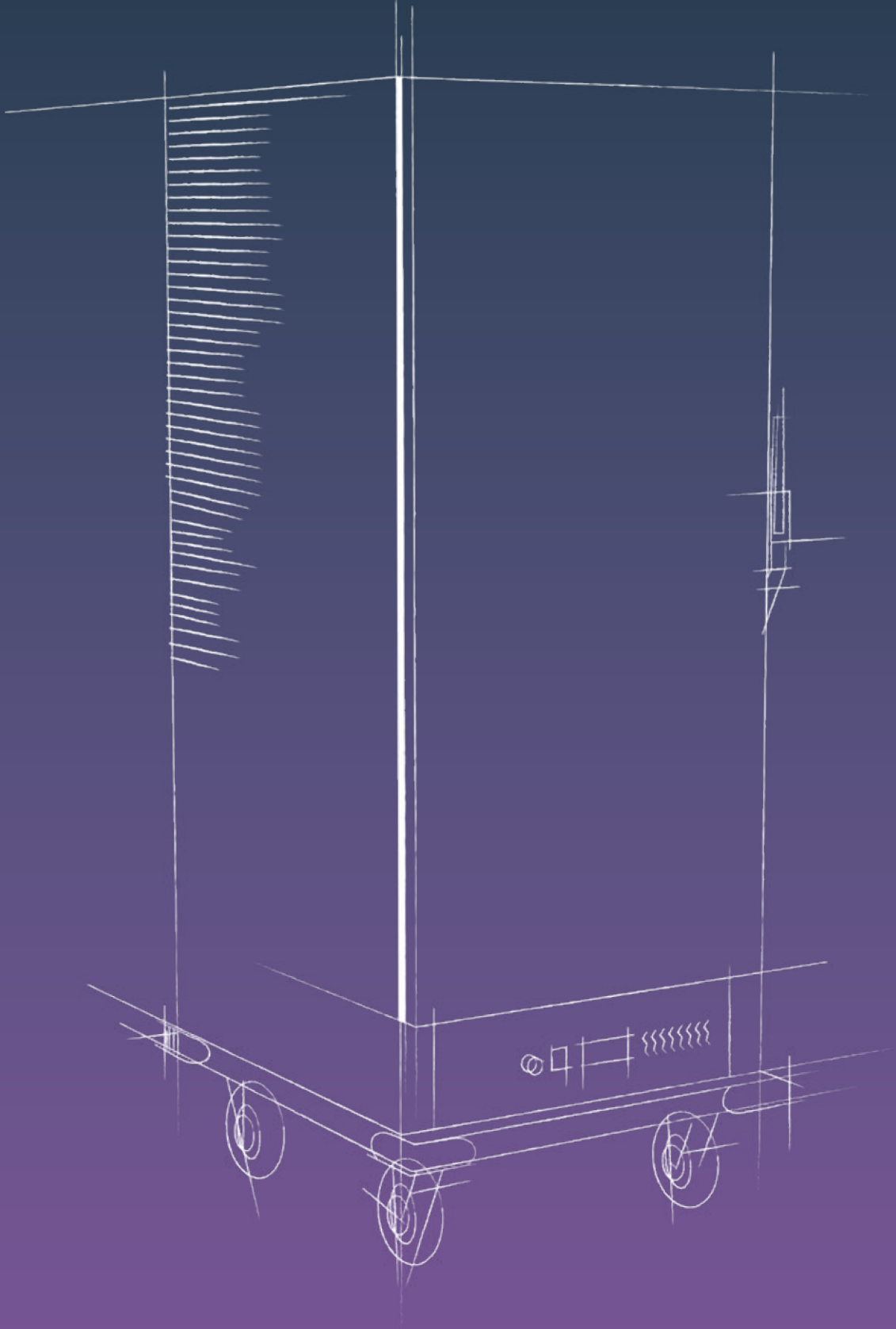

TEMPERATURE MAINTENANCE AND BAINE MARIE TROLLEYS

ACR Heated Holding Trolley	P. 146
ACG Heated Holding Trolley	P. 148
ACGF Cold Holding Trolley	P. 149
Cold Trolleys	P. 150
Bain-marie Trolleys	P. 151

TEMPERATURE MAINTENANCE AND BAIN-MARIE TROLLEYS

ACR Heated Holding Trolley

Specially designed for banquets and catering

NEW

Circulates hot air evenly
 Its unique positioning system for basins and grill racks prevents contact with walls, allowing the hot air inside to better circulate.

Saves energy.
 Thanks to their mineral wool insulation system, trolleys reach the desired temperature faster and maintain it for longer.

Opening the door 270°
 Upper and lower hinges in stainless steel with a swivel pivot point for full door opening



Central grill rack included with model ACR-2 to optimize all of the usable space.



← **Locking handles** with key included.

→ **Improved ergonomic design**
 Rear vertical handles and rubber protectors on each corner make this Trolley easy to move without leaving marks.

→ **High-resistance castors** measuring Ø150 mm, 2 with brakes. For any surface.

↑ **Control panel**
 Lighted power switch, thermostat for regulating temperature between 0 °C and 90 °C.



Extreme cleanliness
 The heat block and set of monoblock runners (no welding) are easily removable for easy cleaning of the inside of the trolley.

Moisture inside chamber
 Humidifier container included. For serving food at the optimal juiciness and temperature.

General specifications

- **Designed to facilitate transporting and serving hot foods.**
- Made of AISI grade 304 stainless steel (18/10).
- Capacity for 5, 10, 20, or 40 GN 2/1 containers on one or two sets of single-block runners (single piece), depending on the model.
- Double layer wall with mineral wool insulation to reduce heat loss and energy usage.
- Fully-removable heat block, ventilated heating element and tub for humidification system included.
- Control panel with lighted switch, heating element indicator light, and digital thermostat.
- Silicone gasket covering full door frame to maintain interior temperature.
- Model ACR-2 includes central grill racks to optimize interior space.
- Four Ø150 mm high-resistance castors (2 with brakes).
- Rear vertical handles for excellent mobility.
- Features non-marking rubber bumpers on each corner of the trolley's base.
- Locking handle with key included.
- Spiral single-phase connecting cord with ground connection.
- Grill racks and Gastronorm containers not included.

 **Gastronorm containers**
Page 160

 **GN grill racks**
Page 163



ACR-Mini

ACR-B

ACR-1

ACR-2

90 °C

Model	Total dimensions (mm)	Capacity	Distance between runners	Power (kW)	Power supply (V/N/Hz)	Code
ACR-Mini	700 x 805 x 845	5 GN 2/1 or 10 GN 1/1	60 mm	3000 W	230/1/50-60	• F0400007
ACR-B	700 x 805 x 1150	10 GN 2/1 or 20 GN 1/1	60 mm	3000 W	230/1/50-60	• F0400003
ACR-1	700 x 805 x 1740	20 GN 2/1 or 40 GN 1/1	60 mm	3000 W	230/1/50-60	• F0400001
ACR-2	1350 x 805 x 1740	40 GN 2/1 or 80 GN 1/1	60 mm	4000 W	230/1/50-60	• F0400002

• 24-hour shipping

TEMPERATURE MAINTENANCE AND BAIN-MARIE TROLLEYS

ACG Heated Holding Trolley

NEW

General specifications

- **Designed to facilitate transporting hot foods.**
- Made of AISI grade 304 stainless steel (18/10).
- Capacity for 10 or 21 GN 2/1, depending on the model.
- Easy-to-use digital control panel.
- Moisture control using analog thermostat.
- Optimal performance thanks to insulation using CFC-free polyurethane injected at high pressure, which is 70 mm thick and has a density of 42 kg/m³.
- Interior with sanitary radius to facilitate cleaning.
- Heat preservation for up to 4 hours after disconnecting.
- Working temperature +35°C / +85°C.
- Door opens a total of 270 degrees.
- Long side handles for excellent mobility.
- Bumper consisting of a single polyethylene piece to prevent impact.
- Four Ø200 mm high-resistance castors (2 with brakes).
- Locking handle with key included.
- Spiral single-phase connecting cord with ground connection.
- Heat and moisture using heating elements and an in-chamber fan.
- Inlaid runners compatible with GN trays and containers.
- Distance between runners 57.5 mm.
- Grill racks and Gastronorm containers not included.



Gastronorm containers
Pg. 160



GN grill racks
Pg. 163



+35° / +85°

Model	Total dimensions (mm)	Capacity	Power (W)	Power supply (V/N/Hz)	Code
ACG-10	765 x 890 x 1035	GN 2/1 x 10	750	230/1/50-60	• F0400009
ACG-21	765 x 890 x 1740	GN 2/1 x 21	2000	230/1/50-60	• F0400008

• 24-hour shipping

ACGF Cold Holding Trolley

NEW

General specifications

- **Designed to facilitate transporting cold foods.**
- Made of AISI grade 304 stainless steel (18/10).
- Capacity of 19 GN 2/1.
- Easy-to-use digital control panel.
- Optimal performance thanks to insulation using CFC-free polyurethane injected at high pressure, which is 70 mm thick and has a density of 42 kg/m³.
- Interior with sanitary radius to facilitate cleaning.
- Working temperature -2°C / +8°C.
- Door opens a total of 270 degrees.
- Long side handles for excellent mobility.
- Bumper consisting of a single polyethylene piece to prevent impact.
- Four Ø200 mm high-resistance castors (2 with brakes).
- Locking handle with key included.
- Spiral single-phase connecting cord with ground connection.
- Automatic defrosting with heating element.
- Inlaid runners compatible with GN trays and containers.
- Distance between runners 57.5 mm.
- Grill racks and Gastronorm containers not included.

 **Gastronorm containers**
Page 160

 **GN grill racks**
Page 163

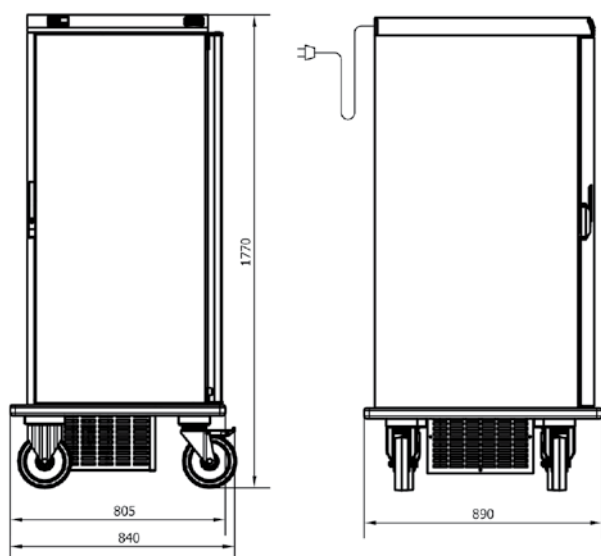

-2° / +8°

Model	Total dimensions (mm)	Capacity	Power (W)	Power supply (V/N/Hz)	Code
ACGF	890 x 765 x 1770	GN 2/1 x 19	400	230/1/50-60	• F0400010

• 24-hour shipping

TEMPERATURE MAINTENANCE AND BAIN-MARIE TROLLEYS

Hot and cold foods

NEW

GN Cold Holding Trolley

- For transporting cold foods during the service.
- Made of AISI grade 304 stainless steel (18/10).
- Basin with safety edges on all sides, for GN containers with a maximum depth of 150 mm.
- Drain with ball valve.
- Incorporates lighted switch and digital thermostat.
- Cold trolley designed especially for transporting foods requiring low temperatures for optimal food safety conditions.
- The sanitary radius makes cleaning more convenient.
- Four Ø125 mm swivel castors (2 with brakes, located on the handle side) and bumpers.
- Gastronorm containers not included.
- No assembly required.



 **Gastronorm containers**
Page 160

Total dimensions (mm)	Capacity	Power (W)	Power supply (V/Hz)	Code
840 x 676 x 850	2 GN 1/1	380	230/50-60	• F0420501
1060 x 676 x 880	3 GN 1/1	380	230/50-60	• F0420502

Trolley with Constant-level Hot Plate Dispenser

- For heating, transporting and supplying hot plates during service.
- Made of AISI grade 304 stainless steel (18/10).
- Lighted switch and adjustable 0-90°C thermostat.
- Trolley contains system for adjusting diameter for plates between Ø200 mm and Ø310 mm.
- Spring system helps keep plates at a constant height.
- Handles for easy transport are ergonomically positioned.
- Contains hole for releasing residual liquids inside trolley.
- Four Ø125 mm castors with bumpers (2 with brakes).
- Covers not included.
- No assembly required.



F1100711
Stainless steel cover.

Dimensions (mm)	Power (W)	Power supply (V/Hz)	Plate capacity	Diameter	Code
990 x 540 x 900	1600	230/50-60	130	Ø 200-310	• F0420311
Ø 368 x 140	-	-	-	-	• F1100711

• 3-day shipping

TEMPERATURE MAINTENANCE AND BAIN-MARIE TROLLEYS

Bains-marie

Bain-marie trolley

- For maintaining and transporting food at its optimal serving temperature.
- Made of AISI grade 304 stainless steel (18/10).
- Basin with safety edges for GN containers with a maximum depth of 200 mm.
- Drain with ball valve.
- Hidden silicone heating elements.
- Lighted switch and adjustable 0-90°C digital thermostat.
- Safety thermostat.
- Stainless steel lower shelf.
- Handles for easy transport are ergonomically positioned.
- Four Ø125 mm castors with bumpers (2 with brakes, placed on the side with the handles).
- No assembly required.

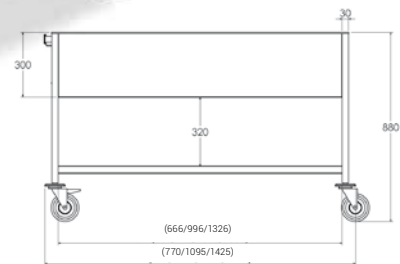

 **Gastronorm containers**
Page 160

Total dimensions(mm)	Capacity	Power (W)	Power supply (V/Hz)	Code
770 x 670 x 880	2 GN 1/1	1600	230/50-60	• F0420201
1095 x 670 x 880	3 GN 1/1	2400	230/50-60	• F0420202
1425 x 670 x 880	4 GN 1/1	3200	230/50-60	• F0420203

Bain-marie trolley with reserve tank

- For maintaining and transporting food at its optimal serving temperature.
- Made of AISI grade 304 stainless steel (18/10).
- Basin with safety edges on all sides, for GN containers with a maximum depth of 200 mm.
- Drain with ball valve.
- Hidden silicone heating elements with a lighted switch and thermostat for separately controlling reserve tank and bain-marie temperature.
- Four Ø125 mm swivel castors (2 with brakes, located on the handle side)
- The sanitary radius and concealed heating elements make cleaning more convenient.
- No assembly required.



 **Gastronorm containers**
Page 160

Total dimensions (mm)	Capacity	Power (W)	Power supply (V/Hz)	Code
830 x 675 x 850	2 GN 1/1	2350	230/50-60	• F0420211
1160 x 676 x 850	3 GN 1/1	3150	230/50-60	• F0420212

• 3-day shipping

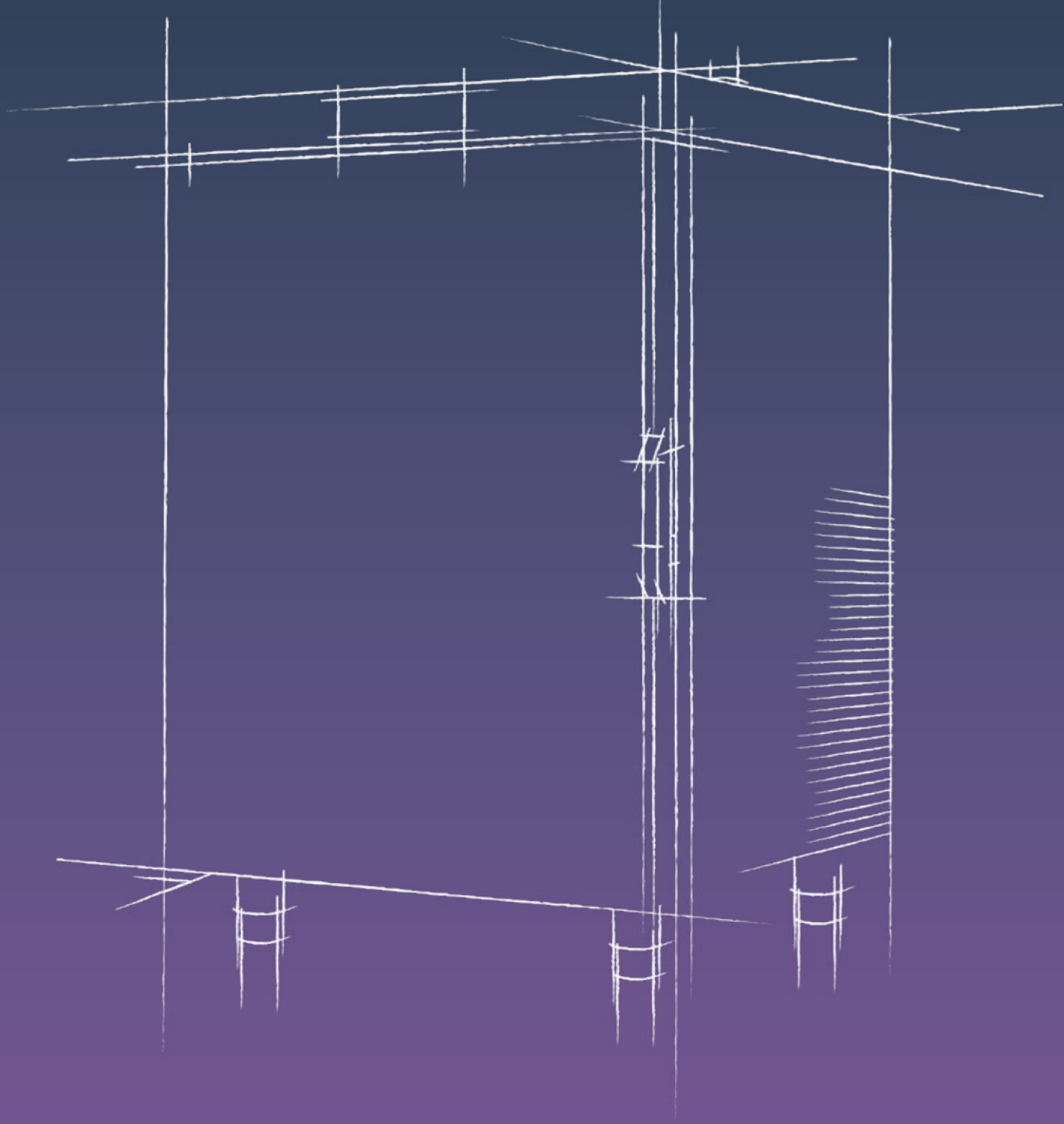

REGENERATION OVENS

Evoline

P. 154

REGENERATION OVENS

Evoline

Regeneration is a key process, since it is the last step in the food preparation chain before customers are served. Evoline regeneration ovens are made of reliable, robust technology that can be depended upon at any time.



Easy to use

In just two steps

The easy-to-understand control panel allows you to regenerate food in just minutes, no prior training required. Evoline is capable of regenerating food in just two steps, providing excellent results in terms of juiciness, color, and texture.



Speed

Regenerate food as quickly as possible

Evoline was designed so that the regeneration process can be carried out in the shortest time possible, thanks to its thermodynamic design and optional steam generation system, which makes Evoline the fastest regeneration oven on the market.



Minimal investment

High efficiency at a competitive price

You'll see energy savings thanks to a design that ensures perfect insulation in the chamber for the most efficient regeneration possible. The competitive price and minimum installation requirements give Evoline products a very fast return on investment.



Quality and safety

Regeneration with core probe

Regenerating foods with the help of a probe allows you reach the safety temperature at the food's core at just the right time. The thickness of the piece and original temperature of the pre-cooked product do not affect regeneration.

Control panel

Model with humidity control and probe connector



- A** Maintenance phase at 65°C*
- B** Regeneration at 140°C* using timer or probe
- C** Regeneration at 160°C* using timer or probe
- D** Humidity control from 0% to 99%
- E** Regeneration time / Probe temperature
- F** Power on/off

Model with humidity control, without probe connector

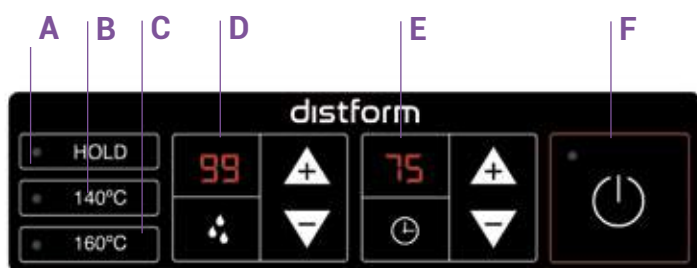

- A** Maintenance phase at 65°C*
- B** Regeneration at 140°C*
- C** Regeneration at 160°C*
- D** Humidity control from 0% to 99%
- E** Regeneration time
- F** Power on/off

Model without humidity control

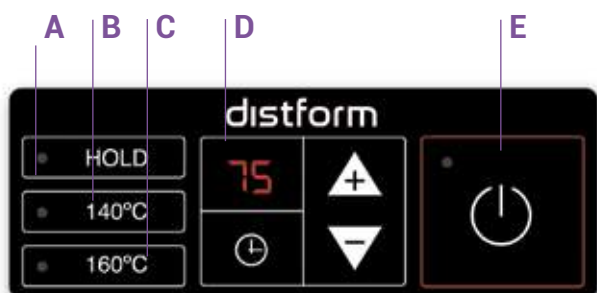

- A** Maintenance phase at 65°C*
- B** Regeneration at 140°C*
- C** Regeneration at 160°C*
- D** Regeneration time
- E** Power on/off

*Temperature can be adjusted by a service technician (range from 65°C to 160°C)

REGENERATION OVENS

Evoline



5GN 2/3

5GN 1/1

6GN 1/1

10GN 1/1

GN 1/1 Capacity	Exterior dimensions (mm)	Weight (kg)	Cap. EN 4	Portion capacity (200 g)	Dist. between runners (mm)	Power (kW)	Power supply (V/L+N/Hz)	Working temperature	Humidity control	Core probe	Code
5 GN 2/3	573 x 660 x 825	75	5	62.5	81	3.1	230/L+N/50-60	65-140-160*	–	–	● F0460523
5 GN 2/3	573 x 670 x 825	75	5	62.5	81	3.1	230/L+N/50-60	65-140-160*	YES	–	● F0470523
5 GN 2/3	573 x 670 x 825	75	5	62.5	81	3.1	230/L+N/50-60	65-140-160*	YES	YES	● FS470523
5 GN 1/1	743 x 661 x 825	85	10	100	81	3.6	230/L+N/50-60	65-140-160*	–	–	● F0460511
5 GN 1/1	743 x 723 x 825	102	10	100	81	5.1	400/3L+N/50-60	65-140-160*	–	–	● F0460512
5 GN 1/1	743 x 723 x 825	102	10	100	81	5.1	400/3L+N/50-60	65-140-160*	YES	–	● F0470512
5 GN 1/1	743 x 723 x 825	102	10	100	81	5.1	400/3L+N/50-60	65-140-160*	YES	YES	● FS470512
6 GN 1/1	773 x 728 x 890	118	12	120	81	7.8	400/3L+N/50-60	65-140-160*	–	–	● F0460611
6 GN 1/1	773 x 728 x 890	118	12	120	81	7.8	400/3L+N/50-60	65-140-160*	YES	–	● F0470611
6 GN 1/1	773 x 728 x 890	118	12	120	81	7.8	400/3L+N/50-60	65-140-160*	YES	YES	● FS470611
10 GN 1/1	773 x 729 x 1250	136	20	200	81	10.5	400/3L+N/50-60	65-140-160*	–	–	● F0461011
10 GN 1/1	773 x 729 x 1250	136	20	200	81	10.5	400/3L+N/50-60	65-140-160*	YES	–	● F0471011
10 GN 1/1	773 x 729 x 1250	136	20	200	81	10.5	400/3L+N/50-60	65-140-160*	YES	YES	● FS471011

* The three working temperature settings (65, 140, and 160) can be configured by an authorized service technician (within a range of 65° C - 160° C).

● 24-hour shipping

● 6-day shipping

Regeneration oven accessories

Optional*

Model	Code
Door opens from right side	• F0467015

* Evoline regeneration oven are manufactured according to your selection of optional features. These must be requested when placing your order.

Supports

For model	Code
5 GN 2/3	• F0467010
5 GN 1/1 single-phase	• F0467011
5 GN 1/1 three-phase	• F0467012
6 GN 1/1	• F0467013
10 GN 1/1	• F0467014

 **Gastronorm containers**
Page 160

 **GN grill racks**
Page 163



• 24-hour shipping

• 6-day shipping

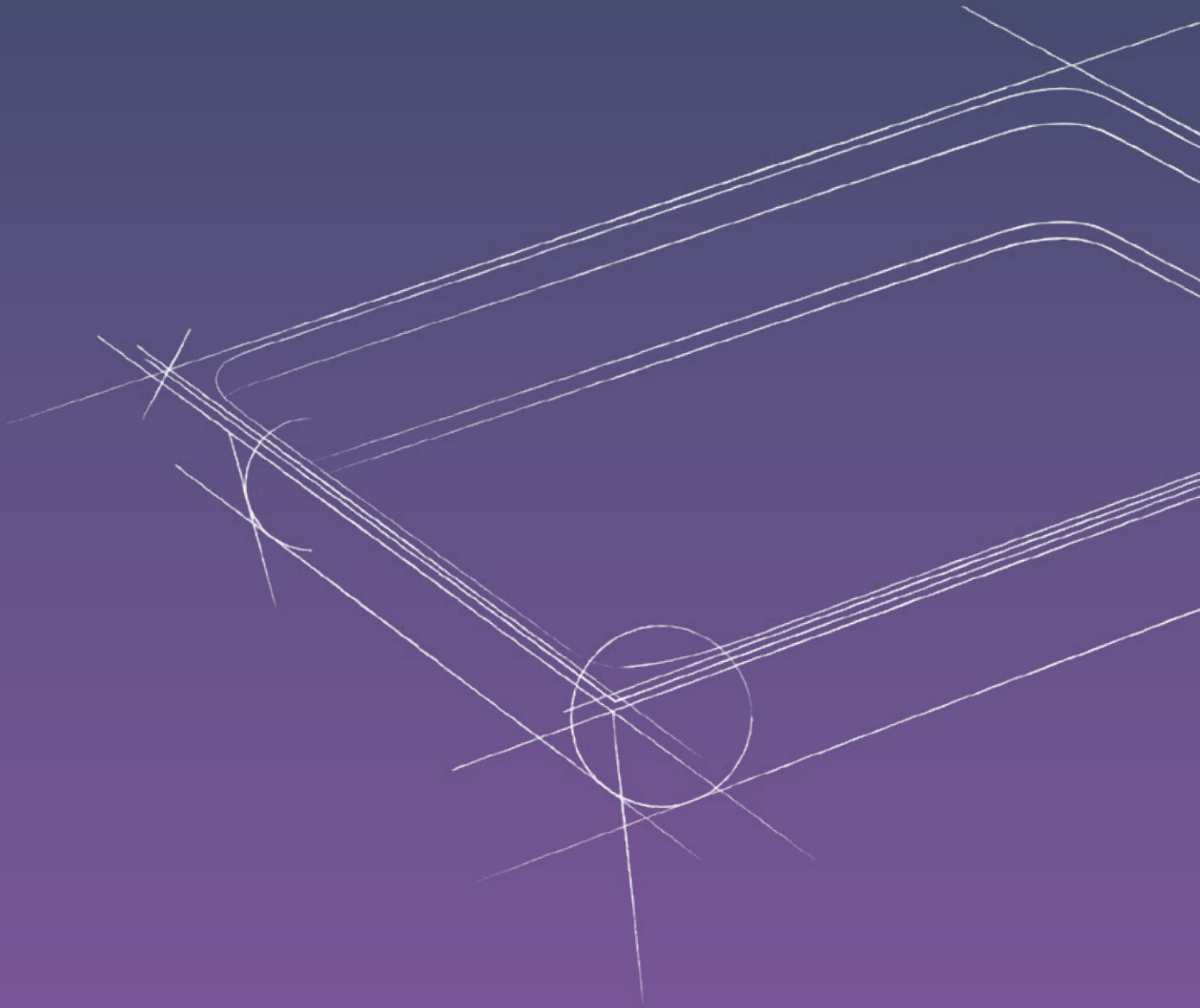

GASTRONORM CONTAINERS

Smooth GN containers	P. 160
GN containers with handles	P. 161
Perforated GN containers	P. 162
GN Accessories	P. 163

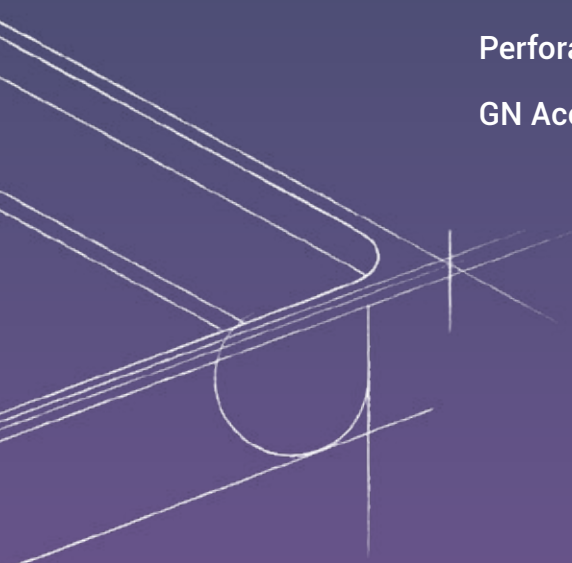





GASTRONORM CONTAINERS

Smooth Gastronorm containers

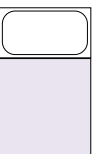
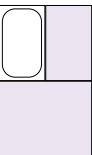
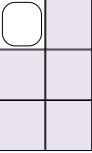
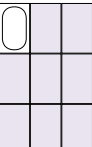

• Made of AISI 304 stainless steel (18/10), very sturdy and with reinforced edges.

Model	Dimensions	Depth (mm)	Capacity (liters)	Code			
2/1		650 x 530	200	52.00	• RGN21200		
		150	43.10	• RGN21150			
		100	28.90	• RGN21100			
		65	18.80	• RGN21060			
		40	11.50	• RGN21040			
		20	6.20	• RGN21020			
1/1		325x530	200	26.00	• RGN11200		
		150	20.20	• RGN11150			
		100	14.20	• RGN11100			
		65	8.30	• RGN11060			
		40	5.10	• RGN11040			
		20	2.80	• RGN11020			
2/3		325x352	200	18.30	• RGN23200		
		150	13.20	• RGN23150			
		100	8.80	• RGN23100			
		65	5.60	• RGN23065			
		40	3.10	• RGN23040			
		20	1.70	• RGN23020			
1/2		325x265	200	12.00	• RGN12200		
		150	9.10	• RGN12150			
		100	6.10	• RGN12100			
		65	4.10	• RGN12065			
		40	2.20	• RGN12040			
		20	1.20	• RGN12020			
1/3		325x176	200	7.30	• RGN13200		
		150	5.60	• RGN13150			
		100	3.80	• RGN13100			
		65	2.50	• RGN13065			
		40	1.50	• RGN13040			
		20	0.80	• RGN13020			
1/4		265x162	200	5.00	• RGN14200		
		150	4.10	• RGN14150			
		100	2.80	• RGN14100			
		65	1.70	• RGN14065			
		20	0.50	• RGN14020			
		1/6		176x162	200	2.90	• RGN16200
150	2.20			• RGN16150			
100	1.60			• RGN16100			
65	1.00			• RGN16065			
1/9				170x108	100	0.80	• RGN19100
				65	0.60	• RGN19065	

• 24-hour shipping

Gastronorm containers with moveable vertical handles

- Made of AISI 304 stainless steel (18/10), very sturdy and with reinforced edges.
- Retractable handles facilitate handling and stacking.



Model	Dimensions	Depth (mm)	Capacity (liters)	Code
2/1 	650 x 530	200	52.00	• RGN2120A
		150	43.10	• RGN2115A
		100	28.90	• RGN2110A
		65	18.80	• RGN2106A
		40	11.50	• RGN2104A
1/1 	325x530	200	26.00	• RGN1120A
		150	20.20	• RGN1115A
		100	14.20	• RGN1110A
		65	8.30	• RGN1106A
		40	5.10	• RGN1104A
2/3 	325x352	200	18.30	• RGN2320A
		150	13.20	• RGN2315A
		100	8.80	• RGN2310A
		65	5.60	• RGN2306A
		40	3.10	• RGN2304A
		20	1.70	• RGN2302A
1/2 	325x265	200	12.00	• RGN1220A
		150	9.10	• RGN1215A
		100	6.10	• RGN1210A
		65	4.10	• RGN1206A
		40	2.20	• RGN1204A
1/3 	325x176	200	7.30	• RGN1320A
		150	5.60	• RGN1315A
		100	3.80	• RGN1310A
		65	2.50	• RGN1306A
		40	1.50	• RGN1304A
1/4 	265x162	200	5.00	• RGN1420A
		150	4.10	• RGN1415A
		100	2.80	• RGN1410A
		65	1.70	• RGN1406A
1/6 	176x162	200	2.90	• RGN1620A
		150	2.20	• RGN1615A
		100	1.60	• RGN1610A
		65	1.00	• RGN1606A

• 24-hour shipping

GASTRONORM CONTAINERS

Perforated Gastronorm containers

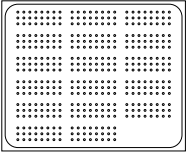
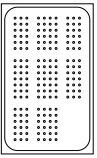
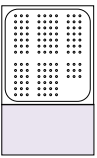
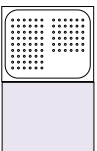

- Made of AISI 304 stainless steel (18/10), very sturdy and with reinforced edges.
- Perforated Gastronorm containers make it easier to drain foods.

Model	Dimensions	Depth (mm)	Capacity (liters)	Code
2/1 	650 x 530	200	52.00	● RGN2120F
		150	43.10	● RGN2115F
		100	28.90	● RGN2110F
		65	18.80	● RGN2106F
		40	11.50	● RGN2104F
		20	6.20	● RGN2102F
1/1 	325x530	200	26.00	● RGN1120F
		150	20.20	● RGN1115F
		100	14.20	● RGN1110F
		65	8.30	● RGN1106F
		40	5.10	● RGN1104F
		20	2.80	● RGN1102F
2/3 	325x352	200	18.30	● RGN2320F
		150	13.20	● RGN2315F
		100	8.80	● RGN2310F
		65	5.60	● RGN2306F
		40	3.10	● RGN2304F
		20	1.70	● RGN2302F
1/2 	325x265	200	12.00	● RGN1220F
		150	9.10	● RGN1215F
		100	6.10	● RGN1210F
		65	4.10	● RGN1206F

Perforated bottom

- To separate or drain foods from the bottom of the basin.



For basins	Code
GN 2/1	● RFOND21A
GN 1/1	● RFOND11A
GN 2/3	● RFOND23A
GN 1/2	● RFOND12A
GN 1/3	● RFOND13A
GN 1/4	● RFOND14A

● 24-hour shipping

GASTRONORM CONTAINERS

GN Accessories

Dividers

- To divide gastronorm containers and maximize their surface area.



Model	Dimensions (mm)	Code
1/1	325	• F1120601
2/1	530	• F1120602

Gastronorm lids

- Working temperature range: -40°C to +110°C.



Silicone detail



Lid

Model	Code
1/1	• RTAPA110
2/3	• RTAPA230
1/2	• RTAPA120
1/3	• RTAPA130
1/4	• RTAPA140
1/6	• RTAPA160
1/9	• RTAPA190

Lid with holes for handles

Model	Code
1/1	• RTAPA11A
2/3	• RTAPA23A
1/2	• RTAPA12A
1/3	• RTAPA13A
1/4	• RTAPA14A
1/6	• RTAPA16A

Airtight lid with silicone

Model	Code
1/1	• RTAPA11S
1/2	• RTAPA12S
1/3	• RTAPA13S
1/4	• RTAPA14S
1/6	• RTAPA16S

Gastronorm Grill Racks

- Made of stainless steel.



Model	Dimensions(mm)	Code
2/1	645 x 530	• RPARGN21
1/1	530 x 325	• RPARGN11
2/3	352 x 325	• RPARGN23

• 24-hour shipping

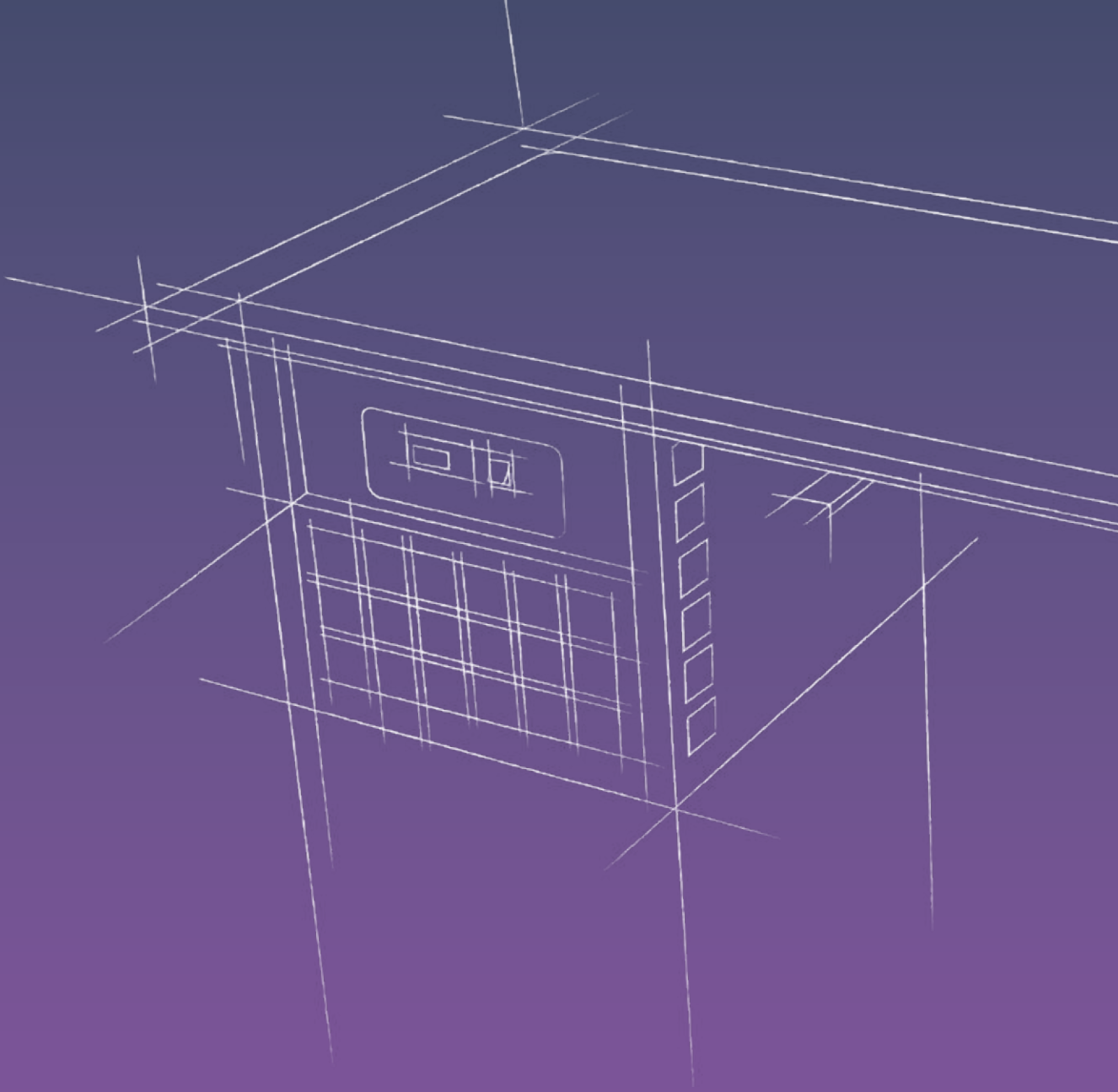

DROP-IN

Cold elements **P. 164**

Hot elements **P. 175**

Accessories **P. 178**

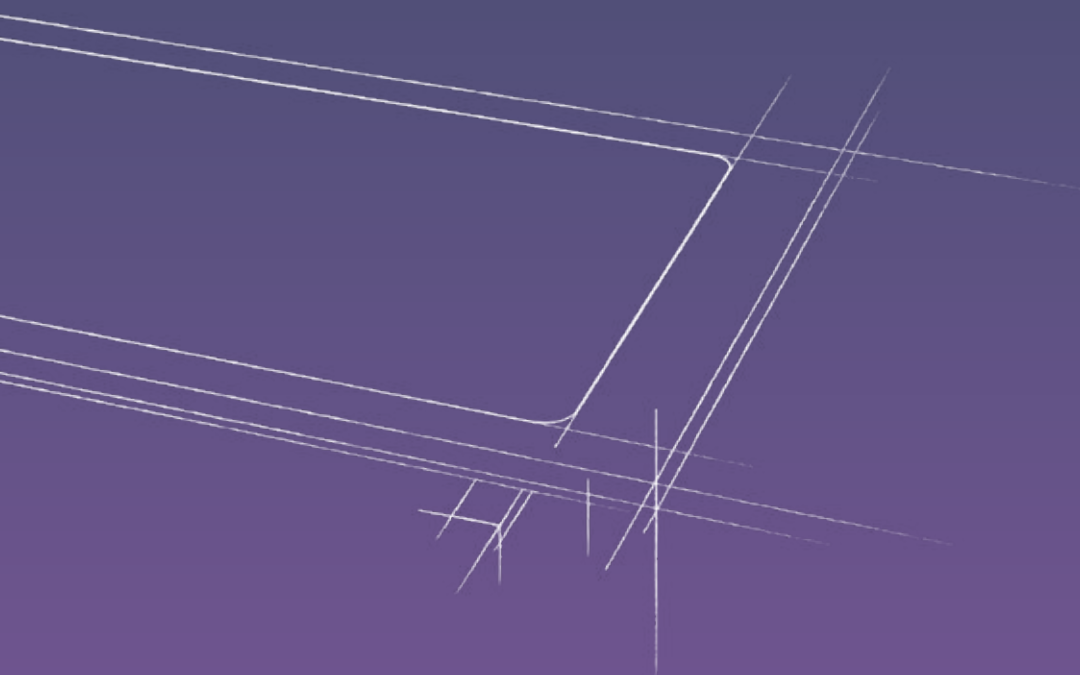

DROP-IN EVERYTHING YOU NEED FOR ANY PROJECT



- Made of AISI 304 stainless steel (18/10) with safety edges to facilitate cleaning.
- Easy to attach to the countertop.



- Control panel integrated into the drop-in; can be removed for exterior assembly. Easy front and rear access.



- State-of-the-art design of supports, which can be easily installed in the drop-in.

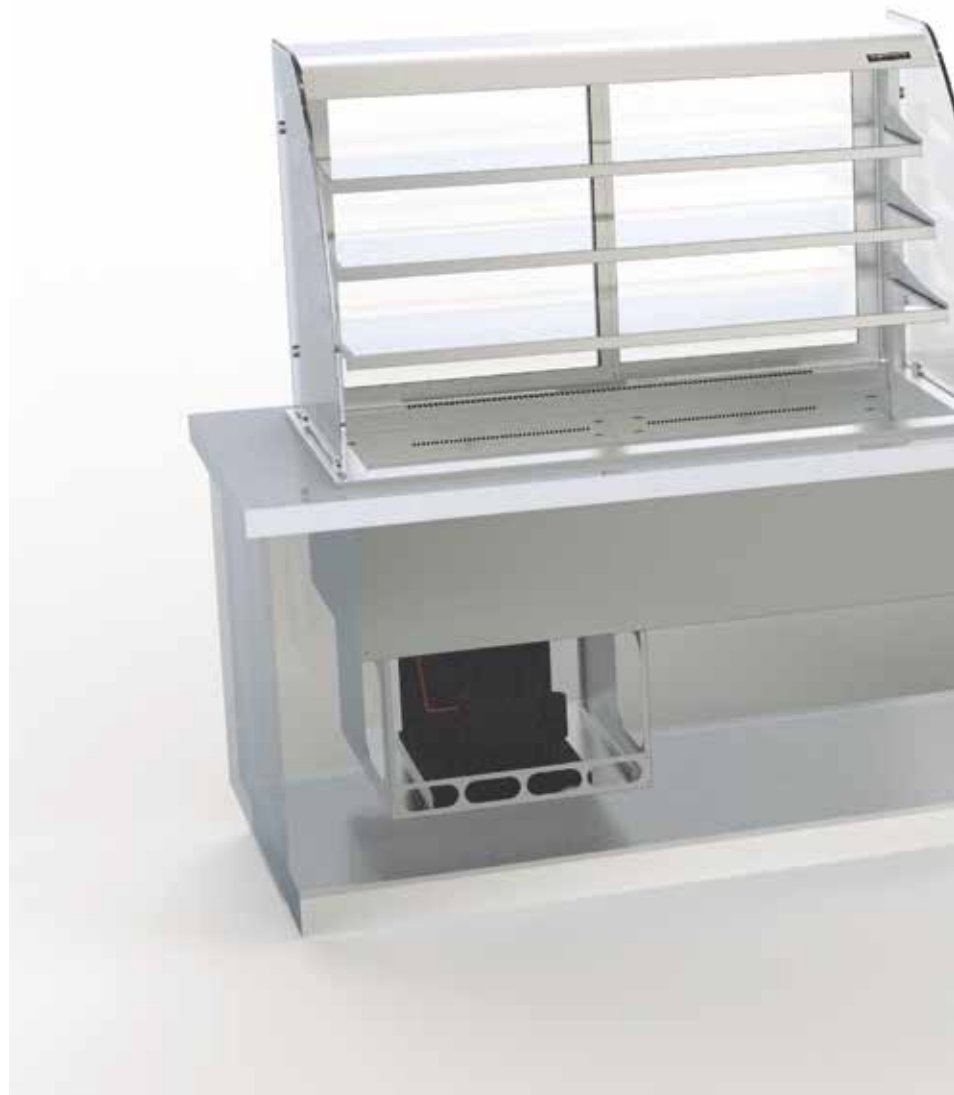

**NEW DESIGN FOR VERY STURDY SUPPORTS,
WHICH FACILITATE DROP-IN INSTALLATION IN
ANY TYPE OF UNIT**

The full range

Our wide range of built-in elements allows for maximum personalization of the unit to your environment, whether it be a hotel, café, or school, based on your display and preservation needs. All drop-in models are available in standard GN dimensions (except the frozen food tub).

Meeting quality standards

Made with an AISI 304 stainless steel structure and rounded edges on the inside of the food tubs. All drop-in elements are designed to ensure maximum sanitation and to meet the highest standards.



Energy efficiency

The design of the drop-in elements allows for high operational performance. This efficiency means lower energy consumption, thanks to better distribution of temperature and the use of state-of-the-art insulation, which helps to prevent temperature loss.

Glass display cases

Thanks to the refrigeration system's design, which generates and distributes cold air from the lower part of the glass display case to the upper part, and which has an air diffusing effect between each shelf, the inside of the glass display case will reach a fully even temperature. Foldable screens maintain temperature right up until food is served.

DROP-IN Cold elements

NEW

Ice strip

- For maintaining and displaying cold dishes or beverages at the correct temperature during food service.
- AISI 304 stainless steel (18/10) with safety edges to facilitate cleaning.
- Extruded polystyrene insulation.
- Refrigerated using copper cooling coil in the base.
- Working temperature of -15°C to -18°C.
- Easy to attach to the countertop using the hardware included.

Models with control panel group included:

- Control panel with digital switchboard and lighted switch integrated into the drop-in. Can be removed for exterior assembly.
- R-404a refrigerant
- Working temperature of -15°C to -18°C.



Control panel group not included

GN capacity	Total dimensions (mm)	Total built-in dimensions (mm)	Recommended power (cv)	Code
2 GN	770 x 610 x 60	740 x 580 x 45	1/4	• PF000002
3 GN	1100 x 610 x 60	1070 x 580 x 45	1/4	• PF000003
4 GN	1430 x 610 x 60	1400 x 580 x 45	1/3	• PF000004
5 GN	1760 x 610 x 60	1730 x 580 x 45	1/2	• PF000005

With control panel group included

GN capacity	Total dimensions (mm)	Total built-in dimensions (mm)	cv	Cooling capacity (W)	Power supply (V/Hz)	Code
2 GN	770 x 610 x 440	740 x 580 x 460	1/4	380	230/50	• PFG00002
3 GN	1100 x 610 x 440	1070 x 580 x 460	1/4	380	230/50	• PFG00003
4 GN	1430 x 610 x 440	1400 x 580 x 460	1/3	480	230/50	• PFG00004
5 GN	1760 x 610 x 440	1730 x 580 x 460	1/2	720	230/50	• PFG00005

• 3-day shipping

NEW

Two-level ice strip

- For maintaining and displaying cold dishes or beverages at the correct temperature during food service.
- The 2 levels improve the visibility and display of foods.
- AISI 304 stainless steel (18/10) with safety edges to facilitate cleaning.
- Extruded polystyrene insulation.
- Refrigerated using copper cooling coil in the base.
- Working temperature of -15°C to -18°C.
- Easy to attach to the countertop using the hardware included.

Models with control panel group included:

- Control panel with digital switchboard and lighted switch integrated into the drop-in. Can be removed for exterior assembly.
- R-404a refrigerant
- Working temperature of -15°C to -18°C.



Control panel group not included

GN capacity	Total dimensions (mm)	Total built-in dimensions (mm)	Recommended power (cv)	Code
3 GN	1100 x 610 x 130	1070 x 580 x 45	1/4	• PF020003
4 GN	1430 x 610 x 130	1400 x 580 x 45	1/3	• PF020004
5 GN	1760 x 610 x 130	1730 x 580 x 45	1/2	• PF020005

With control panel group included

GN capacity	Total dimensions (mm)	Total built-in dimensions (mm)	cv	Cooling capacity (W)	Power supply (V/Hz)	Code
3 GN	1100 x 610 x 512	1070 x 580 x 460	1/4	380	230/50	• PFG20003
4 GN	1430 x 610 x 512	1400 x 580 x 460	1/3	480	230/50	• PFG20004
5 GN	1760 x 610 x 512	1730 x 580 x 460	1/2	720	230/50	• PFG20005

• 3-day shipping

DROP-IN Cold elements

NEW

Stationary cold food tub

- For maintaining and displaying cold dishes or beverages at the correct temperature during food service.
- Made of AISI 304 stainless steel (18/10).
- For GN containers with a maximum depth of 150 mm.
- Drain included.
- Extruded polystyrene insulation.
- Refrigerated using copper cooling coil in the base.
- Working temperature of 0°C / +4°C.
- Easy to attach to the countertop using the hardware included.

Models with control panel group included:

- Control panel with digital switchboard and lighted switch integrated into the drop-in. Can be removed for exterior assembly.



Control panel group not included

GN capacity	Total dimensions (mm)	Total built-in dimensions (mm)	Recommended power (cv)	Code
3 GN	1100 x 610 x 215	1070 x 580 x 230	1/5	• CF010003
4 GN	1430 x 610 x 215	1400 x 580 x 230	1/4	• CF010004
5 GN	1760 x 610 x 215	1730 x 580 x 230	3/8	• CF010005

With control panel group included

GN capacity	Total dimensions (mm)	Total built-in dimensions (mm)	cv	Cooling capacity (W)	Power supply (V/Hz)	Code
3 GN	1100 x 610 x 610	1070 x 580 x 620	1/5	380	230/50	• CFG10003
4 GN	1430 x 610 x 610	1400 x 580 x 620	1/4	480	230/50	• CFG10004
5 GN	1760 x 610 x 610	1730 x 580 x 620	3/8	720	230/50	• CFG10005

• 3-day shipping

Frozen food tub

For maintaining and displaying frozen, packaged, or bulk foods during service.

- Made of AISI 304 stainless steel (18/10).
- Capacity for 4 frozen food containers (not included) measuring 360 x 165 x 150 mm.
- Transparent protective sliding lids.
- Extruded polystyrene insulation.
- Refrigerated using copper cooling coil in the base.
- R-404 refrigerant recommended.
- Drain included.

- Working temperature of -15°C to -18°C.
- Easy to attach to the countertop using the hardware included.

Models with control panel group included:

- Control panel with digital switchboard and lighted switch integrated into the drop-in. Can be removed for exterior assembly.

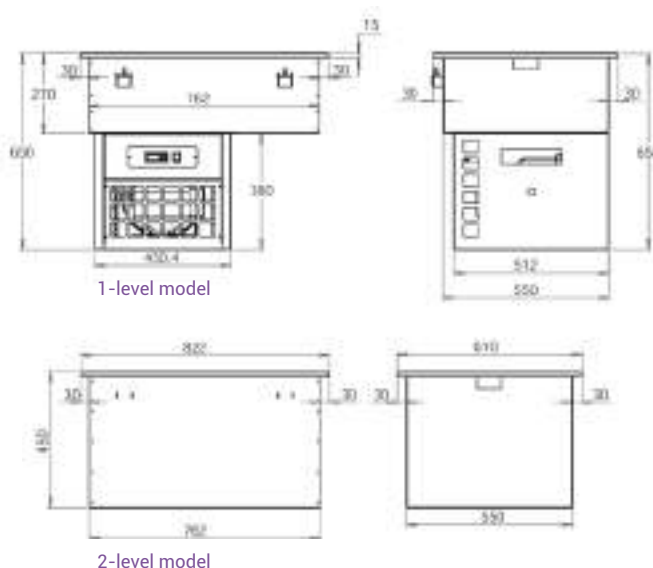

Control panel group not included

Model	Total dimensions (mm)	Total built-in dimensions (mm)	Capacity	Recommended power (cv)	Code
Prof 150 mm 1 level	822 x 610 x 270	790 x 570 x 270	4 of 5 l.	1/3	• CH010004
Prof 150 mm 2 levels	822 x 610 x 450	790 x 570 x 450	4+4 of 5 l.	1/2	• CH020004

With control panel group included

Model	Total dimensions (mm)	Total built-in dimensions (mm)	Capacity	cv	Cooling capacity (W)	Power supply (V/Hz)	Code
Prof 150 mm 1 level	822 x 610 x 650	790 X 570 X 650	4 of 5 l.	1/3	350	230/50	• CHG10004

• 3-day shipping

DROP-IN Cold elements

Open glass display case with 3 levels and tub

- For maintaining and displaying cold dishes or beverages at the correct temperature during food service.
- Made of AISI 304 stainless steel (18/10).
- Extruded polystyrene insulation.
- 200-mm-deep basin.
- Drain included.
- Customers can access food from the front of the unit.
- Food can be restocked from the rear of the unit using the glass sliding doors.
- Working temperature of +7°C / 10°C in room temperature of 25°C.
- Foldable thermo-screen facing customers helps to maintain temperatures when food is not being served.
- Forced air refrigeration system uses R404A refrigerant.
- Glass display case equipped with tempered side glass.
- Overhead LED lighting.
- Easy to attach to the countertop using the hardware included.
- Power supply: 230 V/1/50 Hz.

Model with control panel group included:

- Control panel with digital switchboard and lighted switch integrated into the drop-in. Can be removed for exterior assembly.

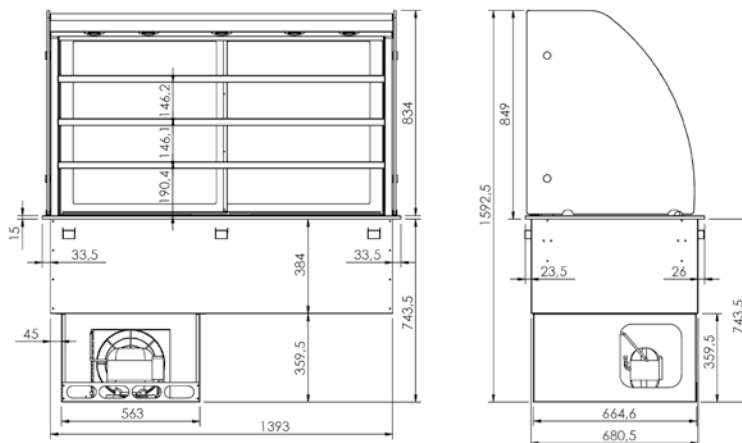

With control panel group included

Capacity	Total dimensions (mm)	Total built-in dimensions (mm)	CV	Cooling capacity (W)	Power supply (V/Hz)	Code
4GN 1/1	1460 x 730 x 1600	1430 x 700 x 780	3/4	720	230/50	• F1100502

• 6-day shipping

Refrigerated glass display case, 3 levels

- For maintaining and displaying cold dishes or beverages at the correct temperature during food service.
- Made of AISI 304 stainless steel (18/10).
- Drain included.
- Open front access for customers via swinging methacrylate doors.
- Food can be restocked from the rear of the unit using the glass sliding doors.
- Working temperature of +8°C / 10°C in room temperature of 25°C.
- Ventilated refrigeration and hermetic compressor with R-134-A refrigerant.

- Glazed glass display case with 3 surfaces and 3 removable shelves.
- Overhead LED lighting.

Models with control panel group included:

- Control panel with digital switchboard and lighted switch.



Glass display case without base.



Glass display case with base.

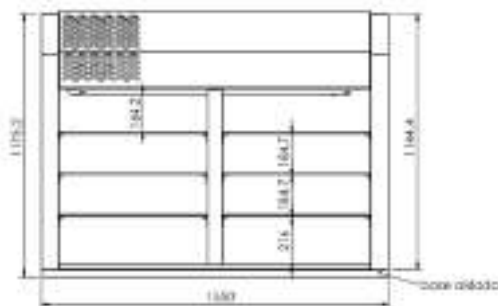
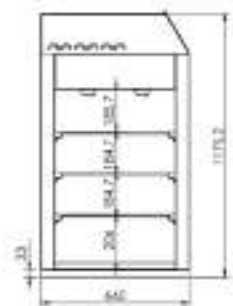

With control panel group included

Model	Capacity	Total dimensions (mm)	cv	Cooling capacity (W)	Power supply (V/Hz)	Code
Without base	4GN 1/1	1550 x 660 x 1150	1/3	800	230/50	• S1001001
With insulated base	4GN 1/1	1550 x 660 x 1180	1/3	800	230/50	• S1001002

• 6-day shipping

DROP-IN Cold elements

Refrigerated glass display case with 3 levels and a basin

- For maintaining and displaying cold dishes or beverages at the correct temperature during food service.
- Made of AISI 304 stainless steel (18/10).
- Drain included.
- Open front access for customers via swinging methacrylate doors.
- Food can be restocked from the rear of the unit using the glass sliding doors.
- Working temperature of +8°C / 10°C in room temperature of 25°C.
- Ventilated refrigeration and hermetic compressor with R-134-A refrigerant.
- Glazed glass display case with 3 surfaces and 3 removable shelves.
- Overhead LED lighting.
- Easy to attach to the countertop using the hardware included.

Model with control panel group included:

- Control panel with digital switchboard and lighted switch integrated into the drop-in. Can be removed for exterior assembly.

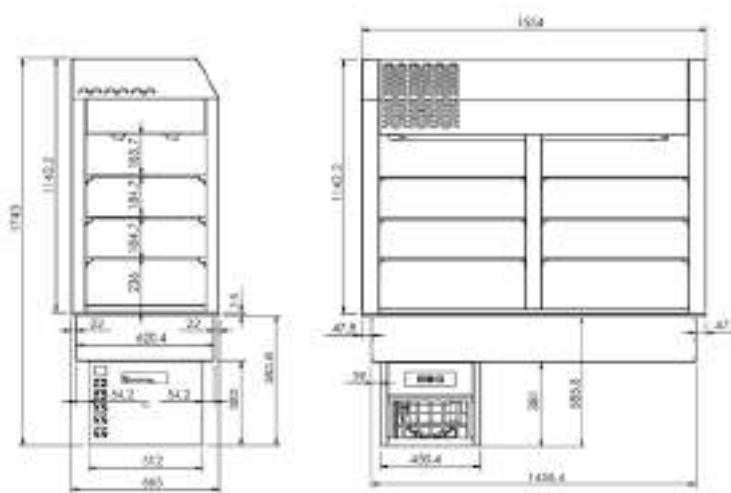

With control panel group included

Capacity	Total dimensions (mm)	Total built-in dimensions (mm)	cv	Cooling capacity (W)	Power supply (V/Hz)	Code
4GN 1/1	1550 x 660 x 1750	1340 x 560 x 570	1/3 - 1/4	1280	230/50	• F1101002

• 6-day shipping

DROP-IN Hot elements

NEW

Bain-marie basin

- For maintaining and displaying hot foods at the correct temperature during food service.
- Basin made of AISI 304 stainless steel (18/10) with safety edges to facilitate cleaning.
- For GN containers with a maximum depth of 150 mm.
- Drain with ball valve included.
- Hidden silicone heating elements with safety thermostat included.
- Digital thermostat 0°C/90°C is used for regulating and controlling temperature.
- Easy to attach to the countertop using the hardware included.

Model with control panel group included:

- Control panel with digital switchboard and lighted switch integrated into the drop-in. Can be removed for exterior assembly.

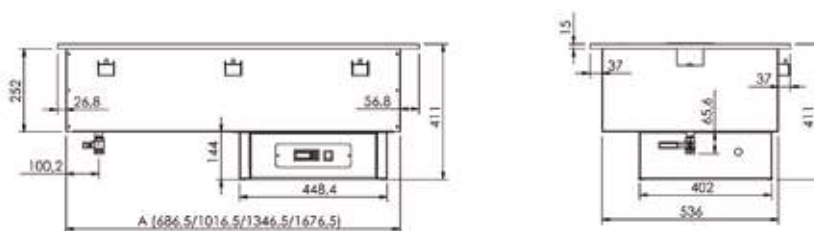

Capacity	Total dimensions (mm)	Total built-in dimensions (mm)	Power (W)	Power supply (V/Hz)	Code
2 GN 1/1	770 x 610 x 415	740 x 580 x 430	1600	230/50-60	• BMH10002
3 GN 1/1	1100 x 610 x 415	1070 x 580 x 430	2400	230/50-60	• BMH10003
4 GN 1/1	1430 x 610 x 415	1400 x 580 x 430	3200	230/50-60	• BMH10004
5 GN 1/1	1760 x 610 x 415	1730 x 580 x 430	4000	230/50-60	• BMH10005

• 3-day shipping

DROP-IN Hot elements

NEW

Stationary dry food tub

- For maintaining and displaying hot foods at the correct temperature during food service.
- For GN containers with a maximum depth of 100 mm.
- Heating elements hidden in removeable perforated false bottom to facilitate cleaning.
- Temperature is regulated and controlled using digital thermostat 0°C/90°C.
- Control panel with digital switchboard and lighted switch integrated into the drop-in. Can be removed for exterior assembly.
- Safety thermostat included.
- Easy to attach to the countertop using the hardware included.

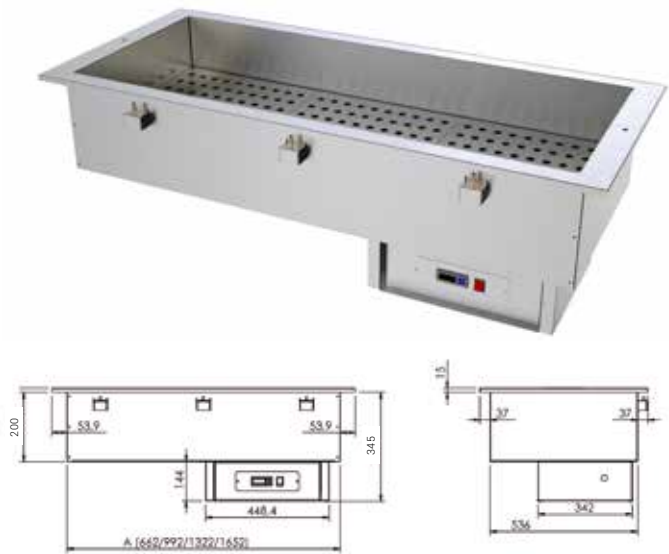

Capacity	Total dimensions (mm)	Total built-in dimensions (mm)	Power (W)	Power supply (V/Hz)	Code
2 GN 1/1	770 x 610 x 360	740 x 580 x 370	1200	230/50-60	• BMS10002
3 GN 1/1	1100 x 610 x 360	1070 x 580 x 370	2000	230/50-60	• BMS10003
4 GN 1/1	1430 x 610 x 360	1400 x 580 x 370	2400	230/50-60	• BMS10004
5 GN 1/1	1760 x 610 x 360	1730 x 580 x 370	2800	230/50-60	• BMS10005

Tempered glass hot plate

- For maintaining and displaying hot foods at the correct temperature during food service.
- Made of AISI 304 stainless steel (18/10).
- 6-mm-thick tempered glass.
- Temperature is regulated and controlled using digital thermostat 0°C/90°C.
- Control panel with digital switchboard and lighted switch integrated into the drop-in. Can be removed for exterior assembly.
- Hidden silicone heating elements.
- Safety thermostat included.
- Easy to attach to the countertop using the hardware included.



Capacity	Total dimensions (mm)	Total built-in dimensions (mm)	Power (W)	Power supply (V/Hz)	Code
2 GN 1/1	770 x 610 x 200	740 x 580 x 60	900	230/50-60	• PCT00002
3 GN 1/1	1100 x 610 x 200	1070 x 580 x 60	1350	230/50-60	• PCT00003
4 GN 1/1	1430 x 610 x 200	1400 x 580 x 60	1800	230/50-60	• PCT00004
5 GN 1/1	1760 x 610 x 200	1730 x 580 x 60	2250	230/50-60	• PCT00005

• 3-day shipping

Tempered glass hot plate without frame

- **For maintaining and displaying hot foods at the correct temperature during food service.**
- Made of AISI 304 stainless steel (18/10).
- 6-mm-thick tempered glass.
- Temperature is regulated and controlled using digital thermostat 0°C/90°C.
- Control panel with digital switchboard and lighted switch integrated into the drop-in. Can be removed for exterior assembly.
- Hidden silicone heating elements.
- Safety thermostat included.
- Easy to attach to the countertop using the hardware included.



Capacity	Total dimensions (mm)	Total built-in dimensions (mm)	Power (W)	Power supply (V/Hz)	Code
2 GN 1/1	624 x 504 x 60	600 x 480 x 60	900	230/50-60	• PCTM0002
3 GN 1/1	954 x 504 x 60	930 x 480 x 60	1350	230/50-60	• PCTM0003
4 GN 1/1	1284 x 504 x 60	1260 x 480 x 60	1800	230/50-60	• PCTM0004
5 GN 1/1	1614 x 504 x 60	1590 x 480 x 60	2250	230/50-60	• PCTM0005

Tempered glass hot plate countertop

- **Specially designed for hot buffet food service areas.**
- Can be combined with strip warmer F1100130.
- Made of AISI 304 stainless steel (18/10).
- 6-mm-thick tempered glass.
- Analog thermostat ranging from 0°C to 90°C regulates temperature.
- Analog thermostat and lighted switch.
- Hidden silicone heating elements.
- Safety thermostat included.
- 1.5 m connecting cord with plug.



Total dimensions (mm)	Power (W)	Power supply (V/Hz)	Code
500 x 500 x 100	800	230/50-60	• PCTS0002
650 x 550 x 100	800	230/50-60	• PCTS0003
1000 x 500 x 100	1600	230/50-60	• PCTS0004

Strip warmer

- **Helps warm foods that need to be heated from above.**
- Ideal complement to a countertop hot plate.

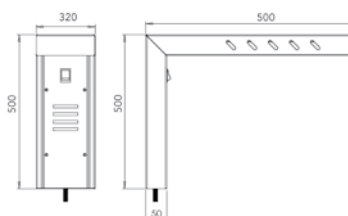

Model	Total dimensions (mm)	Power (W)	Power supply (V/Hz)	Code
With a threaded plug	500 x 320 x 500	300	230/50	• F1100130
With a base	500 x 320 x 500	300	230/50	• PIMC0002

• 3-day shipping

DROP-IN Accessories

Hot plate dispenser

- **Raises dishes to a constant height so they are accessible for removal.**
- Springs allow you to regulate the height of dishes.
- Capacity of 65 plates.
- Diameter of the dispenser can be adjusted from 200 mm to 310 mm.
- Analog thermostat ranging from 0°C to 90°C controls temperature.
- 2m connecting cord with plug.
- Mobile control panel with analog thermostat and lighted switch.



Hot plate dispenser



Neutral plate dispenser



SST cover

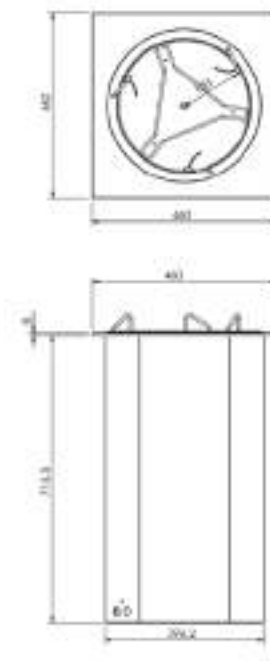

Model	Total dimensions (mm)	Total built-in dimensions (mm)	Power (W)	Power supply (V/Hz)	No. of plates	Code
Hot	460 x 460 x 800	410 x 410 x 730	800	230/50-60	65	• F1100701
Neutral	Ø 425 x 735	Ø 410	-	-	65	• F1100702
Lid	Ø 368 x 140	-	-	-	-	• F1100711

Neutral dish rack dispenser

- Made of AISI 304 stainless steel (18/10).
- Tools for attaching to the countertop are included.
- Capacity: Six 110 mm racks or ten 50 mm racks.
- Maximum load of 200 kg.

Total dimensions (mm)	Total built-in dimensions (mm)	Code
590 x 590 x 750	560 x 560 x 750	• F1100703



• 3-day shipping

Supports with screens

- Made of AISI grade 304 stainless steel (18/10).
- Screens with light: LED lighting.
- Screens with light and heat: halogen lighting and heating.
- Direct assembly over the drop-in.

SUPPORTS, SCREENS, AND GLASS SOLD SEPARATELY

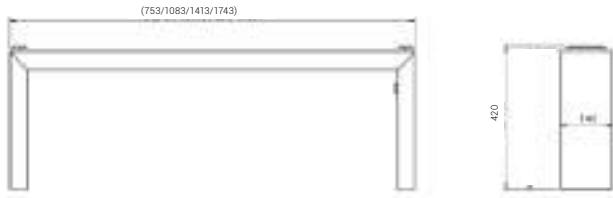

Neutral support
Support with screen

Capacity	Neutral support	LED light *	Power (W)	Halogen light and heat *	Power (W)	Halogen light and ceramic heat*	Power (W)
2 GN 1/1	• SNJ00002	• SLJ00002	8	• SLCJ0002	600	• SLIJ0002	620
3 GN 1/1	• SNJ00003	• SLJ00003	12	• SLCJ0003	600	• SLIJ0003	990
4 GN 1/1	• SNJ00004	• SLJ00004	14	• SLCJ0004	900	• SLIJ0004	1360
5 GN 1/1	• SNJ00005	• SLJ00005	18	• SLCJ0005	1200	• SLIJ0005	1730

* Power supply (V/Hz) 230/50–60

Digital thermometer

- To display the working temperature of the drop-in.
- Ideal for one- or two-level ice strips, cold and frozen food tubs, hot food tubs and hot plates.
- Easy to install in any support or screen.

Code

- SLT00001



Glass

- Tempered safety glass to protect food safety.



Two-surface curved glass

Capacity	Total dimensions (mm)	Code
2 GN 1/1	582 x 550	• FCRC02GN
3 GN 1/1	912 x 550	• FCRC03GN
4 GN 1/1	1242 x 550	• FCRC04GN
5 GN 1/1	1572 x 550	• FCRC05GN



Front glass

Capacity	Total dimensions (mm)	Code
2 GN 1/1	582 X 340	• FCRF02GN
3 GN 1/1	912 x 340	• FCRF03GN
4 GN 1/1	1242 x 340	• FCRF04GN
5 GN 1/1	1572 X 340	• FCRF05GN

• 3-day shipping

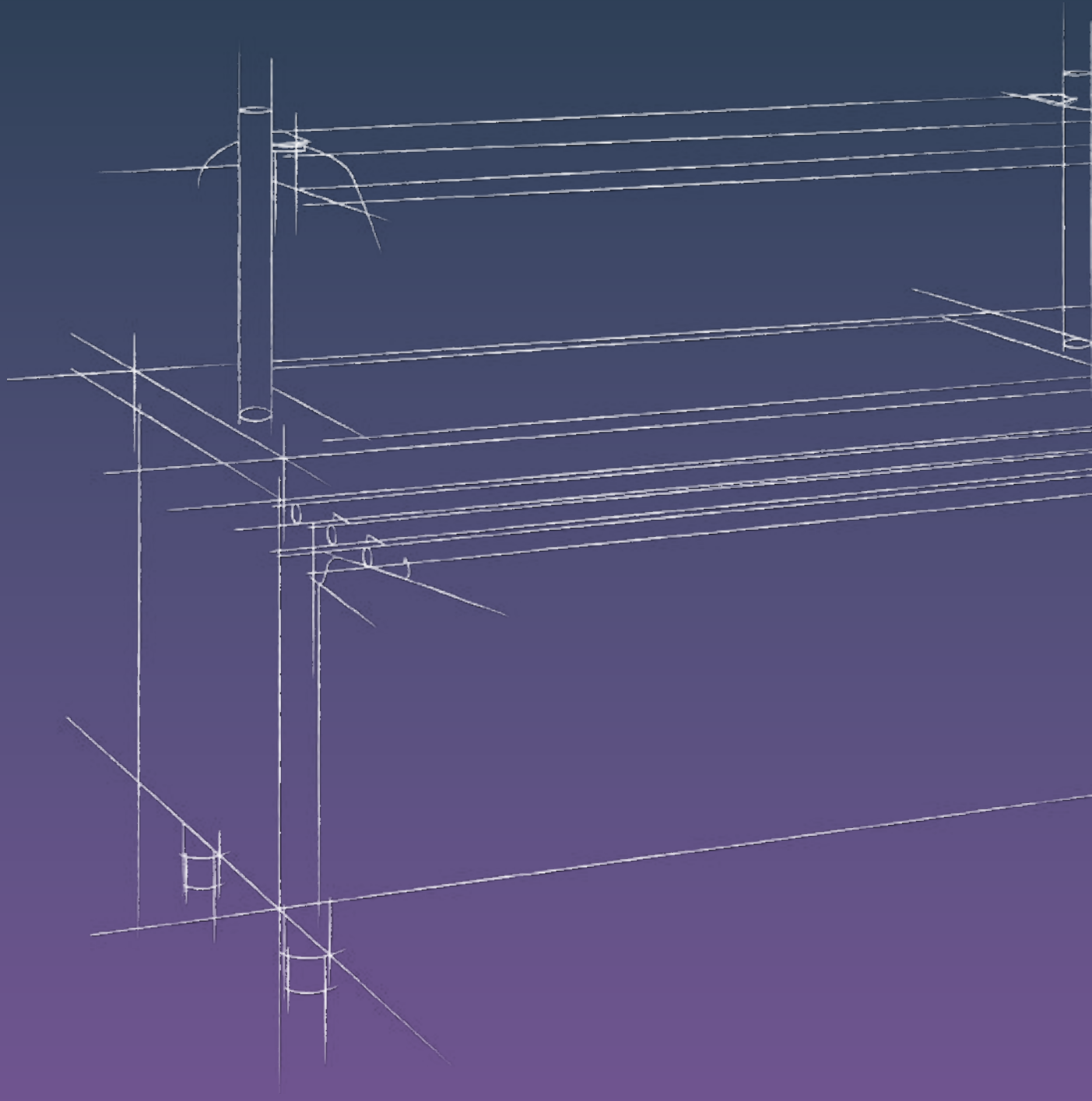

A technical drawing of a building structure, showing a cross-section of a roof and walls. The drawing is composed of white lines on a dark blue background. It depicts a roof with a central ridge and several supporting beams. Below the roof, there are vertical lines representing walls or columns, and a small rectangular structure at the bottom left, possibly a window or door. The drawing is partially obscured by the text on the right.

SELF-SERVICE SATURNO

Cold elements	P. 184
Hot elements	P. 188
Neutral elements	P. 192
Accessories	P. 196

SATURNO MODULAR SOLUTIONS FOR SELF-SERVICE

Adaptability

Saturno's series of self-service products uses a modular design for services using **center islands** or forming multi-purpose, **versatile food lines**. With many different possibilities among the various models (cold, neutral or hot) and available functions, Saturno's self-service products will satisfy the needs of any project.

- Made of top-quality AISI 304 stainless steel (18/10)



- Countertop with 65 mm rounded finish front piece, fully welded.
- Removable side and front panels (for cold elements) to facilitate access to the inside of the unit.
- Digital thermostat for regulating and controlling temperature.



- Screens with light or light and heat with double-sided curved glass and rounded tube supports (optional).
- Refrigerated glass display cases with three levels, capacity for 4 GN or 6 GN.
- Tubular stainless steel tray slides (optional).



- Decorative panels in solid colors or with a wood finish allow you to personalize your order. See pg. 200 - 201.



Functionality and appearance

Designed to allow you to present food to your customers in an attractive and ergonomic way, based on the type of food. Each element is carefully designed to **enhance the appearance of the food** at the stations and in the display cases.

Maximum personalization

Distform's self-service products are known for their **sturdiness, functionality, and high-quality finishes.**

The ability to choose from among the 7 available colors (solid colors or wood-grain finish) is just one example of our **varied customization options.**

Energy efficiency

High performance in heating and cooling units thanks to applied engineering and the use of **environmentally-friendly, HFC-free** polystyrene foam insulation. Better distribution and temperature maintenance, meaning **more efficient energy consumption.**



Easy installation

Independent modules and easy access to the inside area of the Saturno self-service stations allow for **quick and easy installation** that adapts to the needs of your business.

**GREAT RANGE OF
COMBINATIONS FOR
HOTELS, HOSPITALS,
SERVICE STATIONS,
CAMPSITES AND CAFÉS**

SELF-SERVICE Cold elements

Self-service cold plate

- **For maintaining and displaying cold dishes or beverages at the correct temperature during food service.**
- Made of AISI grade 304 stainless steel (18/10).
- Countertop with 65 mm front piece with rounded finish, fully welded.
- Coil refrigeration and hermetic compressor with R-134-A refrigerant.
- For best refrigeration results, there should be sufficient distance between the front/rear part of the unit and other nearby items that could hinder the performance of the condenser unit.
- Insulated with eco-friendly, HFC-free polystyrene foam.
- Digital thermostat for regulating and controlling temperature.
- 150 mm legs allow you to raise the height of the unit from 850 to 900 mm.
- Removable side panels for easy access to electrical area and compressor.
- Removable front piece for easy access to the compressor.
- Stainless steel front panel, decorative panel optional.

Models with refrigerated reserve cabinet

- Copper evaporator coil with aluminium fins.
- Reserve temperature of +4°C in room temperature of 25°C.
- Extruded polystyrene insulation.
- Reserve cabinet has 4 or 6 runners (removable for easy cleaning) for GN 1/1 containers.
- Tray slides, screen, and glass not included.

 **Supports and glass**
Page 199

 **Tray slides**
Page 198

 **Decorative panels**
Page 200



Without reserve cabinet

Capacity	Total dimensions (mm)	Power (W)	Power supply (V/Hz)	Code
3 GN 1/1	1200 x 700 x 850	480	230/50	• S1001201
4 GN 1/1	1600 x 700 x 850	720	230/50	• S1001202
6 GN 1/1	2300 x 700 x 850	1030	230/50	• S1001205

With refrigerated reserve cabinet

Capacity	Total dimensions (mm)	Power (W)	Power supply (V/Hz)	Code
4 GN 1/1	1600 x 700 x 850	720	230/50	• S1001302
6 GN 1/1	2300 x 700 x 850	1030	230/50	• S1001305



• 6-day shipping

Self-service cold food tub

- **For maintaining and displaying cold dishes or beverages at the correct temperature during food service.**
- Made of AISI grade 304 stainless steel (18/10).
- Countertop with 65 mm front piece with rounded finish, fully welded.
- Basin has safety edges to facilitate cleaning.
- For GN containers with a maximum depth of 150 mm.
- Coil refrigeration and hermetic compressor with R-134-A refrigerant.
- For best refrigeration results, there should be sufficient distance between the front/rear part of the unit and other nearby items that could hinder the performance of the condenser unit.
- Insulated with eco-friendly, HFC-free polystyrene foam.
- Digital thermostat for regulating and controlling temperature.
- 150 mm legs allow you to raise the height of the unit from 850 to 900 mm.
- Removable side panels for easy access to electrical area and compressor.
- Removable front piece for easy access to the compressor.
- Stainless steel front panel, decorative panel optional.

Models with refrigerated reserve cabinet

- Copper evaporator coil with aluminium fins.
- Reserve temperature of +4°C in room temperature of 25°C.
- Extruded polystyrene insulation.
- Reserve cabinet has 4 or 6 runners (removable for easy cleaning) for GN 1/1 containers.
- Tray slides, screen, and glass not included.

 **Supports and glass**
Page 199

 **Tray slides**
Page 198

 **Decorative panels**
Page 200



Without reserve cabinet

Capacity	Total dimensions (mm)	Power (W)	Power supply (V/Hz)	Code
3 GN 1/1	1200 x 700 x 850	380	230/50	• S1001701
4 GN 1/1	1600 x 700 x 850	480	230/50	• S1001702
6 GN 1/1	2300 x 700 x 850	720	230/50	• S1001705

With refrigerated reserve cabinet

Capacity	Total dimensions (mm)	Power (W)	Power supply (V/Hz)	Code
4 GN 1/1	1600 x 700 x 850	480	230/50	• S1001101
6 GN 1/1	2300 x 700 x 850	720	230/50	• S1001105



• 6-day shipping

SELF-SERVICE Cold elements

Center island: cold plate or cold tub

- **For maintaining and displaying cold dishes or beverages at the correct temperature during food service.**
- Made of AISI 304 stainless steel (18/10).
- Countertop with 65 mm front piece with rounded finish, fully welded.
- Coil refrigeration and hermetic compressor with R-134-A refrigerant.
- For best refrigeration results, there should be sufficient distance between the front/rear part of the unit and other nearby items that could hinder the performance of the condenser unit.
- Insulated with eco-friendly, HFC-free polystyrene foam.
- Digital thermostat for regulating and controlling temperature.
- 150 mm legs allow you to raise the height of the unit from 850 to 900 mm.
- Removable side panels for easy access to electrical area and compressor.
- 2 stainless steel front panels, optional decorative panels.
- Tray slides, plate support, screen, and glass not included.

Center island cold food tub:

- Basin has safety edges to facilitate cleaning.
- For GN containers with a maximum depth of 150 mm.

 **Supports and glass**
Page 199

 **Tray slides**
Page 198

 **Decorative panels**
Page 200



Model	Total dimensions (mm)	Capacity	Power (W)	Power supply (V/Hz)	Code
Cold plate	1600 x 700 x 850	4 GN 1/1	720	230/50	• S1001203
Cold food tub	1600 x 700 x 850	4 GN 1/1	480	230/50	• S1001703
Side support for plates	520 x 330				• S1001733

• 6-day shipping

Refrigerated glass display case with 3 levels

- For maintaining and displaying cold dishes or beverages at the correct temperature during food service.
- Made of AISI 304 stainless steel (18/10).
- Glazed glass with 3 surfaces and sliding doors on rear of unit; interior lighting, three shelves and swinging methacrylate doors.
- General switch and adjustable digital thermostat.
- Working temperature of +10°C in room temperature of +25°C.
- Can be adapted to neutral or cold units.
- Ventilated refrigeration and hermetic compressor with R-134-A refrigerant.

- For best refrigeration results, there should be sufficient distance between the front/rear part of the unit and other nearby items that could hinder the performance of the condenser unit.
- Space for hermetic compressor, refrigerant in upper portion.
- Side glass with chamber.
- Sliding doors in laminated glass.
- Cold food tub and tray slide not included.

 **Tray slides**
Page 198

 **Decorative panels**
Page 200



Without base

Capacity	Total dimensions (mm)	Power (W)	Power supply (V/Hz)	Code
4 GN 1/1	1550 x 660 x 1150	800	230/50	• S1001001
6 GN 1/1	2280 x 660 x 1150	800	230/50	• S1001011



With insulated base

Capacity	Total dimensions (mm)	Power (W)	Power supply (V/Hz)	Code
4 GN 1/1	1550 x 660 x 1150	800	230/50	• S1001002
6 GN 1/1	2280 x 660 x 1150	800	230/50	• S1001012



• 6-day shipping

SELF-SERVICE Hot elements

Bain-marie self-service unit

- **For maintaining and displaying hot foods at the correct temperature during food service.**
- Made of AISI grade 304 stainless steel (18/10).
- Countertop with 65 mm front piece with rounded finish, fully welded.
- Basin has safety edges to facilitate cleaning.
- For GN containers with a maximum depth of 200 mm.
- Indirectly heats water via silicone heating elements located in the bottom of the tub.
- Silicone heating elements improve performance and reduce energy usage.
- Digital thermostat ranging from 0°C to 90°C regulates temperature of the bain-marie.
- 1/2" water intake and drain pipes with ball valve are ergonomically positioned.
- 150 mm legs allow you to raise the height of the unit from 850 to 900 mm.
- Safety thermostat.
- Removable side panels for easy access to electrical area and plumbing.
- Stainless steel front panel, decorative panel optional.
- Tray slides, screen, and glass not included.

 **Supports and glass**
Page 199

 **Tray slides**
Page 198

 **Decorative panels**
Page 200



Without reserve cabinet

Capacity	Total dimensions (mm)	Power (W)	Power supply (V/Hz)	Code
3 GN 1/1	1200 x 700 x 850	2400	230/50-60	• S1000601
4 GN 1/1	1600 x 700 x 850	3200	230/50-60	• S1000602
6 GN 1/1	2300 x 700 x 850	4800	380/50-60	• S1000605



With hot reserve cabinet

Capacity	Total dimensions (mm)	Power (W)	Power supply (V/Hz)	Code
3 GN 1/1	1200 x 700 x 850	4400	230/50-60	• S1000701
4 GN 1/1	1600 x 700 x 850	5200	230/50-60	• S1000702
6 GN 1/1	2300 x 700 x 850	7800	380/50-60	• S1000705



• 6-day shipping

Dry bain-marie self-service unit

- **For maintaining and displaying hot foods at the correct temperature during food service.**
- Made of AISI grade 304 stainless steel (18/10).
- Countertop with 65 mm front piece with rounded finish, fully welded.
- For GN containers with a maximum depth of 150 mm.
- Digital thermostat ranging from 0°C to 90°C regulates temperature of the bain-marie.
- 150 mm legs allow you to raise the height of the unit from 850 to 900 mm.
- Safety thermostat.
- Removable side panels for easy access to electrical area.
- Perforated false bottom protects heating elements.
- Stainless steel front panel, decorative panel optional.
- Tray slides, screen, and glass not included.

 **Supports and glass**
Page 199

 **Tray slides**
Page 198

 **Decorative panels**
Page 200



Without reserve cabinet

Capacity	Total dimensions (mm)	Power (W)	Power supply (V/Hz)	Code
3 GN 1/1	1200 x 700 x 850	1200	230/50-60	• S1000501
4 GN 1/1	1600 x 700 x 850	1600	230/50-60	• S1000502
6 GN 1/1	2300 x 700 x 850	2400	230/50-60	• S1000505



With hot reserve cabinet

Capacity	Total dimensions (mm)	Power (W)	Power supply (V/Hz)	Code
3 GN 1/1	1200 x 700 x 850	3200	230/50-60	• S1001511
4 GN 1/1	1600 x 700 x 850	3600	230/50-60	• S1001512
6 GN 1/1	2300 x 700 x 850	5400	380/50-60	• S1001515



• 6-day shipping

SELF-SERVICE Hot elements

Self-service tempered glass

- For maintaining and displaying hot foods at the correct temperature during food service.
- Made of AISI grade 304 stainless steel (18/10).
- Countertop with 65 mm front piece with rounded finish, fully welded.
- 150 mm legs allow you to raise the height of the unit from 850 to 900 mm.
- Stainless steel front panel, decorative panel optional.
- Digital thermostat included in all models.
- Silicone heating elements improve performance and reduce energy usage.
- Safety thermostat.
- Removable side panels for easy access.
- Tray slides not included.



Without reserve cabinet

Capacity	Total dimensions (mm)	Power (W)	Power supply (V/Hz)	Code
3 GN 1/1	1200 x 700 x 850	2400	230/50-60	• S1001813
4 GN 1/1	1600 x 700 x 850	3200	230/50-60	• S1001814



With hot reserve cabinet

Capacity	Total dimensions (mm)	Power (W)	Power supply (V/Hz)	Code
3 GN 1/1	1200 x 700 x 850	4400	230/50-60	• S1001823
4 GN 1/1	1600 x 700 x 850	5200	230/50-60	• S1001824



Self-service unit with hot reserve cabinet

- Designed to accommodate catering or food units that do not require temperature regulation.
- Hot reserve cabinet inside the unit.
- Made of AISI grade 304 stainless steel (18/10).
- Countertop with 65 mm front piece with rounded finish, fully welded.
- 150 mm legs allow you to raise the height of the unit from 850 to 900 mm.
- Stainless steel front panel, decorative panel optional.
- Perforated middle shelf facilitates even distribution of temperature.
- Digital thermostat included in all models.
- Safety thermostat.
- Removable side panels for easy access.
- Tray slides not included.



Capacity	Total dimensions (mm)	Power (W)	Power supply (V/Hz)	Code
3 GN 1/1	1200 x 700 x 850	2000	230/50-60	• S1001801
4 GN 1/1	1600 x 700 x 850	3000	230/50-60	• S1001802



• 6-day shipping

Center Island: with bain-marie or dry heat bain-marie or tempered glass

- For maintaining and displaying hot foods at the correct temperature during food service.
- Made of AISI 304 stainless steel (18/10).
- Countertop with 65 mm front piece with rounded finish, fully welded.
- Safety thermostat.
- Removable side panels for easy access to electrical area.
- Digital thermostat ranging from 0°C to 90°C regulates temperature of the bain-marie.
- 150 mm legs allow you to raise the height of the unit from 850 to 900 mm.
- 2 stainless steel front panels, optional decorative panels.
- Tray slides, plate support, screen and glass not included.

Center island with bain-marie

- Basin has safety edges to facilitate cleaning.
- For GN containers with a maximum depth of 200 mm.
- Indirectly heats water via silicone heating elements located in the bottom of the tub.
- 1/2" water intake and drain pipes with ball valve.

Center island with dry heat bain-marie

- For GN containers with a maximum depth of 150 mm.
- Perforated false bottom protects heating elements.

Center Island with Tempered Glass

- Silicone heating elements improve performance and reduce energy usage.

 **Supports and glass**
Page 199

 **Tray slides**
Page 198

 **Decorative panels**
Page 200

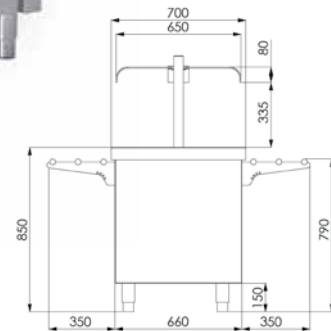
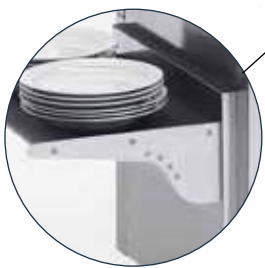

Center island

Model	Total dimensions (mm)	Capacity	Power (W)	Power supply (V/Hz)	Code
Center Island with Tempered Glass	1600 x 700 x 850	4 GN 1/1	3200	230/50-60	• S1000815
Center island with dry heat bain-marie	1600 x 700 x 850	4 GN 1/1	1600	230/50-60	• S1000503
Center island with bain-marie	1600 x 700 x 850	4 GN 1/1	3200	230/50-60	• S1000603
Side support for plates	520 x 330				• S1001733

• 6-day shipping

SELF-SERVICE Neutral elements

Neutral self-service unit

- Designed to accommodate catering or food units that do not require temperature regulation.
- Made of AISI grade 304 stainless steel (18/10).
- Countertop with 65 mm front piece with rounded finish, fully welded.
- 150 mm legs allow you to raise the height of the unit from 850 to 900 mm.
- Stainless steel front panel, decorative panel optional.
- Stainless steel middle shelf.
- Tray slides, screen, and glass not included.

 **Supports and glass**
Page 199

 **Tray slides**
Page 198

 **Decorative panels**
Page 200

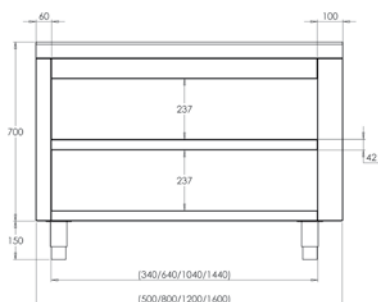

With shelf

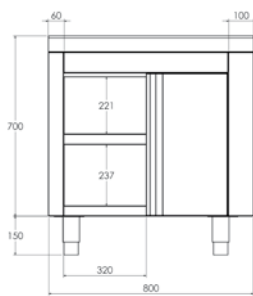

Swinging doors

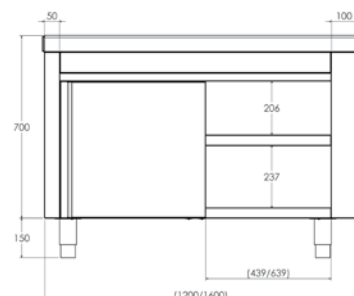

Sliding doors



With shelf

Total dimensions (mm)	Code
500 x 700 x 850	• S1000300
800 x 700 x 850	• S1000301
1200 x 700 x 850	• S1000302
1600 x 700 x 850	• S1000303

With doors and shelf

Model	Total dimensions (mm)	Code
Swinging doors	800 x 700 x 850	• S1000311
Sliding doors	1200 x 700 x 850	• S1000312
Sliding doors	1600 x 700 x 850	• S1000313

• 6-day shipping

Corner unit for self-service

- For joining two self-service units at a corner. Forms interior and exterior angles of 90° and 45°.
- Made of AISI grade 304 stainless steel (18/10).
- Countertop with 65 mm front piece with rounded finish, fully welded.
- 150 mm legs allow you to raise the height of the unit from 850 to 900 mm.
- Stainless steel front panel, decorative panel optional.

 **Tray slides**
Page 198

 **Decorative panels**
Page 200



S1000411

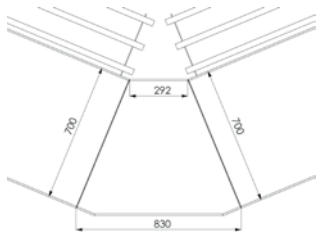

S1000412

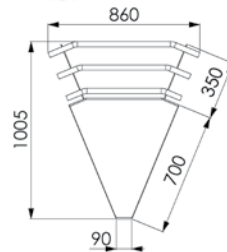

S1000401

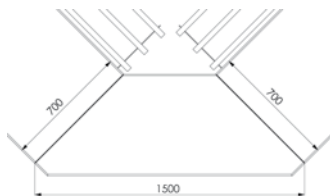

S1000402

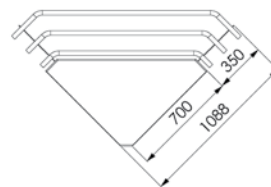

Interior

Model	Total dimensions (mm)	Code
45°	830 x 680 x 850	• S1000411
90°	1500 x 560 x 850	• S1000401

- Includes middle shelf.
- Tray slides not required.

Exterior

Model	Total dimensions (mm)	Code
45°	620 x 690 x 850	• S1000412
90°	1060 x 570 x 850	• S1000402

- Tray slides not included.

• 6-day shipping

SELF-SERVICE Neutral elements

Self-service cash register

- **Designed for cash register areas.**
- Made of AISI grade 304 stainless steel (18/10).
- Countertop with 65 mm front piece with rounded finish, fully welded.
- 150 mm legs allow you to raise the height of the unit from 850 to 900 mm.
- Stainless steel front panel, decorative panel optional.
- Comes with one drawer.
- Tray slides not included.

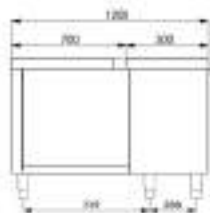

Raised self-service cash register

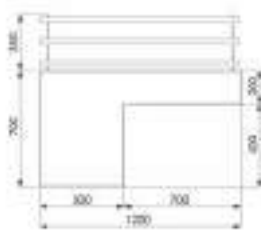

Freestanding self-service cash register left

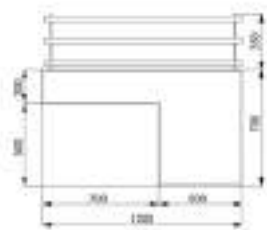

Freestanding self-service cash register right



Model	Total dimensions (mm)	Code
Self-service cash register right	1200 x 700 x 850	• S1001401
Self-service cash register left	1200 x 700 x 850	• S1001402

 **Tray slides**
Page 198

 **Decorative panels**
Page 200

Self-service neutral dish rack dispenser

- **Used for distributing glasses and cups in standard dish racks.**
- Made of AISI grade 304 stainless steel (18/10).
- Countertop with 65 mm front piece with rounded finish, fully welded.
- 150 mm legs allow you to raise the height of the unit from 850 to 900 mm.
- Stainless steel front panel, decorative panel optional.
- Approximate capacity: Six 110 mm racks or ten 50 mm racks.
- Tray slides not included.

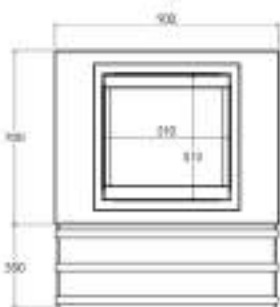

Total dimensions (mm)	Code
900 x 700 x 850	• S1001920

 **Tray slides**
Page 198

 **Decorative panels**
Page 200

• 6-day shipping

Self-service unit for Plate Dispenser Trolley

- **Designed to position one self-service constant-level plate dispenser.**
- Made of AISI grade 304 stainless steel (18/10).
- Countertop with 65 mm front piece with rounded finish, fully welded.
- 150 mm legs allow you to raise the height of the unit from 850 to 900 mm.
- Stainless steel front panel, decorative panel optional.
- Includes outlet to connect to plate dispenser.
- Tray slides not included.

 **Tray slides**
Page 198

 **Decorative panels**
Page 200

Total dimensions (mm)

Code

1300 x 700 x 850

• S1001930



S1001930 + F0420311 + F1100711 +
F1100711

F0420311 + F1100711 +
F1100711

Self-service constant-level plate dispenser

- **For distributing warm plates at a constant level.**
- Made of AISI grade 304 stainless steel (18/10).
- Countertop with 65 mm front piece with rounded finish, fully welded.
- 150 mm legs allow you to raise the height of the unit from 850 to 900 mm.
- Stainless steel front panel, decorative panel optional.
- Adjustable diameter from Ø200 to Ø310 mm.
- Tray slides and stainless steel covers not included.

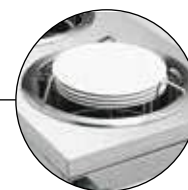

Single

Model	Total dimensions (mm)	Capacity	Power (W)	Power supply (V/Hz)	Code
Neutral	500 x 700 x 850	65 plates	-	-	• S1001901
Hot	500 x 700 x 850	65 plates	800	230/50-60	• S1001911
SST cover	Ø 368 x 140	-	-	-	• F1100711



Double

Model	Total dimensions (mm)	Capacity	Power (W)	Power supply (V/Hz)	Code
Neutral	1000 x 700 x 850	130 plates	-	-	• S1001902
Hot	1000 x 700 x 850	130 plates	1600	230/50-60	• S1001912
SST cover	Ø 368 x 140	-	-	-	• F1100711



• 6-day shipping

SELF-SERVICE Accessories

Utensil, glass and tray dispenser

- Made of AISI grade 304 stainless steel (18/10).
- 200-mm-deep GN 2/1 bread pan.
- Capacity for 6 GN 1/3 containers or 2 GN 1/1 containers for utensils.
- Shelves come attached to the structure and can be interchanged.
- Adjustable 150 mm stainless steel legs.

Freestanding

Total dimensions (mm)	Code
800 x 700 x 1500	• S1000003

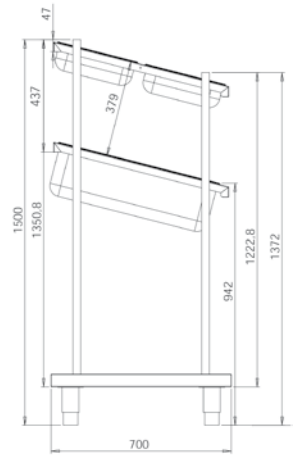

Tray, utensil and bread chute dispenser

- Made of AISI grade 304 stainless steel (18/10).
- High-capacity bread chute.
- Double shelf for trays and glasses.
- Utensil holder made of food-grade PVC.
- Removable tray to collect bread crumbs.

Freestanding

Total dimensions (mm)	Code
800 x 700 x 1520	• S1000001

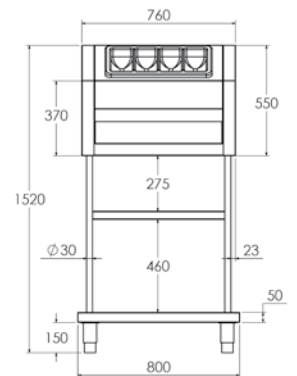

Utensil and bread dispenser

- Made of AISI grade 304 stainless steel (18/10).
- High-capacity bread chute.
- Utensil holder made of food-grade PVC.
- Removable tray to collect bread crumbs.



Countertop

Total dimensions (mm)	Code
760 x 660 x 550	• S1000201

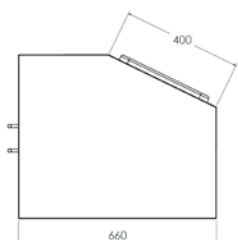
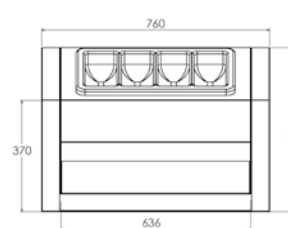

• 6-day shipping

Trolley for glass racks

- Made of AISI grade 304 stainless steel (18/10).
- Ø125 castors, 2 with brakes.
- 5 sets of runners to fit racks of glasses.
- Dish racks not included.
- Measurement of dish racks: 500 x 500 mm.

Total dimensions (mm)

Code

610 x 650 x 1892

• S1000002

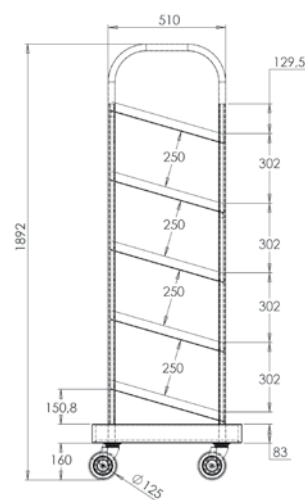

Glass dispenser

- Made of AISI grade 304 stainless steel (18/10).
- Protective bar prevents glasses from falling.
- Stainless steel shelves.

Freestanding (6 shelves)

Total dimensions (mm)

Code

600 x 650 x 1560

• S1100705

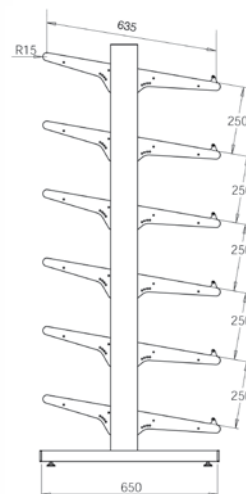

Countertop (3 shelves)

Total dimensions (mm)

Code

600 x 650 x 760

• S1100704

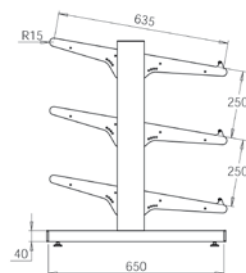

• 6-day shipping

SELF-SERVICE Accessories

Tray slides

- Made of AISI grade 304 stainless steel (18/10).
- Can be adjusted to facilitate alignment.
- Decorative chrome end caps.
- Assembly is required for self-service units.



For self-service units	Total dimensions (mm)	Code
3 GN, 1200 mm neutral and self-service cash register	1200 x 350	• S1020002
1600 mm neutral and 4 GN	1600 x 350	• S1020003
6 GN	2300 x 350	• S1020005
Single-plate 500 mm neutral self-service constant-level plate dispenser	500 x 350	• S1020006
800 mm neutral	800 x 350	• S1020001
Dish rack dispenser	900 x 350	• S1020007
Double-plate constant-level plate dispenser	1000 x 350	• S1020011
Plate dispenser	1300 x 350	• S1020008
Exterior 45° corner	804 x 350	• S1020009
Exterior 90° corner	1490 x 350	• S1020010

Baseboards

For self-service units	Total dimensions (mm)	Code
3 GN, 1200 mm neutral and self-service cash register	1200 x 149	• S1030002
1600 mm neutral and 4 GN	1600 x 149	• S1030003
6 GN	2300 x 149	• S1030005
Single 500 mm neutral and constant-level plate dispenser	500 x 149	• S1030006
800 mm neutral	800 x 149	• S1030001
Dish rack dispenser	900 x 149	• S1030007
Double-plate constant-level plate dispenser	1000 x 149	• S1030014
Plate Dispenser Trolley	1300 x 149	• S1030008
Exterior 90° corner	1018 x 149	• S1030012
Interior 90° corner	570 x 149	• S1030011
Exterior 45° corner	590 x 149	• S1030009
Interior 45° corner	292 x 149	• S1030013
Side baseboard	640 x 149	• S1030015



Pack of castors

- Four Ø150 mm castors (2 with brakes).
- Comes installed in the self-service unit.

Code

- F1020301



Hand rail

- Made of Ø40 mm AISI grade 304 stainless steel (18/10).
- Welded plates with holes for floor installation (screws and anchors included).

Total dimensions (mm)

248 x 1200

Code

- S1020801



• 6-day shipping

Supports with screens

- Screens with light: LED lighting.
- Screens with light and heat: halogen lighting and heating.
- Innovative design.
- High quality finishes.
- Monopiece chassis made in stainless steel of great robustness.
- Easy installation on self-service furniture.
- Easy access to the installation for maintenance.

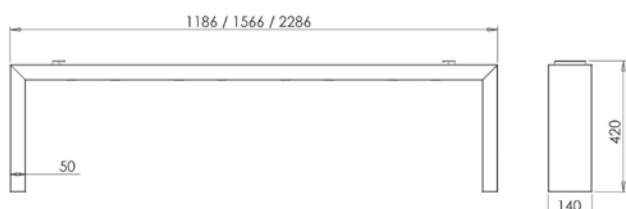

Supports with screens and glass sold separately



Capacity	Neutral Support	LED light Support *	Power (W)	Halogen light and heat Support *	Power (W)
3 GN 1/1	• SJ120901	• SJ120701	12	• SJ120801	600
4 GN 1/1	• SJ120902	• SJ120702	14	• SJ120802	900
6 GN 1/1	• SJ120904	• SJ120704	18	• SJ120804	1200

* Power Supply (V/Hz) 230/50-60

Digital thermometer

- **To display the working temperature of the drop-in.**
- Ideal for one- or two-level ice strips, cold and frozen food tubs, hot food tubs and hot plates.
- Easy to install in any support or screen.

Code

- SLT00001



Glass

- Tempered safety glass to protect food safety.



Two-surface curved glass

Capacity	Totals dimensions (mm)	Code
3 GN 1/1	912 x 550	• FCRC03GN
4 GN 1/1	1242 x 550	• FCRC04GN
6 GN1/1*	912 x 550 (2)	• FCRC06GN

* Two 3GN glasses connected by a central clamp.



Front glass

Capacity	Totals dimensions (mm)	Code
3 GN 1/1	912 x 340	• FCRF03GN
4 GN 1/1	1242 x 340	• FCRF04GN
6 GN 1/1*	912 X 340 (2)	• FCRF06GN

* Two 3GN glasses.

• 6-day shipping

SELF-SERVICE Accessories

Decorative panels

Stainless steel decoration. Personalize your self-service line with decorative panels, available in solid colors or with a wood grain finish. Panels are supplied separately.



Solid finish

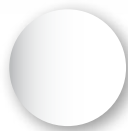

For self-service units	White	Orange	Red	Green
500	• S1010901	• S1020901	• S1030901	• S1040901
800	• S1010902	• S1020902	• S1030902	• S1040902
900	• S1010903	• S1020903	• S1030903	• S1040903
1000	• S1010904	• S1020904	• S1030904	• S1040904
1200	• S1010905	• S1020905	• S1030905	• S1040905
1300	• S1010906	• S1020906	• S1030906	• S1040906
1600	• S1010907	• S1020907	• S1030907	• S1040907
2300	• S1010908	• S1020908	• S1030908	• S1040908
Exterior 90° corner	• S1010909	• S1020909	• S1030909	• S1040909
Interior 90° corner	• S1010910	• S1020910	• S1030910	• S1040910
Exterior 45° corner	• S1010911	• S1020911	• S1030911	• S1040911
Interior 45° corner	• S1010912	• S1020912	• S1030912	• S1040912
Central island kit with food tub and plate	• S1010913	• S1020913	• S1030913	• S1040913
Central island kit with bain-marie	• S1010914	• S1020914	• S1030914	• S1040914

• 6-day shipping



Wood grain finish



For self-service units	Wenge	Canadian Maple	Walnut
500	• S1110911	• S1120911	• S1130911
800	• S1110912	• S1120912	• S1130912
900	• S1110913	• S1120913	• S1130913
1000	• S1110914	• S1120914	• S1130914
1200	• S1110915	• S1120915	• S1130915
1300	• S1110916	• S1120916	• S1130916
1600	• S1110917	• S1120917	• S1130917
2300	• S1110918	• S1120918	• S1130918
Exterior 90° corner	• S1110919	• S1120919	• S1130919
Interior 90° corner	• S1110920	• S1120920	• S1130920
Exterior 45° corner	• S1110921	• S1120921	• S1130921
Interior 45° corner	• S1110922	• S1120922	• S1130922
Central island kit with food tub and plate	• S1110923	• S1120923	• S1130923
Central island kit with bain-marie	• S1110924	• S1120924	• S1130924

• 6-day shipping



SALES, TERMS AND CONDITIONS

CONDITIONS OF SALE

PRICING

The prices listed in this catalogue are in Euros and do not include any taxes that may apply by law. Prices listed do not include transport, installation or accessories.

METHODS OF PAYMENT

Below are the general payment terms, in addition to any other terms and conditions that may be agreed upon between the customer and DISTFORM, S.L.:

- Until credit insurance for the customer is confirmed by the insurance company, all transactions must be paid in advance. Once the insurance company confirms a credit risk insurance, payment terms is 30 D bank transfer. Any special condition or exception has to be confirmed by DISTFORM SL.
- A penalty fee of 25% of the total unpaid amount will apply in the case of overdue payments.

All products are the property of DISTFORM, S.L. until payment is completely done.

ORDERS

Customers may use any of the following methods for placing orders:

Email: comercial@distform.com

Fax, along with a copy of your order and your method of payment, to:

+34 973 751 501

- Any modification to the original price estimate is subject to acceptance by both parties, regardless of the original order.
- The color-coded shipping periods listed herein (24 hours, 3 days, 6 days, and 12 days) are considered the standard shipping time for that particular product, with the exception of occasional delays and/or manufacturing issues. These periods are non-binding and thus are not a valid reason for canceling or filing a claim on an order.
- Order cancellations must be received in writing and accepted by Distform. Orders shall be accepted based on the conditions of sale set forth by Distform, S.L.
- Full or partial cancelation of an order shall not be valid if the product has already left the Distform warehouse.
- Orders may not be canceled for products that have been especially produced in any way for the customer.
- Distform reserves the right to modify prices and substitute materials in this catalogue for others of similar quality and features, without prior notice.

TRANSPORTATION

Delivery terms are EXW Distform, 25123 Torrefarrera/Spain.

Special packaging or shipping options may be only done at customer's expense. (The mentioned shipping times, marked with the different colours, mean the production times. This is, when the product is ready for pick-up. Does not include transport nor transit times.)

DELIVERY ACCEPTANCE

In case of any special delivery agreement, and if the customer does not notify Distform immediately of any possible problem or defect at the time of delivery reception, the customer shall have 24 hours to notify us directly by sending a copy of the document to Distform.

If the above mentioned 24 hour time frame is not met, the customer waives any right to file a claim for the merchandise. The transportation company shall not be responsible for claims filed outside of the established 24 hour time period.

RETURNS

Returns will not be accepted without prior express written consent from Distform. Our warehouse will automatically reject any unauthorized returns.

Only products with 24-hour shipping periods will be accepted for returns.

Returns may only be accepted if unused, in perfect condition, and in their original packaging. Returns must be made within 30 days of invoicing.

In the event that Distform must reimburse a sum against a previous order's invoice, the amount will be determined based on the condition of the materials returned. In all such cases, Distform will discount at least 20% of the refund total as an administrative fee. Shipping and handling will always be billed to the Customer.

RESERVATION OF TITLE

All merchandise is the property of Distform until the Customer has paid for it in full. In the event that the Customer does not pay on time, Distform may reclaim the merchandise in question, reserving the right to claim any damages that may have resulted from said non-payment. Expenses incurred when reclaiming unpaid merchandise shall be billed to the Customer.

WARRANTY

Legal warranty: Based on the provisions of Royal Legislative Decree 1/2007 (Spain), all products sold by DISTFORM S.L. shall include a legal warranty lasting for one year for all new products. The warranty does not cover issues caused by negligence, dents, improper use or handling, undue stress on the item, poor installation, or materials subject to normal wear and tear.

Manufacturer's warranty: All products sold by DISTFORM, S.L. include an official manufacturer's warranty, which covers manufacturing defects and any breakage occurring during the warranty period. If DISTFORM S.L. handles the repair of your product at an authorized Distform repair shop, the cost of shipping the product to our returns center shall be at the expense of DISTFORM, S.L. (unless the repair is related to a possible error in original acceptance).

The warranty shall not apply in the following cases:

- Damage caused by modification or adjustment (aside from regular use) or modifications made to a product without the manufacturer's express consent.
- Any periodic maintenance, repairs, or exchange of parts due to normal wear and tear. Replacement of consumable parts (such as batteries, light bulbs, fuses, glass, or supply cords).
- Damage caused by improper use of the product or resulting from not following the manufacturer's instructions regarding the use, maintenance, and proper installation of the product. This includes changes to the color, oxidation, or corrosion of the appliance or any element thereof.
- Damages caused by unauthorized persons or the users themselves.
- Damages caused by accident, lightning, flood, fire, poor ventilation, or any other force majeure event.
- If the model or serial number indicated on the product has been altered.
- Products that have been repaired previously by service technicians not recognized by DISTFORM S.L.

Labor fees shall be at the Customer's expense. The warranty shall cover materials, but compensation shall not be offered under any circumstances.

Replacement materials shall be transported at the Customer's expense and risk.

CONDITIONS OF SALE

INTELLECTUAL PROPERTY

According to current intellectual and industrial property law, this catalogue and any material, brand, design, model, logo, or graphic contained herein shall be the exclusive property of Distform, S.L. or its affiliates, which does not grant any right or license to the use thereof other than consulting the Catalogue. Reproduction or use of these materials in whole or in part is authorized only for personal and private use. Any reproduction or use of copies for other purposes is expressly prohibited. Any improper use of same shall constitute fraud and shall be punishable by law unless prior written authorization was granted by DISTFORM S.L.

DISTFORM S.L. shall not be liable for any error or omission in any of the photographs, prices, text or images, information, or features of the products, nor shall it be liable for any modifications its suppliers may make to the products.

LEGAL RESPONSIBILITIES

DISTFORM S.L. shall not be liable for non-compliance with these terms and conditions in the case of a force majeure event or non-compliance by the customer or an unforeseen action of a third party.

DISTFORM S.L. shall not be liable for the consequences of misuse of its products.

Disputes shall be subject to arbitration by the Consumer Arbitration Board and/or Advertising Board. If the decision made by the arbitration board is not accepted by one or both parties, the matter will be taken to the Courts and Tribunals in the city of Lleida, Spain.

distform
foodservice solutions

www.distform.com

info@distform.com / +34 973 751 348

Factory & Headquarters

C. Tramontana at the corner of C. Migjorn
25123 Torrefarrera, Lleida (Spain)

International Department

Rbla. Catalunya 125, 1º 2ª A
08008 Barcelona (Spain)