

Big Dream  
2019



**ascaso**  
BARCELONA



# 120 YEARS AGO

The first espresso coffee machine was manufactured more than **120 years** ago. Since then, the materials used to manufacture coffee machines have barely changed.

Yes, 120 years...

**120 years** in which there has been a huge evolution in terms of the design, exterior materials and electronic devices that facilitate and improve coffee extraction... Yet inside, at the **heart of the machine, nothing has happened for over a century**. Brass and copper are still the main components of coffee machines. The technical characteristics of these materials tell us that thermal stability, energy efficiency, mechanical resistance and lime scale adherence to the components cannot possibly be optimal.

So... why not seek out the best?

At our factory in Barcelona, we have engineered change: more than a century later, we have **manufactured the first coffee machine that eschews the conventional materials of the previous century, replacing them completely with stainless steel**. The beautiful Big Dream is the result of years of development and the enthusiasm of a team of engineers with the ambition to change one hundred years of history.

The first coffee machine in the world in which 100% of the components are made from stainless steel.



**Saturated group**  
100% stainless steel AISI 316L

**ascaso**  
BARCELONA



# WHY STAINLESS STEEL?

Brass and copper have been used (and still are) as main materials in coffee machines components for over 100 years.

Technical characteristics of these materials show us that thermal stability, energy efficiency, mechanical resistance and scale deposit formation in the components are not optimal.

Is there any material which dramatically improves the **copper and brass properties?**

Is there any **energy-efficient, thermally stable, anti-scale**, with high mechanic resistance and **100% healthy material?**

Is there any possibility of a **pure coffee**, without presence of **heavy metals** altering its taste?

There is indeed! And it's called

## Stainless Steel

The most efficient, enduring and compelling product in the metallurgy.



**Steam/water boiler**  
100% stainless steel AISI 316L

# We love stainless steel!

It is used in surgical instruments, containers for the food industry, the pharmaceutical industry, the aeronautical sector, drinking water pipes and... from now on, to manufacture espresso coffee machines.

With this new structural language (and a great deal of enthusiasm) we have managed to create a unique and optimal product. The definitive response to all the challenges we posed to our engineers.



## **Long Life: Created to last.**

Stainless steel has enabled us to create a long-lasting product which is therefore more sustainable. The mechanical resistance of this material ensures our coffee machines have a longer useful life.

It is resistant to corrosion, to temperatures of up to 300°C, to water, to steam and to humidity. Furthermore, stainless steel is immune to lime scale which is the cause of 70% of repairs to professional coffee machines.



## **Energy-efficient.**

Stainless steel, meanwhile, is a very bad heat conductor and thus an extremely bad dissipater. Therefore, it is a material that requires less power to maintain thermal stability. As well as using this material, our engineering department also introduced additional measures to achieve energy savings of 40% compared to a traditional machine made from copper and brass.



## **100% coffee. 100% healthy.**

**With stainless steel internal components there is no migration of heavy metals to the coffee infusion**, which is the case with machines that use copper and brass. The espresso shot with which we create the end result is 100% pure coffee, with no infiltration of other elements that might alter its flavour, aroma or texture. There is no nickel, no lead, no cadmium...



## **High Technology.**

Big Dream is a product that incorporates the industry's latest technology, in regard to both hardware and software.

The use of stainless steel in all its internal components (whether water flows through them or not), in itself makes this a 'next generation' machine. But it also has multiple other new features.



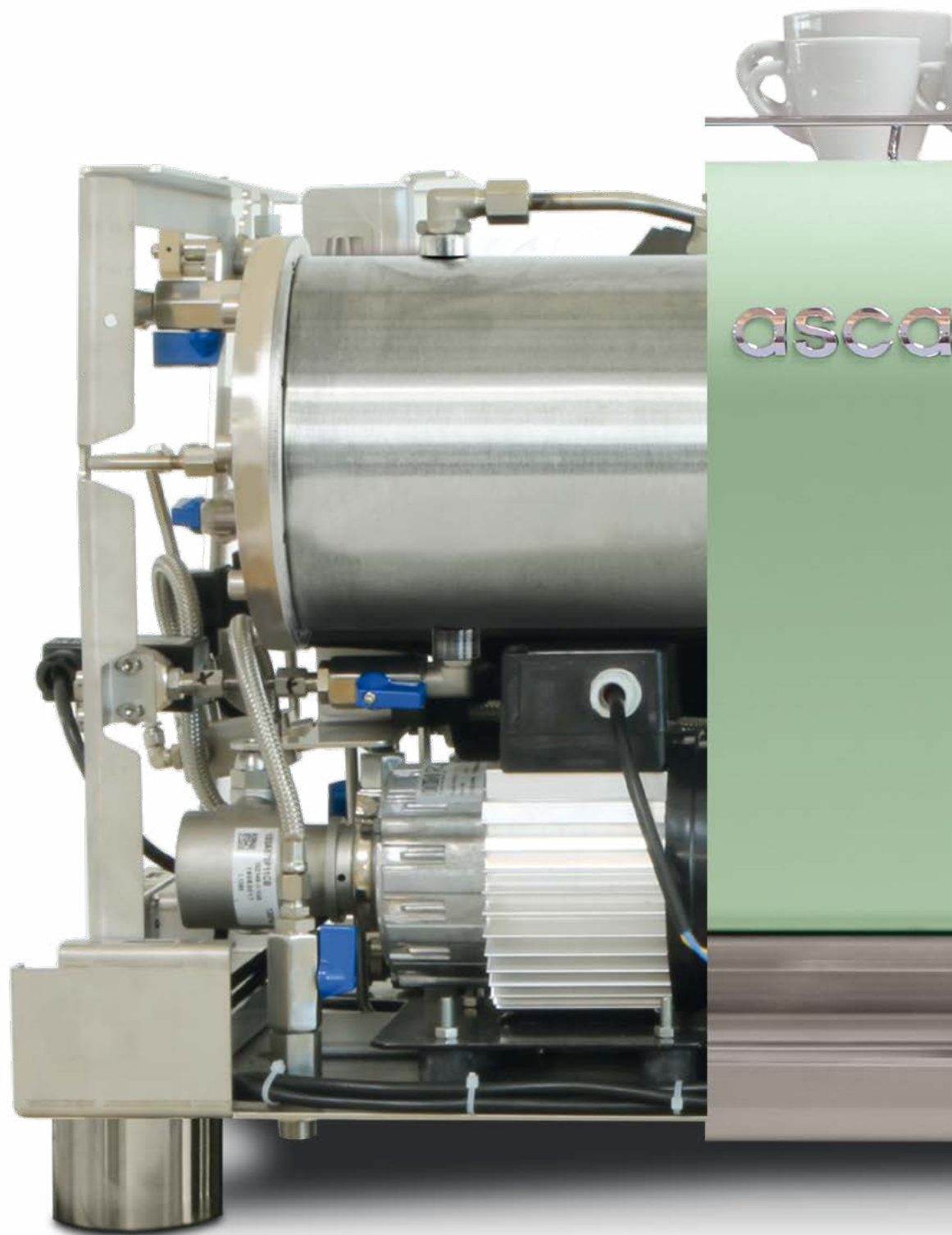

**The first and only espresso machine in the**



**world built entirely of stainless steel internals.**

# MODELS

## Big Dream Specialty

The **Specialty** series is our top-of-the-range product.

It features everything that the most discerning barista might require from a top-level coffee machine. **All its components are in stainless steel**, it boasts exceptional thermal stability, double pre-infusion system and unique details. The maximum efficiency for an extraordinary cup of coffee.

## Big Dream Plus

The **Plus** series is a truly superlative coffee machine.

With a few external differences from its big sister and a few more internal ones, this machines perfectly meets the needs of the professional barista as well as less expert users.

**All its components are in stainless steel.**





ascaso  
BARCELONA



Big Dream 2GR White



Big Dream 3GR White



Big Dream 2GR Cream



Big Dream 3GR Cream



Big Dream 2GR Green



Big Dream 3GR Green



Big Dream 2GR Blue



Big Dream 3GR Blue

# MAIN FEATURES



Big Dream 2GR Black



Big Dream 3GR Black

- **Manufactured completely in stainless steel.** All components are stainless steel, replacing the copper and brass of traditional machines.
- 304 Stainless steel frame and 2.5 mm thick.
- Multigroup.
- Multiboiler Technology / Saturated groups.
- Independent steam boiler. Extremely sturdy. Large capacity.
- Insulated boilers (coffee and steam) & groups.
- PID control (+ 0,1°) for each group and steam boiler.
- Touch Digital Display & Software. Functional and intuitive.
- Independent displays Temperature/Timer for each group.
- Thermal stability (+- 0,2°). (+-0,4° Big Dream One y Big Dream Plus)
- Dynamic pre-heating.
- Energy efficiency (40%).
- Two options of pre-infusion
- Hot water. Double selection (volume).
- Precise water temperature control for infusions.
- Powerful steam (pipe 12 mm).
- High performance volumetric pump. Constant pressure even after a prolonged and simultaneous use of more groups.
- High precision filters in AISI 304 stainless steel. High quality in cup.
- Adjustable cupwarmer. From 30 to 60°C.
- Designed for Baristas: Low profile (49 cm height), shot mirror, joy-stick steam wands: two position, LED Working area, LEDS RGB Keypad, 5 selections, autoflush.
- Colors & Custom.
- Emptying/filling boilers, fully automatic or manual.
- Wood accesories (by model)





ascaso

93.6 00.0

13:17 Mo, 20 May	Menu	⏻
96.9° 1	95.8° 2	122.6° Temp Control

- ☕
- ☕
- ☕
- ☕
- ☕





# DESIGN

## Stainless steel bodywork and base

**The body** is made entirely from 304 grade stainless steel. At 2.5 mm thick, we have created a coffee machine for life.



## Baydur body

The body is manufactured from a combination of high-gloss 304 grade stainless steel in areas in contact with water and Baydur® for the outer shell. This is a modern material that combines freedom of design and practicality: excellent mechanical resistance, resistant to high temperatures and a watertight interior.



## Backlit button pad and high-precision pressure gauges

High-tech, top quality button pad. **Button pads in AISI 316 stainless steel** with a high-gloss finish and RGB LEDs for a choice of up to 256 colours.

With five programmed volume selections. 'Volume' refers to the option of setting the quantity of water in each coffee.

**High-precision pressure gauges.** Casing in AISI 304 stainless steel.



**ascaso**  
BARCELONA

# Colours

Colour is more than just a shade. It expresses feelings, reveals personality and communicates with others.

We wanted our Big Dream to follow in the footsteps of its predecessor: colour, colour and more colour! A colourful statement of intent.

Colour is its DNA... which is your favourite?



# DESIGN

## Steam wands

Made from 'cool touch' AISI 316L stainless steel. Very thick (12 mm in diameter). The heat insulation (double stainless steel wall + insulating material) prevents burns and makes it easy to clean any milk residue.

We offer two types of outlet:

- Outlet with four holes 1.2 mm in diameter, with a smaller steam flow for greater control.
- Outlet with four holes 1.6 mm in diameter with a larger steam flow for heating large quantities of milk.

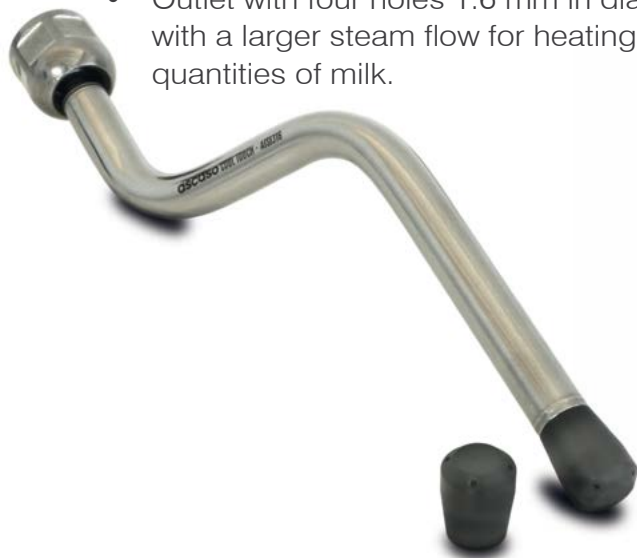

## Wooden filter holder handle

Ergonomic filter holder: the filter holder is one of the most heavily used parts of the machine. It is important that the design facilitates the barista's work. The 10° tilt facilitates its use, allowing the hand to adopt a natural position.

We use olive wood (*Olea europaea*) as standard but can also customize the handle with oak or walnut.



## Thin wire tray

Designed to keep the bottoms of the cups clean.

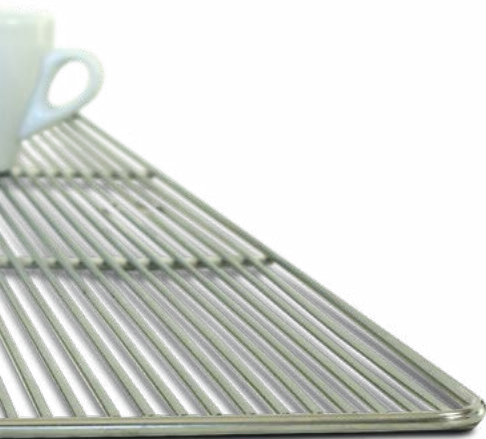

## Rail and cup warmer

Rail: Solid and attractive in high-gloss stainless steel.

Spacious adjustable cup warmer (30°C to 60°C) in AISI 304 stainless steel.

On/off option. Keeps espresso and cappuccino cups at the perfect temperature for a delicious cup of coffee.





# DESIGN

## Steam joystick

Its ergonomic design has been tested by professional baristas.

The stick facilitates use and improves control. A smooth, intuitive 'natural' movement makes it easy to use and control.

When the barista activates the cam, he can adjust the amount of steam in proportion to the level of force exerted. It can also be left completely open.



## Customization

**(only if you want, because it's already so, so beautiful...)**

We offer the full range of RAL colours (256 in total), accessorized by different fine woods for the filter holder and steam joystick, and we also welcome special requests (personalized logos, printing, stencils, etc.). Just tell us what you need, but first of all take a look at our standard colours and finishes.



## LED lighting

LEDS in the work area. These give the barista a better view of the cup and enhance the visibility of the machine on the bar to showcase its spectacular design.

It is essential that the work area is properly lit.

Button panel LEDs. We use state-of-the-art RGB LEDs which offer a choice of up to 256 colours.



# TECHNOLOGY

## Saturated coffee groups

AISI 316L stainless steel

The heart of the machine.

Manufactured in **100% AISI 316L** stainless steel. Welded with plasma, both inside and out, to avoid any cracks that might cause corrosion. The design and material of the coffee groups provide:

- Energy efficiency.
- Thermal stability.
- Mechanical resistance.
- Anti-lime scale effect.
- Nickel- and lead-free coffee .
- Improved results in the cup.
- Easy cleaning: there is an upper lid which lets you inspect the interior condition of each group.
- Our saturated coffee groups are exceptional. The heaviest on the market.



The coffee group is completely 'enveloped' by thermal cladding. Unique in the market. Thermal stability. Energy efficiency.

## Multi-Boiler System

The multi-boiler technology is based on coffee groups and a steam boiler that work completely independently. Each group and boiler have their own autonomous heating system, safety device and precise electronic temperature control.

This system is much more evolved than the conventional system of a single boiler or the dual boiler machines.

### Advantages:

Aids energy saving

1. You can turn a group on or off **independently**.

2. **Standby** function by group or for all the groups. Being independent, the power is only used for the parts of the machine you are using at that particular time.



# TECHNOLOGY

## Independent steam boiler

AISI 316L stainless steel



Manufactured in **100% AISI 316L** stainless steel.

Plasma-welded both inside and out.

**Extremely sturdy:** Boiler thickness: 2.5 mm /

**Lid thickness:** 10 mm

**Large capacity:** 8/12 litres

**Weight:** 9 kg

Every Big Dream has a boiler dedicated exclusively to producing steam; its large capacity produces a dry steam that facilitates the preparation of cappuccinos, lattes and macchiatos with **exceptional power**.

In addition, with more than **9 kg of thermal mass** in very thick AISI 316L stainless steel it provides exceptional thermal stability. This means that the steam pressure is kept constant and it uses less energy while at the same time maximising steam production.



Lime scale hardly ever adheres to stainless steel. This makes cleaning much simpler and means repairs are a thing of the past.

Our boilers (coffee and steam) include a **thermal sleeve** which reduces the machine's consumption by up to 35%.

- Excellent **thermal stability**.
- **Excellent extraction quality** for either small or large operating volumes. The quantity of steam does not influence the thermal stability of the coffee groups.
- High, consistent steam production (**exclusive boiler**).
- The machine **can be adjusted** to different types of coffees and roasts.
- **Extra safety level**. If there is a problem with one group, the others will continue working.
- **Easy to repair**.

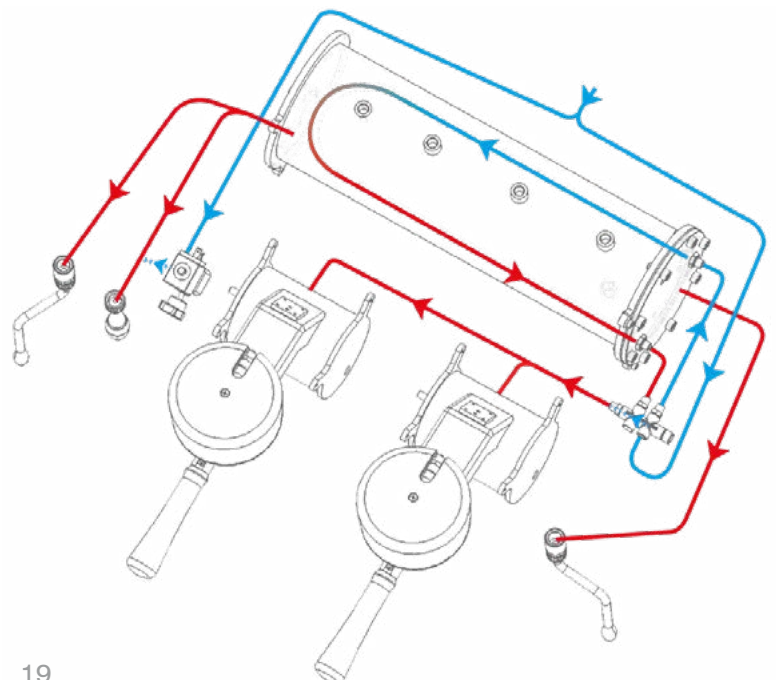

# TECHNOLOGY

## PID Control Triple Temperature Control

(PID) (Proportional Integral Derivative)  
Easy and optimal temperature regulation lets you select the appropriate extraction process for each coffee, producing excellent results.

Our system offers a precision of  $0.2^{\circ}\text{C}$  which considerably reduces any heat fluctuations within the coffee group. The barista simply has to select the desired temperature and Big Dream will do the rest.

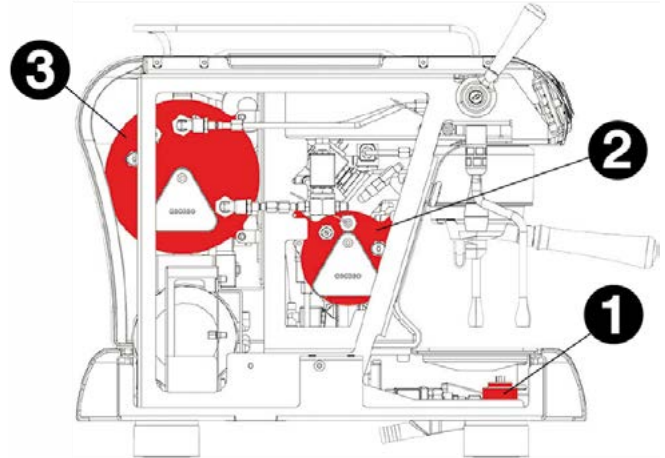

To do so, Big Dream has triple temperature control:

**1. Dynamic pre-heating/temperature control of the water entering the coffee group** through the mixer valve. The water that supplies the coffee group will enter pre-heated to the required temperature.

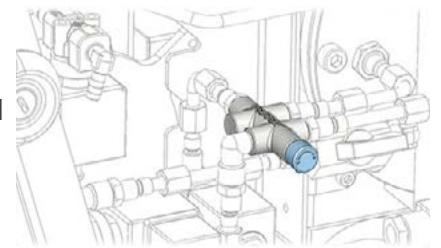

**2. Control of the temperature of each coffee group (PID).**

Each group is completely independent and easy to control by the general or individual display (precision of  $0.1^{\circ}\text{C}$ ).

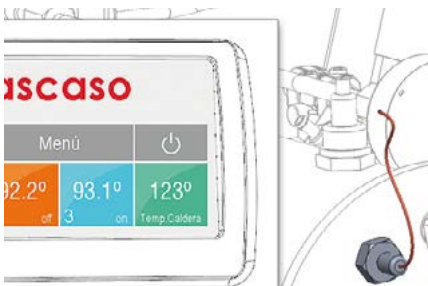

The temperature of each group is controlled by an NTC sensor. The high-speed heat sensor replaces the traditional mechanical thermostat. These high-precision sensors are immersed in the water of each distribution group. The sensors activate the element by means of a static relay (solid state relay). They improve thermal stability, eliminate mechanical failure, and significantly reduce heat fluctuations in each coffee group.

**3. Control of the steam boiler/water temperature (PID).**

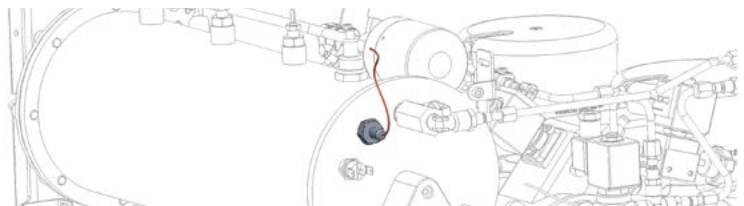

# TECHNOLOGY

## Double pre-infusion

The main objective of the pre-infusion is to fully and evenly moisten the coffee tablet before the extraction phase, improving its flavour. The aim is to produce a cup of coffee with more nuances, flavours and aromas, and to adapt the coffee machine to the numerous different sources and types of coffee roast.

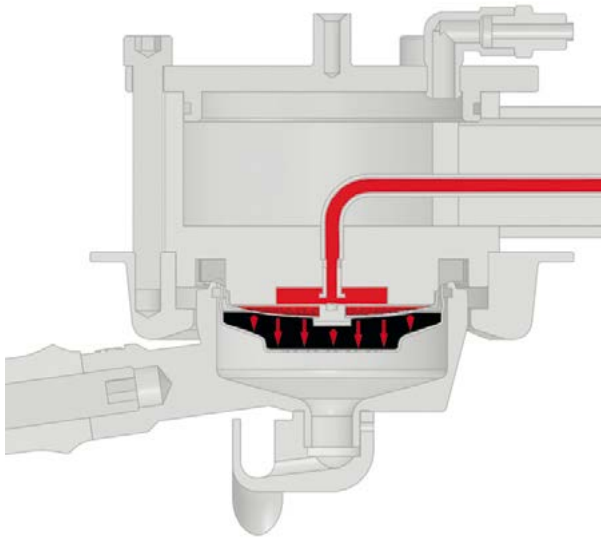

In machines with very precise temperature control you need a good pre-infusion system that lets you extract the full gamut of complexities from the coffee.

## Pre-infusion

The idea is not just to moisten the puck. Soft pre-infusion makes the pre-infusion process an integral part of the extraction.

Yet by changing the pre-infusion time, the grind point (this pre-infusion allows a finer grind), the quantity of coffee, etc., you can obtain other 'pre-infusion profiles'.

A soft pre-infusion lets you extract new flavours and aromas from your coffee. It also lets you use finer graduations when grinding. In addition, a lower-pressure impact on the dry puck also helps to avoid channelling.

### There are two pre-infusion options:

#### Classic and Soft

This lets you achieve double 'flavour profiling'. Completely programmable in each group and each dose selection independently and easily by using the display. With both the pre-infusions you can guarantee that the entire coffee puck will be moistened to the full depth of the filter.

#### Classic or flat pre-infusion

Pre-infusion at 9 bar (or the pressure regulated in the pump), and infusion at 9 bar. Both at the same pressure. With two controllable times: the pre-infusion time and the waiting time until infusion starts. This is a system that most machines on the market offer, with excellent results.

#### Soft pre-infusion

The pre-infusion is done directly at the pressure of the group, without any pump action. A progressive pre-infusion at 0-3 bar takes place. The infusion is done at 9 bar (or the pressure regulated in the pump). With three independent and controllable times in each group: the pre-infusion time and the waiting time until starting the infusion.

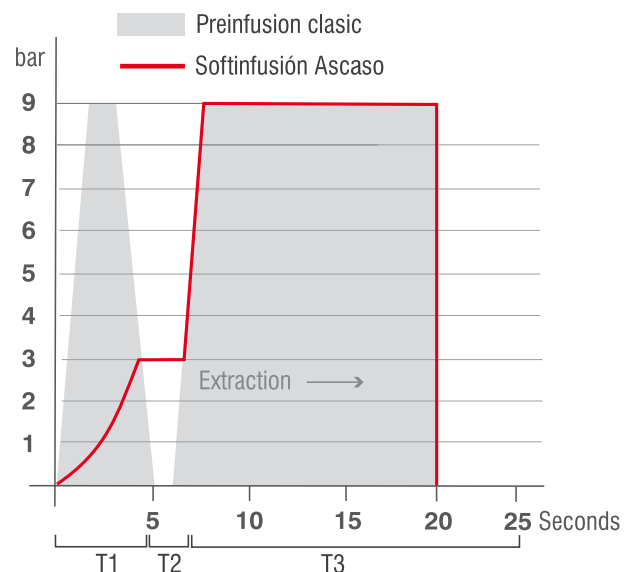

3 easy adjustable control times.

T1: Pre-infusion (1 to 30 seconds)

T2: Stopping before infusion (1 to 30 seconds)

T3: Infusion (Unlimited)

# TECHNOLOGY

## Electrical components

- **Heating elements** in Incoloy 800 stainless steel. Much higher quality than traditional copper ones. Withstands high temperatures and minimizes the possibility of overheating or failures if the machine runs out of water. Excellent resistance to corrosion and rusting in aqueous environments. Its structure remains stable during prolonged exposure to high temperatures). 100% food safe. Anti-lime scale material. The cover of the element (platen) is also made from AISI 316 stainless steel.
- **Solenoid valves** in AISI 316 stainless steel.
- **Internal motor** for continuous use (24 h). Manufactured by RPM. High power 245W. (2-3 groups).
- **Rotary pump** in AISI 316 stainless steel. Procon 200 l.
- **Flow meters**. State-of-the-art. More precise.
- Top-quality **static relays** used in all electrical circuits.
- **High-quality safety thermostats** in the coffee groups and steam boiler.
- **NTC temperature sensors** in stainless steel in the coffee groups and steam boiler.
- **Heat-protected general wiring**. Maximum protection and quality. 100% silicone wide section wiring. All wiring is sheathed in a silicone + glass fibre heat protection jacket (250°C maximum resistance).



## Valves/Tubes/Couplings

All in AISI 316 stainless steel

- **Vacuum valve** in AISI 316 stainless steel. New technology. The most reliable on the market.
- **Expansion valve** in AISI 316 stainless steel.
- **Retention valve** in AISI 316 stainless steel.
- **Couplings** throughout the machine are AISI 316 stainless steel
- **Tubes** throughout the machine are AISI 316 stainless steel.
- **Internal valves** in AISI 316 stainless steel to facilitate the repair of the different components without having to switch off the machine.



AISI 316L  
Stainless steel

ascaso  
BARCELONA



# TECHNOLOGY



## Filter holder/Filters/Seal rings

The filter holder is one of the most heavily used parts of the machine. It is important that the design facilitates the barista's work.

We focused on various aspects of the handle:

- Filter holder in AISI 316 stainless steel.
- Designed to adapt to the palm of the hand, conveying a pleasant sense of strength and safety in use.
- Horizontal resting position of the filter holder for perfect tamping of the ground coffee.
- The filter holder body has a flat base to facilitate optimum tamping.

**Soft filter holder closing action:** The precision-design of the group head and the conical design of the seal ring provide a smooth, streamlined and uniform feeling when coupling the filter holder to the group.

**Coffee spouts** in AISI 316 stainless steel. Thanks to the closing system these are always positioned centrally, making assembly and dismantling safe and easy.

## HNBR seal ring

Material: HNBR. Hydrogenated. Can withstand temperatures of up to 160°. Our tests show that they have double the normal lifespan of standard high-quality rubber seal rings. Food safe material. In green.

Design: Specially designed rubber seal rings. Thick and flexible. The side grooves release air and water, making installation easier. The conical shape allows a smoother closing action than a traditional flat joint.



## Competition filters

in AISI 304 stainless steel. These are essential for optimum extraction. We only use high-precision filters. Only a top quality, cutting-edge production process can guarantee a consistent result. Filter by filter. Hole by hole. Otherwise, there would be significant differences in the cups and systematic extraction variations (over/under).



- 1 mm thick AISI 304 stainless steel plate. The usual thickness is 0.6 mm.
- Laser engraving, including a different serial number for each filter.
- High-tech manufacturing.



ascaso  
BARCELONA



# TECHNOLOGY

## Capacitive display

**High definition backlit capacitive display.** 4.2" LCD screen. Allows total control of all the machine's parameters in an instant, quickly and intuitively.

The display gives real time feedback on all the operations the machine is performing at any given time (with three access levels: barista, technician and factory). There are several simple, fast and intuitive menus. It's like using a smartphone! The icon language is instantly familiar.

This is a state-of-the-art product (touchscreen, highly sensitive, icons with sounds, video display, dual wallpaper option – black or white – tempered glass, anti-knock and anti-scratch surface, etc.).

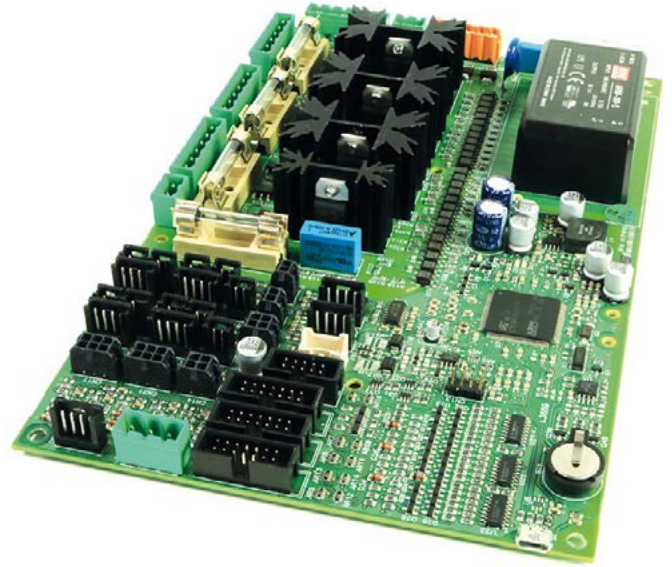

## State-of the-art switchboard

Every machine comes with an Integrated Digital Control System (switchboard). This system guarantees the utmost precision in the digital programming and regulation of all the machine's parameters. It is the machine's 'brain'. We have developed totally new, state-of-the-art software, offering total control over the machine through the display. It features all kinds of functionalities, alerts and records and is unique in its field.

## Double display per group



### Display 1

- Independent electronic temperature control for the coffee group (PID). On/Off per group.
- Independent electronic temperature control for the steam boiler (PID). Independent On/Off.
- Counter (number of coffees, total and partial).
- Programmable pre-infusion (0 to 5 seconds). Precision 0,1 seconds. All selections adjustables.
- Pid parameters control (only technicians).
- Multiple Alarms display.

### Display 2

Coffee dose timer.

# TECHNOLOGY

## Energy-efficient

Stainless steel, meanwhile, is a very bad heat conductor and thus an extremely bad dissipater. Therefore, it is a material that requires less power to maintain thermal stability. This characteristic of stainless steel results in improved energy efficiency. By maintaining the optimum operating temperature, the machine requires less electrical power.

As well as using this material, our engineering department also introduced additional measures to achieve energy savings of 40% compared to a traditional machine made from copper and brass.

Additional measures:

- **Electronic temperature management.** Computer software and high-precision sensors that manage the system automatically. Programmable standby and On/Off functions.
- **PID Control** in all the coffee boilers and the steam boiler. All the boilers are controlled by a PID system, featuring electronic thermostats that are much more precise and act much faster than the traditional mechanical pressure gauge system.

- **The Multi-Boiler System** means that power is only used by the part of the machine in use at any time. Each group can be turned off or on independently.
- **Thermal lagging** made from high-tech material for coffee and steam boilers. Thermal lagging notably increases the quality of the coffee machine.



We guarantee a saving 40% compared to a single boiler traditional coffee machine.

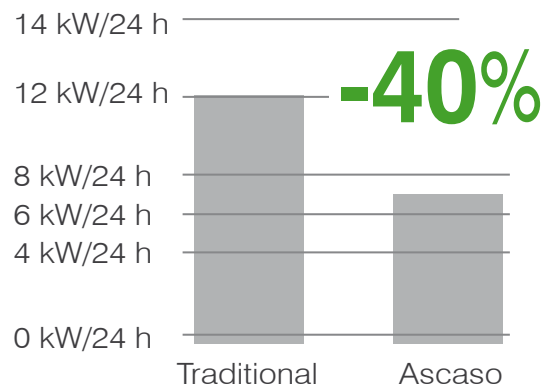

# ERGONOMICS

## Keeping baristas happy

In the espresso world, when we talk about ergonomics we mean the optimization of the design of the coffee machine so the professional barista can work in the utmost comfort. Basically, what we are looking for is that the barista can perform his 'choreography' smoothly, comfortably and happily.

Based on structured data collection, we have designed our machine in line with the different ergonomic parameters demanded by baristas to ensure that their relationship with the Big Dream is a joyous one. The essential elements have been devised and designed so that the creation of an espresso coffee and its specific choreography take place in the most comfortable possible circumstances for the professional barista.



**ascaso**  
BARCELONA



# ERGONOMICS

## Keeping technicians happy

The machine has been designed primarily from the point of view of the barista, but we also took the technician's perspective very much into account.

This is a nice product to repair! It is easy to dismantle with standard tools. It has very few screws and the components are easily accessible. There is plenty of space to carry out repairs with complete assurance.

Good design presupposes that the product can be dismantled and repaired with ease. The idea is that it will last for years and years.

It is a matter of quality, productivity and also sustainability.

We have worked on this component by component.

- **Easy access.** By just taking out a few screws you have access to all the components: Solenoid valves, heating elements... everything inside the machine.
- **Internal valves.** We have installed valves to facilitate the machine's repair either on site or in a workshop.
- **Steam wands.** Very easy to dismantle. Easy to clean.
- **External pump regulation.** Easy access.
- **A special tube locking system in 316 grade stainless steel.** We have created a new locking system by eliminating copper and brass. This system allows it to be assembled and dismantled with no risk of loss and with almost no effort.
- **Electrical and electronic components protected and insulated** from heat sources (boilers). Independent, unified electronic section. Easy access for repairs. The use of insulating material for boilers guarantees a 'cool' interior temperature and lengthens the lifespan of all the components, avoiding the need for repairs.

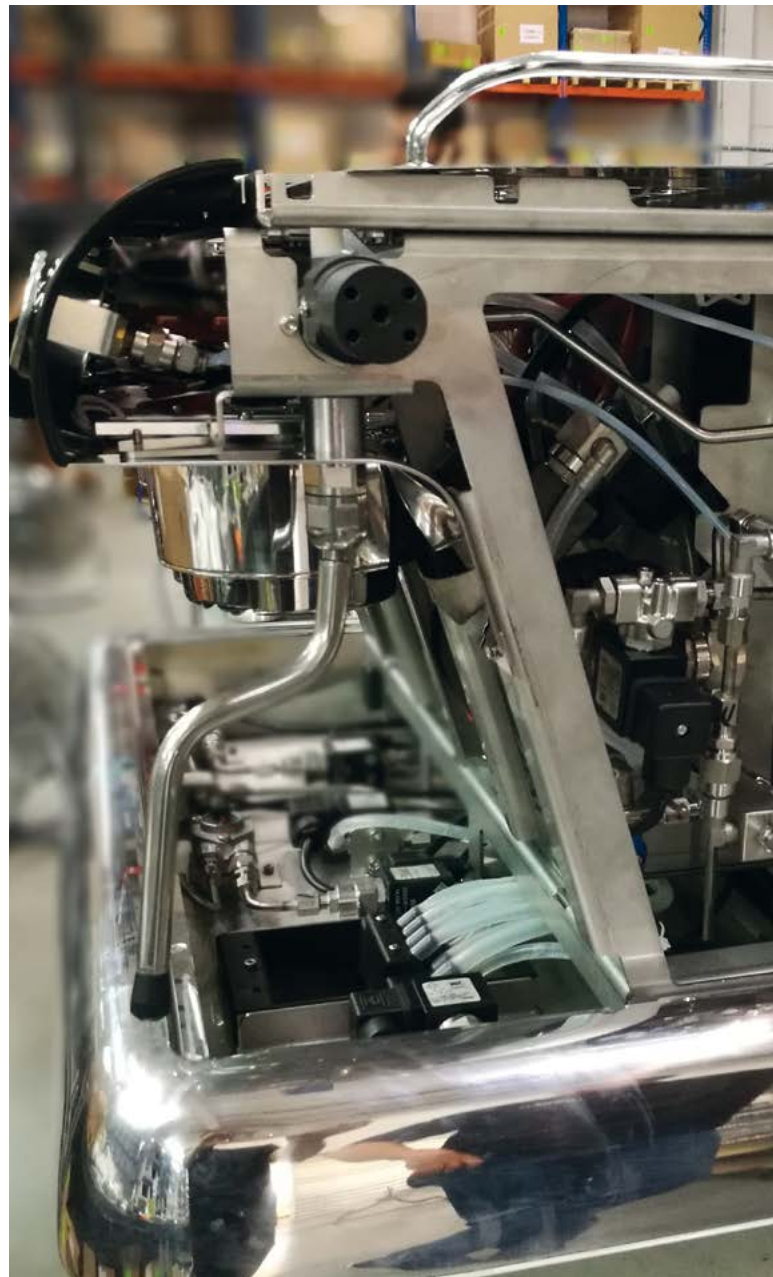



ascaso

10:31

Mi, 4 Oct

Menü

94.9°

1 on

94.6°

2 on

3 on



# TECHNICAL DATA

Model	Big Dream Specialty		Big Dream Plus	
	2 GR	3 GR	2 GR	3 GR
w/wBase dimensions	930/860 mm	1.189/1.121 mm	930/860 mm	1.189/1.121 mm
h/d dimensions	554/593 mm	554/593 mm	554/593 mm	554/593 mm
Boiler power supply (230 V)	3500 W	4500 W	3500 W	4500 W
Coffee group power supply (230 V)	800 W	800 W	800 W	800 W
Cup warmer power supply (230 V)	100 W	125 W	100 W	125 W
Total power consumption (230 V)	5445 W (25 A)	7270 W (33 A)	5445 W (25 A)	7270 W (33 A)
Motor power	245 W	245 W	245 W	245 W
Boiler capacity	8 l	12 l	8 l	12 l
Coffee group capacity	1,3 l. x2	1,3 l. x3	1,3 l. x2	1,3 l. x3
PID control (coffee-steam) Multiboiler	●			●
Digital Multifunction Display(Touch screen)	●			●
Double dose hot water	●			●
Water temperature control (external)	●			●
100% stainless steel	●			●
Thermal cladding in coffee and steam boilers	●			●
Adjustable cup warmer	●			●
Dynamic pre-heating	●			
Double pre-infusion system	●			
Boiler emptying	Automatic		Manual	
Wooden handles	Olive		Walnut	
Steam nozzle	Double stainless steel wall (Ø12mm)		Teflon tube (Ø10mm)	
Coffee tamper	Olive wood + stainless steel		Aluminium	
External box	Wood		Wood	

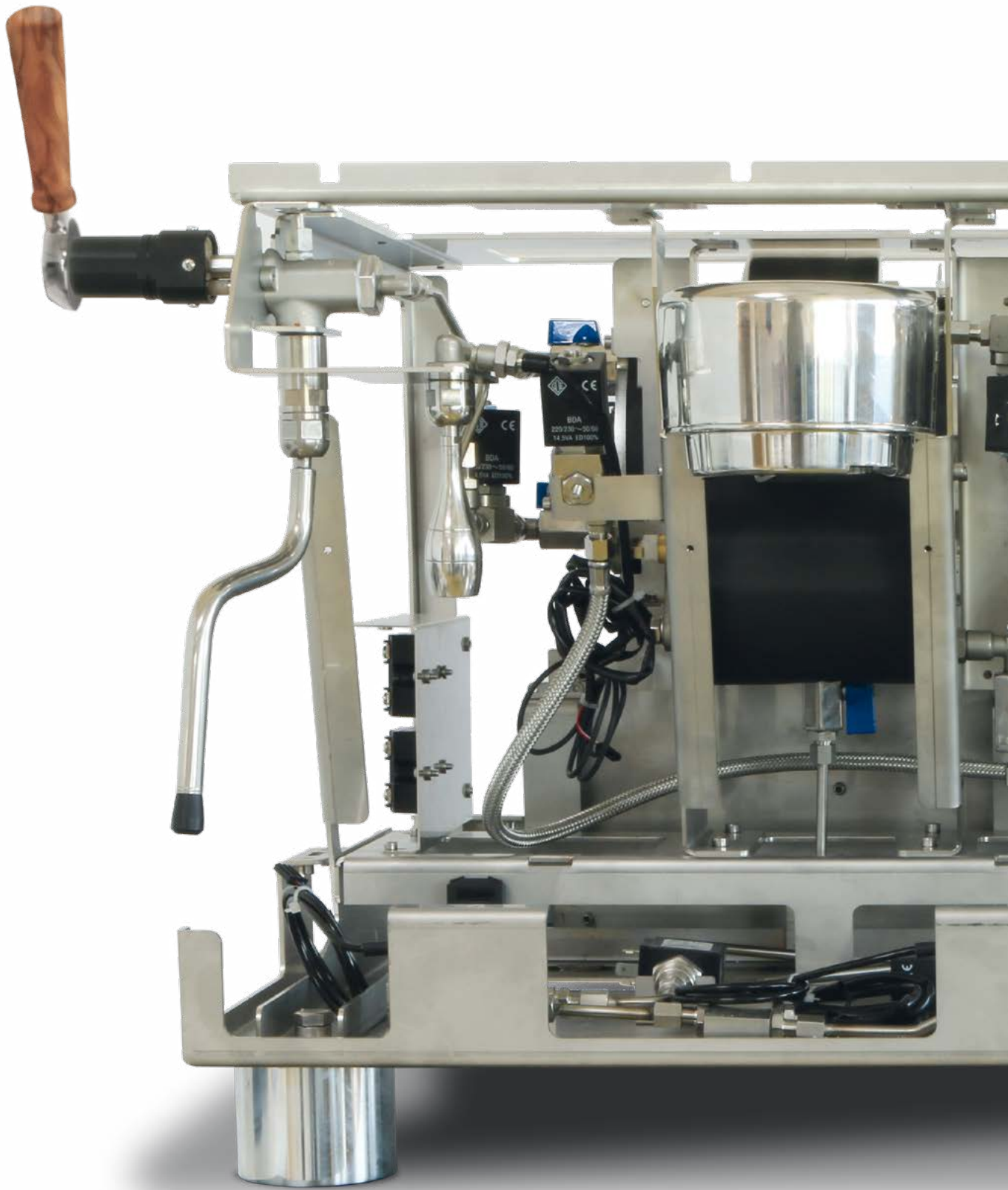







# tradition & future

Since 1962 in the espresso world

“ Endeavour, determination, passion and a love of work. These have been our values for over 57 years. Today, each and every one of the people who work in this firm does so with the same will and enthusiasm. ”



Follow us on Instagram!



(34) 93 475 02 58  
ascaso@ascaso.com  
www.ascaso.com

Coneixement 1, Pol. Ind. GavaPark - 08850 - Gavá - Barcelona - Spain



REICICLABLE



LIBRE FSC



save paper  
save tree

Technical specifications and models can change without notice.  
Las especificaciones técnicas y los modelos pueden cambiar sin notificación.